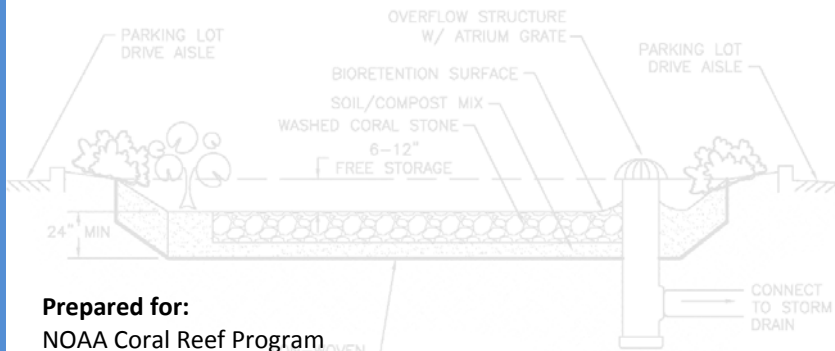


# ISLAND STORMWATER PRACTICE DESIGN SPECIFICATIONS

*A Supplement to the 2006 CNMI & Guam Stormwater Design Manual*

- Includes Specifications for:**
- (S1) Multi-Cell Ponding Basin
  - (S2) Island Bioretention
  - (S3) Permeable Parking & Walkways
  - (S4) Rainwater Harvesting
- Soil/Compost Mix for S1, S2, S3 Designs  
Field Test for Determining Hydraulic Conductivity

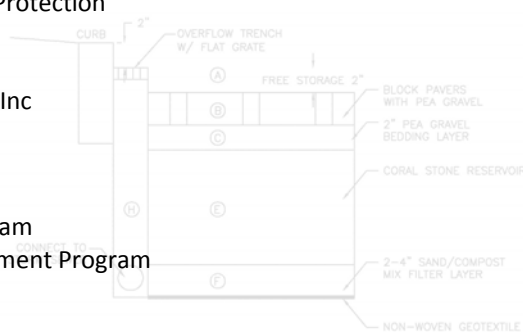


**Prepared for:**  
NOAA Coral Reef Program  
Guam Coastal Management Program  
Guam Environmental Protection Agency

**Prepared by:**  
Center for Watershed Protection  
Ellicott City, MD

Horsley Witten Group, Inc  
Sandwich, MA

**Funded by:**  
NOAA Coral Reef Program  
Guam Coastal Management Program



March 2010



## **ISLAND STORMWATER PRACTICE DESIGN SPECIFICATIONS** ***A Supplement to the 2006 CNMI & Guam Stormwater Design Manual***

The *CNMI and Guam Stormwater Design Manual* was produced by the Horsley Witten Group in 2006. Since that time, various efforts have taken place to incorporate the *Manual* into policy and practice on the islands.

The current effort expands on the *Manual* by adapting several of the designs to more typical island conditions. This includes using locally-available materials and incorporating design flexibility for wet and dry season conditions. The effort also involves introducing some additional innovative, “low-impact development,” practices that are recommended for the island environment.

A workshop was held in September, 2009 on Guam, conducted by the Center for Watershed Protection and the Horsley Witten Group, and sponsored by the Guam Coastal Management Program, Guam Environmental Protection Agency, and the National Oceanographic and Atmospheric Administration, Coral Reef Program. The purpose of the workshop was to examine how to adapt better site design and low-impact development to Guam, and to receive structured feedback on four innovative stormwater practices. The four specifications contained in this supplement are an outcome from that workshop, and the specifications incorporate feedback received from participants, both during and after the workshop.

The specifications include four practices, plus two additional “general” specifications that are relevant to the four practices. The specifications include:

- (S1) Multi-Cell Ponding Basin
- (S2) Island Bioretention
- (S3) Permeable Parking & Walkways
- (S4) Rainwater Harvesting
- Soil/Compost Mix for S1, S2, S3 Designs
- Field Test for Determining Hydraulic Conductivity (Infiltration Testing)

Future work may include expanding the list of “island-adapted” practices and seeking demonstration sites on the island to implement the innovative practices.

# Island BMP Specification #1: Multi-cell Ponding Basin



## **Island BMP Specification #1: Multi-cell Ponding Basin**

***Supplemental Design Criteria for the CNMI & Guam Stormwater Management Manual, 2006. To be added as supplement to Volume 1, Chapter 3.***

### **Section S1.1. Introduction**

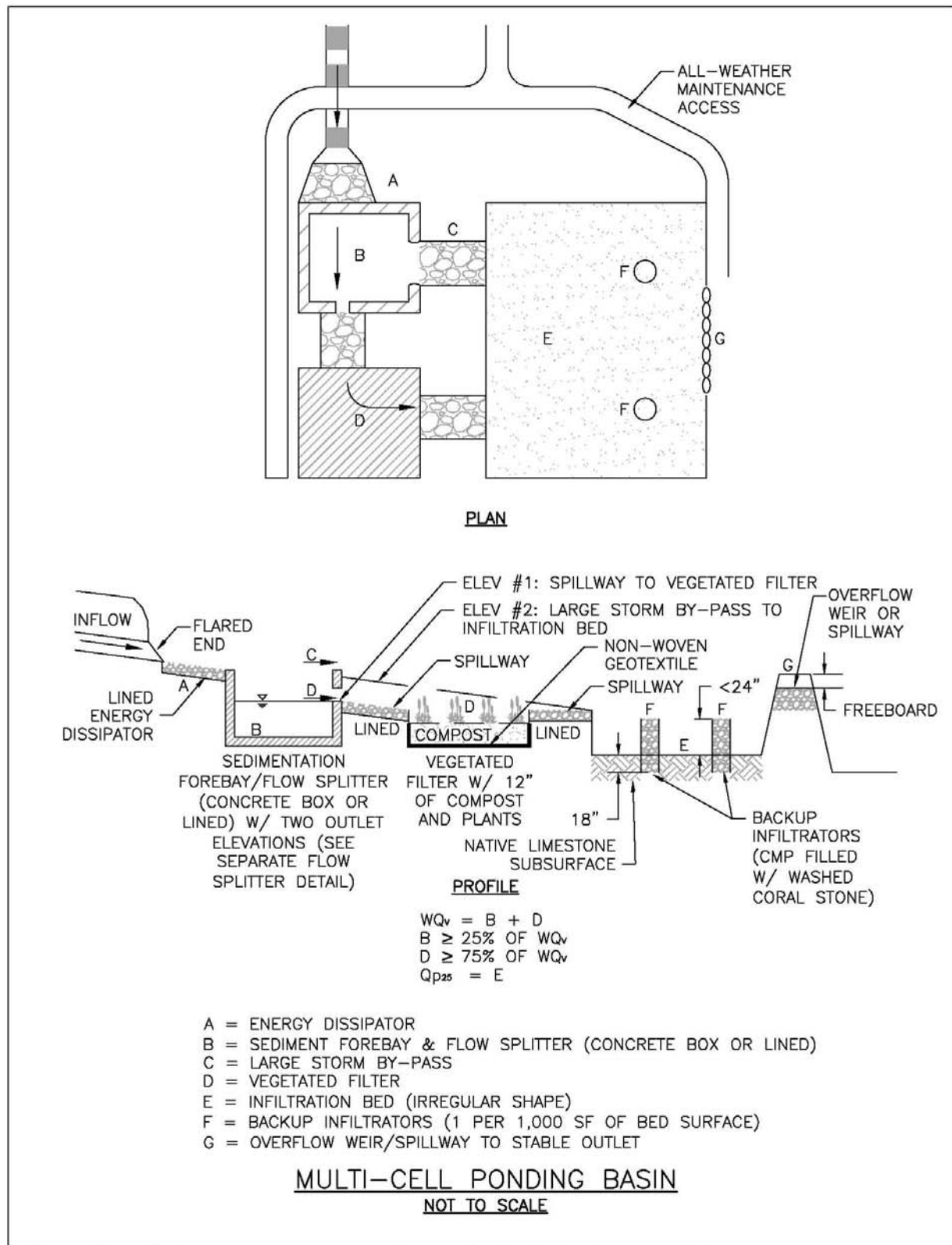
This specification adapts the most commonly used stormwater practice in the limestone regions of CNMI and Guam (the “ponding basin”) to meet the water quality requirements of the *Manual*. The adaptations involve incorporating multiple cells in order to manage all of the required sizing criteria. Whereas a ponding basin constructed in limestone generally provides recharge (until clogging occurs) and manages runoff volumes for large storm events, it does not provide water quality treatment and is not acceptable as a stand-alone system under the requirements of the *Manual*. However, by adding a pretreatment and a filter cell to the system, all requirements can be met.

This system combines the concepts of bioretention (see Island Bioretention specification) as well as infiltration (see Volume I, Chapter 3 of the *Manual*) to meet all of the stormwater management goals. Multi-cell ponding basins are very versatile because the multiple cells can be designed with varying geometry to fit into different development sites. This system is generally suitable for most land uses, as long as the drainage area is limited to a maximum of about ten acres.

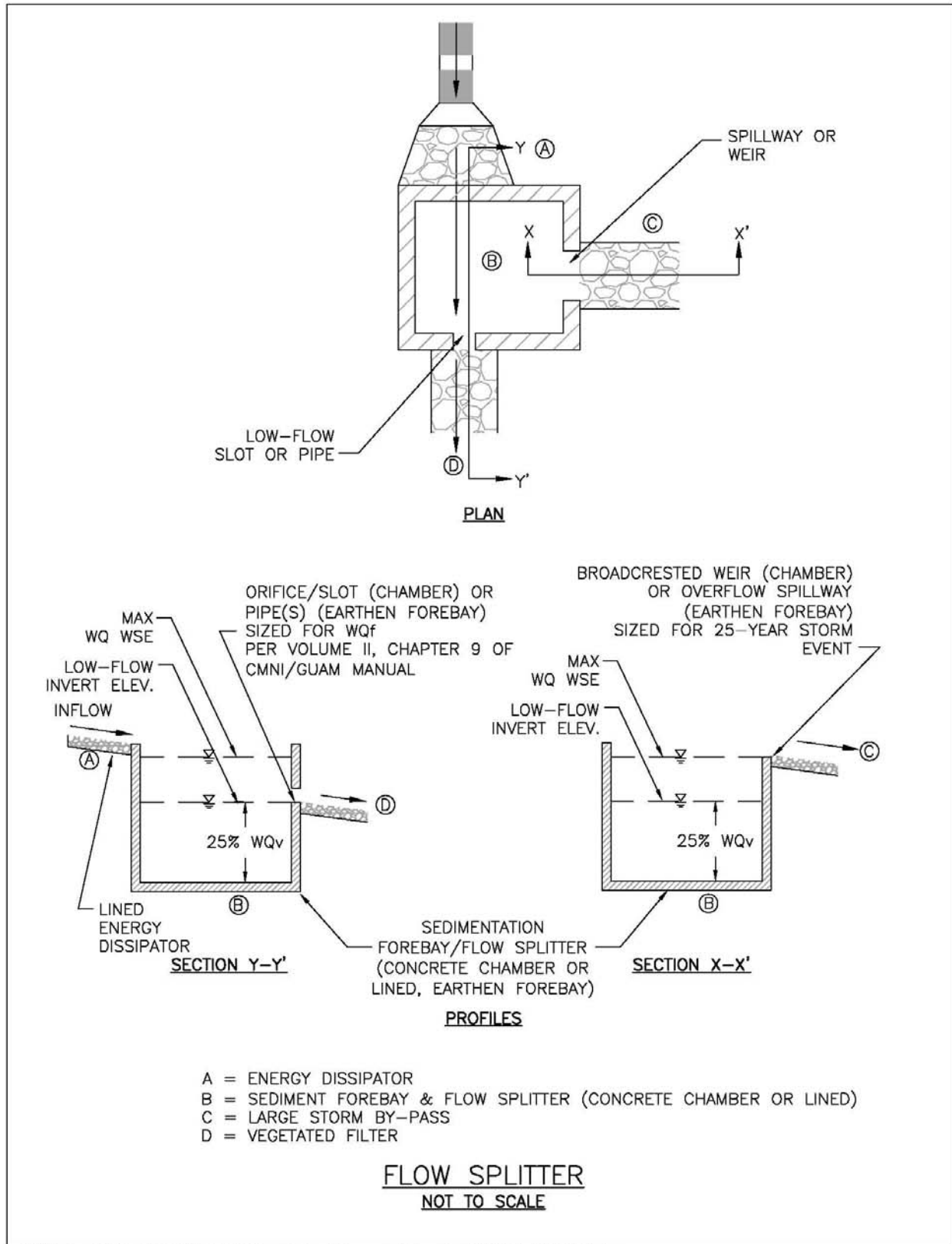
**Table S1.1** provides details and notes for each of the multi-cell ponding basin design components shown in the typical details (see **Figures S1.1** and **S1.2**).

Treatment Suitability: Multi-cell ponding basin designs are flexible and can be designed to manage the recharge volume ( $Re_v$ ), water quality volume ( $WQ_v$ ), channel protection volume ( $Cp_v$ ), and the overbank flood storage ( $Q_{p-25}$ ).

## Section S1.2. Typical Details



**Figure S1.1. Plan View and Longitudinal Section for Multi-cell Ponding Basin.**



**Figure S1.2. Flow Splitter Detail. See Figure S1.1 for location of flow splitter in the multi-cell ponding basin system.**

<b>Table S1.1. Description of Multi-cell Ponding Basin Design Components</b>		
<b>Material</b>	<b>Specification</b>	<b>Notes</b>
Energy Dissipator (A) and Spillway (C and G) Stone	<ul style="list-style-type: none"> <li>• Use riprap or other available hard, angular stone of appropriate size, such as clean, washed coral stone; (minimize amount of coral “dust”) or washed, broken concrete.</li> <li>• Place at inlets and along spillways to dissipate energy and prevent erosion</li> </ul>	Size riprap or acceptable alternative per Federal Highway Admin. criteria based on the peak velocity from the 10-year storm event.
Geotextile or Filter Fabric for Lining the Energy Dissipator (A) and Spillway (C)	<ul style="list-style-type: none"> <li>• Filter fabric or equivalent.</li> <li>• Place as shown on the typical detail in <b>Figure S1.1</b>.</li> </ul>	
Sedimentation Forebay/Flow Splitter (B)	<ul style="list-style-type: none"> <li>• Shown in greater detail in <b>Figure S1.2</b>.</li> <li>• Construct in concrete box or earthen forebay with riprap (or alternative) and impermeable liner.</li> <li>• Size for 25% <math>WQ_v</math></li> <li>• Outlet orifice/slot (if concrete box) or pipe (if earthen forebay) to filter bed (D) should be sized based on <math>WQ_f</math> (see <b>Section S1.4</b>).</li> <li>• Outlet weir (if concrete box) or spillway (if earthen forebay) for the large storm by-pass (C) should be sized based on the <math>Q_{p-25}</math></li> </ul>	The sedimentation forebay/flow splitter provides pretreatment for the filter bed (D) as well as a bypass (C) for larger storm flows to prevent overwhelming the filter bed.
Impermeable Liner (for use with an earthen forebay)	<ul style="list-style-type: none"> <li>• Use a thirty mil (minimum) PVC Geomembrane liner covered by 8 to 12 oz./sq. yd. non-woven geotextile to protect the liner from puncture.</li> </ul>	Use impermeable liners to line the forebay/flow splitter (B) if a concrete structure is not used.
Soil/Compost Media for Vegetated Filter Bed (D)	<ul style="list-style-type: none"> <li>• Follow guidance in Soil Compost Media specification</li> <li>• Minimum 12” in vegetated filter cell</li> <li>• Filter bed surface should generally be flat to promote uniform filtration across the surface.</li> </ul>	Other compost media or sand mixtures may be substituted if tested and approved by the plan-approving authority

Table S1.1. Description of Multi-cell Ponding Basin Design Components		
Material	Specification	Notes
Geotextile for Lining the Vegetated Filter Bed (D)	<ul style="list-style-type: none"> <li>• Needle-punched, non-woven geotextile fabric with a flow rate &gt; 110 gal./min./sq. ft. (e.g., Geotex 351 or equivalent).</li> <li>• Place as shown on the typical detail in <b>Figure S1.1</b>.</li> <li>• If an underdrain is used for the vegetated filter bed, place geotextile between the soil/compost media and the underdrain stone.</li> </ul>	Do NOT place impermeable liners between soil/compost and underdrain stone.
Free Storage Above Filter Bed (D)	<ul style="list-style-type: none"> <li>• 6 – 12”, with 6” recommended</li> </ul>	Control ponding level with outlet invert to the infiltration bed (E).
Plant Materials for Vegetated Filter Bed (D)	<ul style="list-style-type: none"> <li>• Plant mix of herbaceous, shrub, and tree species in the vegetated filter bed. Choose species from the Island Bioretention plant list (see <b>Section S2.7</b>)</li> </ul>	<p>Establish plant materials as specified in the landscaping plan and the recommended plant list.</p> <p>In general, plant spacing must be sufficient to ensure the plant material achieves 80% cover in the proposed planting areas within a 2-year period.</p> <p>It is recommended to plant trees around the perimeter of the filter bed, so that the trees drop vegetative matter on the filter surface to serve as a “self-mulching” mechanism.</p>



<b>Table S1.1. Description of Multi-cell Ponding Basin Design Components</b>		
<b>Material</b>	<b>Specification</b>	<b>Notes</b>
Underdrains & Cleanouts (only for filter bed designs in poor soils – not shown in <b>Figure S1.1</b> ) (D)	<ul style="list-style-type: none"> <li>• 4 – 6” inch rigid schedule 40 PVC pipe (or equivalent corrugated HDPE for small applications)</li> <li>• 3/8” perforations at 6 inches on center</li> <li>• Perforations only below filter bed</li> <li>• Minimum slope = 0.5%; 1% recommended</li> <li>• Position underdrain pipes ≤ 20’ apart</li> <li>• Clean-outs non-perforated &amp; tied to underdrain with elbow; all clean-outs capped at surface</li> </ul>	<p>Only use underdrains when soils in filter bed area have slow infiltration rates. Underdrains must discharge to infiltration bed (E).</p> <p>Lay the perforated pipe under the length of the filter bed, and install non-perforated pipe as needed to connect with the downstream infiltration bed. Install T’s and Y’s as needed, depending on the underdrain configuration. Extend cleanout pipes to the surface with vented caps.</p>
Underdrain Coral Stone Layer (only for filter bed designs in poor soils - not shown in <b>Figure S1.1</b> ) (D)	<ul style="list-style-type: none"> <li>• Clean, washed coral stone; minimize amount of coral “dust” (very fine particles)</li> <li>• Place underdrain pipe in 8” of underdrain stone</li> </ul>	This layer serves as an underdrain in cases where soils under the filter bed have slow infiltration rates.
Infiltration Bed (E)	<ul style="list-style-type: none"> <li>• Size for managing <math>Q_{p-25}</math></li> <li>• Excavate basin into native limestone subsurface with high infiltration rates</li> <li>• Provide an overflow weir or spillway (G) for storms &gt; 25-year event</li> </ul>	Designer must perform infiltration testing at site to determine infiltration rate to use for sizing bed. See on-site infiltration test guidance in this supplement.
Backup Infiltrator (F)	<ul style="list-style-type: none"> <li>• Use ≥24” CMPs or RCPs set vertically in the infiltration bed (E) with a maximum top elevation at 24” above the infiltration bed and a minimum of 18” deep into the native limestone subsurface.</li> <li>• Fill with clean, washed coral stone; minimize amount of coral “dust” (very fine particles)</li> </ul>	These are provided as emergency backup in case the infiltration bed becomes clogged. They should be placed at a rate of 1 per 1,000 square feet of bed surface. Designer should consult underground injection control (UIC) regulations to determine regulatory status of design.
* Letters correspond to labels in <b>Figures S1.1 through S1.2</b> .		

## Section S1.3. Feasibility

Multi-cell ponding basin should generally be applied in limestone regions with high infiltration rates. Key considerations with multi-cell ponding basins include the following:

**Available Space.** Multi-cell ponding basins generally require more space than some of the other practices. However, there is flexibility with this design because the geometry of the different cells can be altered to fit a site, and the cells do not need to be adjacent to each other if connected hydraulically in other ways (an appropriately sized open channel or pipe system).

**Topography.** Ideally, the topography for the multi-cell ponding basin should be gently sloping. The concept is adaptable in that the energy dissipator/sediment forebay, vegetated filter, and infiltration bed can be at different locations on the site and/or terraced down a sloping site.

**Available Hydraulic Head.** The necessary head for the design is defined by the elevation difference between the energy dissipator (A) and the infiltration bed overflow weir (G). The site should have enough fall to drive stormwater through the system. If the filter bed design includes an underdrain, there must be enough fall for the underdrain to daylight into the infiltration bed.

**Water Table.** Multi-cell ponding basins should always be separated from the water table to ensure that groundwater does not intersect the filter bed. Mixing can lead to possible groundwater contamination or failure of the system. A minimum separation distance of 2 feet is recommended between the bottom of the excavated filter bed/infiltration bed and the seasonally high ground water table or other impermeable layer.

**Utilities.** Interference with underground utilities should also be avoided, particularly water and sewer lines. Local utility design guidance should be consulted in order to determine the horizontal and vertical clearance required between stormwater infrastructure and other dry and wet utility lines.

**Soils.** Soil conditions do not constrain the use of the multi-cell ponding basin, although they determine whether an underdrain is needed for the filter bed. Soils with slow percolation rates in Hydrologic Soil Groups (HSG) C or D usually require an underdrain, whereas HSG A or B soils generally do not. If an underdrain is necessary, it must discharge to the downstream infiltration bed. However, the underlying geologic material (limestone vs. volcanic) is very important for determining the applicability of this practice. When designing a multi-cell ponding basin, designers should verify soil and limestone permeability by using the on-site soil investigation methods outlined in the *Manual* and this supplement.

**Contributing Drainage Area.** Multi-cell ponding basins are less restrictive than some systems because the filter bed is designed as an off-line system that only receives the flow from the smaller storm events, while larger flows bypass the filter to the infiltration bed. The maximum drainage area to this system is generally 10 acres.

**Floodplains.** Multi-cell ponding basins should be constructed outside the limits of the ultimate 100-year floodplain.

**No Irrigation or Baseflow.** The multi-cell ponding basin should not receive baseflow, irrigation water, chlorinated wash-water or other such non-stormwater flows that are not stormwater runoff.

**Setbacks.** To avoid the risk of seepage, do not allow multi-cell ponding basins to be hydraulically connected to structure foundations or pavement. At a minimum, multi-cell ponding basins should be located a horizontal distance of 100 feet from any water supply well, 50 feet from septic systems, and 5 feet from down-gradient wet utility lines. Dry utility lines such as gas, electric, cable and telephone may cross under multi-cell ponding basins if they are double-cased.

**Aesthetics.** Multi-cell ponding basin locations should be integrated into the site planning process, and aesthetic considerations should be taken into account in their siting and design.

## Section S1.4. Conveyance and Pretreatment

The sedimentation forebay/flow splitter provides pretreatment for the filter bed as well as a bypass for flows from larger storm events to prevent overwhelming the filter bed (see **Figures S1.1** and **S1.2**). The following criteria apply to these structures:

- Construct in either (1) concrete box or (2) earthen forebay with riprap (or alternative) and impermeable liner.
- Size the storage below the low-flow outlet for 25%  $WQ_v$  and a 1.5:1 length-to-width ratio to provide appropriate pretreatment.
- Size the low-flow outlet orifice/slot (if concrete box) or pipe (if earthen forebay) to the vegetated filter bed based on  $WQ_f$  (see description below, as well as Volume II, Chapter 9 of *Manual*) and set the invert above the 25%  $WQ_v$  storage level.
- Size the large storm by-pass outlet weir (if concrete box) or spillway (if earthen forebay) based on the  $Q_{p-25}$  and set the invert above the maximum water surface elevation associated with the  $WQ_v$  storm event.

Energy dissipators should be used at the inlet to the sedimentation forebay/flow splitter as well as at the bypass spillway and overflow spillway from the infiltration basin so that velocities are non-erosive (i.e., to prevent downstream erosion).

Depending on the type and scale of the application, other pre-treatment options may be acceptable as long as the sizing criteria listed above are met.

### **Water Quality Flow ( $WQ_f$ )**

The water quality flow ( $WQ_f$ ) is the peak flow rate associated with the water quality design storm or  $WQ_v$ . Although most of the stormwater treatment practices in this manual are sized based on  $WQ_v$ , flow splitter structures (or diversions for off-line stormwater treatment practices) must be designed to bypass flows greater than the  $WQ_f$ . The  $WQ_f$  shall be calculated using the  $WQ_v$  described above and a modified curve number (CN) for small storm events. This is more appropriate than the traditional NRCS CN Methods and the Rational Formula, which have been widely used for peak runoff calculations and drainage design. The traditional NRCS TR-55 CN methods are valuable for estimating peak discharge rates for large storms (i.e., greater than 2 inches), but can significantly underestimate runoff from small storm events (Claytor and Schueler, 1996). This discrepancy in estimating runoff and discharge rates can lead to situations where a significant amount of runoff by-passes the water quality practice due to an inadequately sized diversion structure and leads to the design of undersized bypass channels. Similarly, the Rational Formula is highly sensitive to the time of concentration and rainfall intensity, and therefore should only be used with reliable intensity, duration, and frequency (IDF) tables or curves for the storm and region of interest (Claytor and Schueler, 1996).

The following equation shall be used to calculate a modified CN. This modified CN can then be used in a traditional TR-55 model or spreadsheet in order to estimate peak discharges for small storm events.

Using the water quality volume ( $WQ_v$ ), a corresponding CN is computed utilizing the following equation:

$$CN = 1000 / [10 + 5P + 10Q - 10(Q^2 + 1.25 QP)^{1/2}]$$

Where:

$P$  = design rainfall, in inches (use 1.5 inches for High Quality Water Resources; 0.8 inches for Moderate Quality Water Resources – see Volume I, Chapter 2 of the Manual)

$Q$  = runoff amount, in watershed inches (equal to  $WQ_v \div$  total drainage area)

When using a hydraulic/hydrologic model for facility sizing and  $WQ_f$  determination, designers must use this adjusted CN for the drainage area to generate runoff equal to the  $WQ_v$  for the design precipitation event (1.5 or 0.8 inches).

Designers can also use a TR-55 spreadsheet to find the  $WQ_f$ . Using the computed CN from the equation above, the time of concentration ( $t_c$ ), and drainage area ( $A$ ); the peak discharge ( $WQ_f$ ) for the water quality storm event can be computed with the following steps:

1. Read initial abstraction ( $I_a$ ) from TR-55-Table 4.1 or calculate using  $I_a = 200/CN - 2$
2. Compute  $I_a/P$  ( $P = 1.5$  or  $0.8$  inches)
3. Approximate the unit peak discharge ( $q_u$ ) from TR-55 Exhibit 4-III using  $t_c$  and  $I_a/P$
4. Compute the peak discharge ( $WQ_f$ ) using the following equation:

$$WQ_f = q_u * A * Q$$

Where:

$WQ_f$  = the peak discharge for water quality event, in cfs

$q_u$  = the unit peak discharge, in cfs/mi<sup>2</sup>/inch

$A$  = drainage area, in square miles

$Q$  = runoff amount, in watershed inches (equal to  $WQ_v \div A$ )

## Section S1.5. Treatment

See **Table S1.1** for details and notes for each multi-cell ponding basin design component. This section provides further information on the filter bed and infiltration bed sizing, soil/compost media, and infiltration testing.

### Sizing for the Multi-cell Ponding Basin

Sizing for the multi-cell ponding basin involves calculating the required storage volumes for the criteria that it will be designed to manage: recharge volume ( $Re_v$ ), water quality volume ( $WQ_v$ ), channel protection volume ( $Cp_v$ ), and/or overbank flood storage ( $Q_{p-25}$ ). These storage volumes must be allocated to the various layers within the multi-cell ponding basin.

- The forebay and filter bed should be sized for 75% of the  $WQ_v$  per Volume I, Chapter 3 of the *Manual*.

- The  $Re_v$  will be met either in the infiltrating filter bed or in the infiltration basin itself. There is no need to perform separate calculations for the  $Re_v$  for this system.
- The infiltration bed should be sized based on the storage volume required for  $Q_{p-25}$

The storage and sizing equation for filter bed is as follows (no underdrain):

$$\text{Required Storage} = 0.75 \times WQ_v \leq V_{sb} + V_{fs} + V_s$$

Where:

$V_{sb}$  = Storage volume of sedimentation basin/flow splitter (see **Section S1.4**) = volume of storage x 1.0

$V_{fs}$  = Storage volume of free storage above the vegetated filter = free storage x 1.0

$V_s$  = Storage volume of soil/compost layer in the vegetated filter = volume of soil/compost x 0.25

The storage and sizing equation for the infiltration bed is as follows (assuming filter bed has no underdrain, and thus, the whole  $WQ_v$  is infiltrated in the filter bed):

$$\text{Required Storage} = Q_{p-25} - WQ_v \leq V_{ib} + (SA_{ib} \times f_c \times T / 12)$$

Where:

$Q_{p-25}$  = Storage volume required for overbank flood control (cubic feet)

$V_{ib}$  = Storage volume of infiltration bed (cubic feet) = volume of storage x 1.0

$SA_{ib}$  = Surface area of the bottom of the infiltration bed (square feet). Do not count sidewalls in sizing.

$f_c$  = Design infiltration rate of the native limestone subsurface (inches/hour). Designers should always decrease the measured infiltration rate by a factor of 2 during design to approximate clogging over the long-term.

$T$  = Time to fill basin (hours). Assume to be 2 hours for design purposes per Volume I, Chapter 3 of the Manual.

12 = Conversion factor to convert inches/hour to feet/hour.

### Soil/Compost Media

It will be necessary to find a suitable soil/compost mix for the filter bed portion of the multi-cell ponding basin. This mix will likely come from a topsoil vendor or other local source. Guidelines for creating and testing the soil/compost mix are detailed in the Soil/Compost Mix specification as part of this supplement.

### Infiltration Rate Testing

It will be necessary to conduct infiltration testing to determine infiltration suitability and the  $f_c$  used in sizing (see above). Guidelines for conducting the infiltration test are included in this supplement.

## Section S1.6. Landscaping/Planting Plan

The following landscaping/planting plan guidance is provided for the vegetated filter bed:

- A dense, healthy vegetative cover should be established over the contributing pervious drainage areas before runoff can be accepted into the practice.
- Landscaping is critical to the performance and function of the filter bed. Therefore, a landscaping plan must be provided (see **Table S2.2** in the Island Bioretention specification for recommended plants).

- Planting recommendations for the vegetated filter bed are as follows:
  - Native plant species should be specified over non-native species when possible.
  - Vegetation should be selected based on a specified zone of hydric tolerance, with “wetter” species in the bottom and “drier” species around the edges of the filter bed.
  - The emphasis of the planting plan should be to cover the surface area of the filter bed in a short amount of time. Most of the species should be herbaceous, with relatively small trees or shrubs around the perimeter.
  - Woody vegetation should not be specified at inflow locations.
  - Trees should not be planted directly on top of underdrains, if used, and may best be located along the perimeter of the practice.

## Section S1.7. Construction Sequence

This section provides a typical construction sequence. However, the actual sequence will depend on site conditions and the location of the system in relation to other areas of the site that are under construction. ***In all cases, it is important to prevent construction sediment from entering the multi-cell ponding basins.***

1. If not used as a temporary settling basin during construction (see #2 below), multi-cell ponding basins should remain outside the limit of disturbance during construction to prevent soil compaction by heavy equipment.
2. Excavators or backhoes working adjacent to the proposed area should excavate the infiltration bed within 24” of the appropriate design depth. This area may be used as a temporary settling basin during construction, as long as the final design invert of the infiltration bed is below the invert used for the settling basin AND all construction sediment is removed prior to conversion. Equipment should stay out of the infiltration bed area to prevent compaction. The proposed site should be checked for existing utilities prior to any excavation.
3. Install the sedimentation basin/flow splitter (or approved pretreatment measures) and the conveyance spillways, but block the low-flow outlet until the filter bed is constructed and stabilized, only allowing runoff to enter the temporary settling basin.
4. PREMATURE INSTALLATION OF VEGETATED FILTER BED DURING CONSTRUCTION IS THE #1 CAUSE OF PRACTICE FAILURE. The proposed site should be checked for existing utilities prior to any excavation. It may be necessary to install temporary erosion and sediment control measures (e.g., silt fence) around the perimeter of filter bed construction areas to keep sediment from side slopes and the drainage area out of the filter bed area.
5. Excavators or backhoes working adjacent to the proposed filter bed area should excavate to the appropriate design depth. Equipment should stay out of the filter bed area. It is recommended to “rip” or loosen the underlying native soil to promote better infiltration.
6. Install the underdrain system if included in the design (including clean-outs outfall to infiltration bed). Cover the underdrain layer with needle-punched, non-woven geotextile.
7. Place the approved soil/compost mix, applying in 12-inch lifts until the desired top elevation is achieved. It may be necessary to wait a few days to check for settlement, and add additional media as needed.

8. Install the plant materials in the filter bed as per approved plans, and irrigate accordingly to ensure survival.
9. Once the filter bed is constructed and stabilized (vegetation is growing and healthy), the low-flow outlet from the sedimentation basin/flow splitter may be un-blocked, bringing the filter bed on-line.
10. Clean-out and remove any construction sediment from the infiltration bed location. Excavators or backhoes working adjacent to the proposed infiltration bed shall finish excavating to the design depth, and the backup infiltrators and overflow spillway should be installed. Equipment should stay out of the infiltration bed area to prevent compaction.
11. Conduct final construction inspection, checking inlet, pretreatment, spillways, filter bed, infiltration bed, backup infiltrators, and outlet elevations.

## Section S1.8. Maintenance

**Table S1.2** provides recommended maintenance activities and frequencies for multi-cell ponding basins.

<b>Table S1.2. Recommended Maintenance Activities for Multi-cell Ponding Basins</b>	
<b>Activity</b>	<b>Schedule</b>
<ul style="list-style-type: none"> <li>• Pruning and weeding to maintain appearance.</li> <li>• Remove overgrowth of plant materials.</li> <li>• Remove plant debris that seems to be clogging the filter bed.</li> <li>• Remove trash and debris.</li> </ul>	As needed
<ul style="list-style-type: none"> <li>• Inspect inflow points for clogging. Remove build-up of sediment and debris.</li> <li>• Inspect overflow structure and remove sediment and debris.</li> <li>• Inspect plant materials for survival and replace any dead or severely diseased vegetation.</li> </ul>	Semi-annually, at beginning of wet and dry seasons
<ul style="list-style-type: none"> <li>• Inspect and remove any sediment and debris build-up in sedimentation forebay/flow splitter.</li> <li>• Inspect inflow points and filter bed for build-up of sediment and debris.</li> <li>• Inspect infiltration bed and backup infiltrators for signs of clogging.</li> <li>• Inspect all slopes and/or concrete structures for signs of erosion or failure.</li> </ul>	Annually, after wet season
<ul style="list-style-type: none"> <li>• Replace riprap if needed in the energy dissipator and/or spillways.</li> <li>• Remove the top layer of soil/compost mix in the filter bed if necessary and replace with clean material.</li> <li>• The planting soils should be tested for pH to establish acidic levels. If the pH is above 7.3, then iron sulfate plus sulfur can be added to reduce the pH.</li> </ul>	2 to 3 years
<ul style="list-style-type: none"> <li>• Replace or rehabilitate sedimentation forebay/flow splitter structure as needed.</li> <li>• Replace or rehabilitate filter bed materials if permanently clogged.</li> <li>• Rehabilitate infiltration bed if permanently clogged.</li> <li>• Clean out underdrains (if any) if clogged with roots or debris.</li> </ul>	Infrequently, as needed

**References:**

Claytor, R. and T. Schueler. 1996. Design of Stormwater Filtering Systems. Center for Watershed Protection. Ellicott City, MD.



**Multi-cell Ponding Basins**



**Description:** This is a variation on the commonly used ponding basin. It is a multiple-celled system that combines pretreatment, a filter bed, and infiltration to meet all of the required sizing criteria.

**Design practices:** Multi-cell Ponding Basins (Supplement #1)

<p style="text-align: center;"><u>KEY CONSIDERATIONS</u></p> <p><b>CONVEYANCE</b></p> <ul style="list-style-type: none"> <li>• Conveyance to the system is typically through energy dissipator.</li> <li>• Provide low-flow outlet based on <math>WQ_v</math> to vegetated filter bed.</li> <li>• Provide bypass to infiltration bed for flows larger than the design flow.</li> </ul> <p><b>PRETREATMENT</b></p> <ul style="list-style-type: none"> <li>• Pretreatment consists of a sedimentation forebay/flow splitter or equivalent practice described in <b>Section S1.4</b>.</li> </ul> <p><b>TREATMENT</b></p> <ul style="list-style-type: none"> <li>• Filter bed should have a soil/compost layer and a 6 - 12” ponding layer.</li> <li>• Size the treatment area and infiltration bed using equations provided in <b>Section S1.5</b>.</li> </ul> <p><b>LANDSCAPING</b></p> <ul style="list-style-type: none"> <li>• Detailed landscaping plan required.</li> <li>• Recommended plant list in <b>Section S2.7</b>.</li> </ul> <p><b>MAINTENANCE REQUIREMENTS:</b></p> <ul style="list-style-type: none"> <li>• See maintenance activities and frequencies in <b>Section S1.8</b>.</li> </ul>	<p style="text-align: center;"><u>STORMWATER MANAGEMENT SUITABILITY</u></p> <ul style="list-style-type: none"> <li><input checked="" type="checkbox"/> <b>Water Quality</b></li> <li><input checked="" type="checkbox"/> <b>Recharge</b></li> <li><input checked="" type="checkbox"/> <b>Channel Protection</b></li> <li><input checked="" type="checkbox"/> <b>Overbank Flood</b></li> </ul> <p><b>Accepts Hotspot Runoff:</b> Yes, if filter bed has impermeable liner and underdrain system</p> <p style="text-align: center;"><u>IMPLEMENTATION CONSIDERATIONS</u></p> <ul style="list-style-type: none"> <li><input type="checkbox"/> <b>Capital Cost</b></li> <li><input type="checkbox"/> <b>Maintenance Burden</b></li> </ul> <p>Residential/Subdivision Use: <i>Yes</i>            High Density/Ultra-Urban: <i>No</i>            Drainage Area: <i>10 acres max.</i>            Soils: <i>Soil/Compost Mix created as per specification in the Manual supplement.</i></p> <p>Other Considerations:  <b>Use of native plants is recommended</b></p> <div style="border: 1px solid black; padding: 5px; text-align: center;">             Key: L=Low M=Moderate H=High           </div>
--	---

**POLLUTANT REMOVAL**

- |   |
|---|
| G |
|---|

 Phosphorus
- |   |
|---|
| G |
|---|

 Nitrogen
- |   |
|---|
| G |
|---|

 Metals - Cadmium, Copper, Lead, and Zinc removal
- |   |
|---|
| F |
|---|

 Pathogens - Coliform, *Streptococci*, *E. coli* removal

Key: G=Good F=Fair P=Poor

## Island BMP Specification #2: Island Bioretention



## **Island BMP Specification #2: Island Bioretention**

***Supplemental Design Criteria for the CNMI & Guam Stormwater Management Manual, 2006. To be added as supplement to Volume 1, Chapter 3. This specification substantially replaces 3.2.4.4: F-3 in the existing Manual.***

### **Section S2.1. Introduction**

Bioretention areas are suitable for most land uses, so long as the drainage area is limited to a maximum of about five acres. Common bioretention opportunities include landscaping islands, cul-de-sacs, parking lot margins, commercial setbacks, and street scapes (i.e., between the curb and sidewalk). **Figure S2.1** shows some typical bioretention applications. Bioretention is extremely versatile because of its ability to be incorporated into landscaped areas.

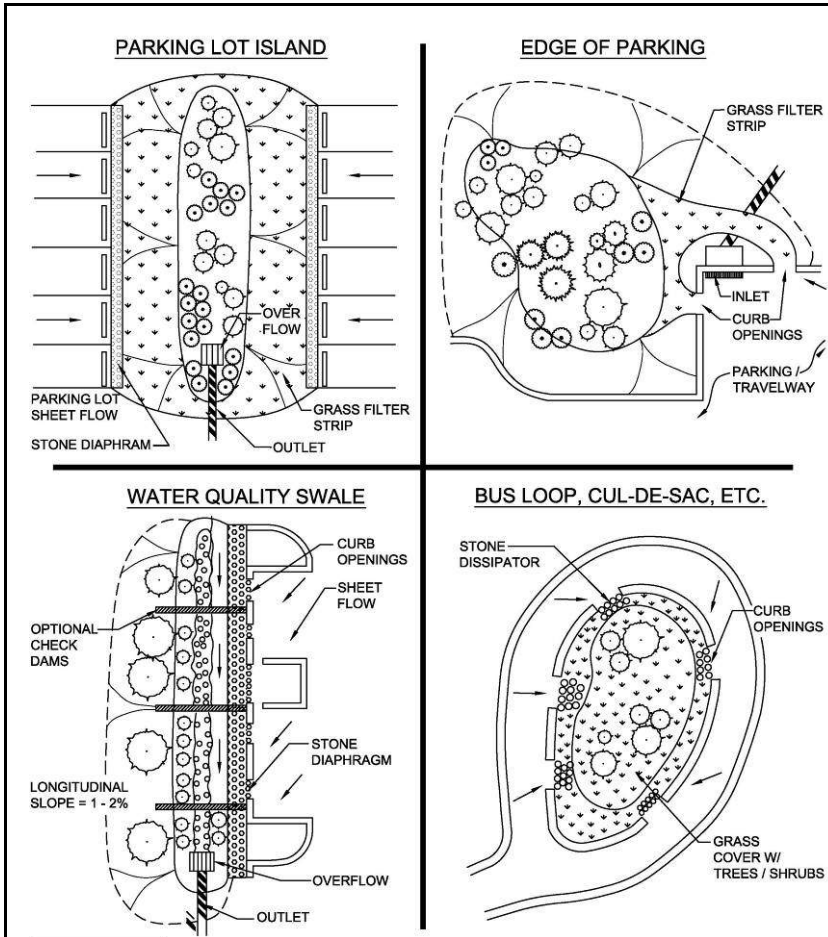
Bioretention was developed in the Mid-Atlantic mainland area and was originally designed to replicate the pollutant removal mechanisms of a forested ecosystem. Since that time, the concept has been adapted to other regions and climates. This specification adapts the concept of bioretention to the tropical island environment of CNMI and Guam. The adaptations involve substituting native materials for filter bed components that are unavailable and would be expensive to import, modifying designs to account for wet and dry seasons, and specifying locally available plant materials. **Figure S2.2** shows a coral stone filter on Guam that incorporates some of the design adaptations.

There are two basic design adaptations for “Island Bioretention”:

1. **Infiltration Design:** Design without an underdrain for sites where soil testing indicates suitable infiltration rates, relatively low water tables, and a low risk of groundwater contamination (e.g., not located at a stormwater hotspot). See **Figures S2.3** and **S2.4** for typical details of the infiltration design. Note that the typical details show a parking lot island application, but other configurations (e.g., edge of parking lot, residential cul-de-sac, etc.) are also encouraged.
2. **Filter Design:** Design with an underdrain for sites where native soils do not percolate as readily (less than ½ inch per hour). These designs still incorporate some level of infiltration, especially during the dry season, by providing a stone “sump” below the underdrain pipe. See **Figures S2.5** and **S2.6** for typical details of the filter design. Once again, the parking lot island is used for the typical detail, but other configurations are possible.

**Table S2.1** provides details and notes for each of the Island Bioretention design components shown in the typical details.

Treatment Suitability: Island Bioretention designs are flexible and can be designed to manage the recharge volume ( $Re_v$ ), water quality volume ( $WQ_v$ ), channel protection volume ( $Cp_v$ ), and/or overbank flood storage ( $Q_{p-25}$ ). However, customary designs address only the  $Re_v$  and  $WQ_v$ , with other downgradient practices managing the larger volumes associated with the  $Cp_v$  and  $Q_{p-25}$ . Some level of control for larger storms can be built into bioretention design by increasing the ponded surface area and/or the depth of the soil/compost mix and coral stone layers.

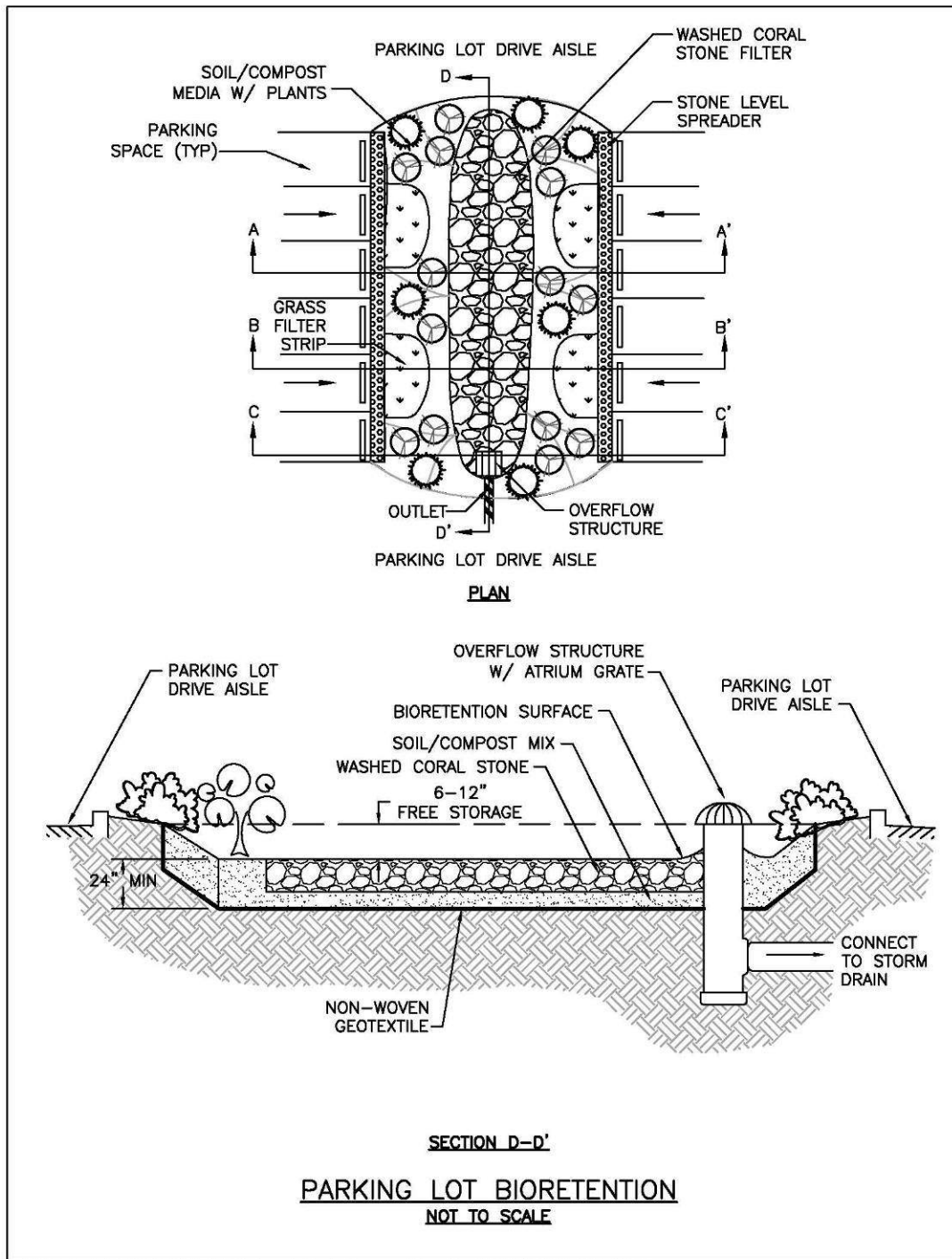


**Figure S2.1. Example applications for bioretention**



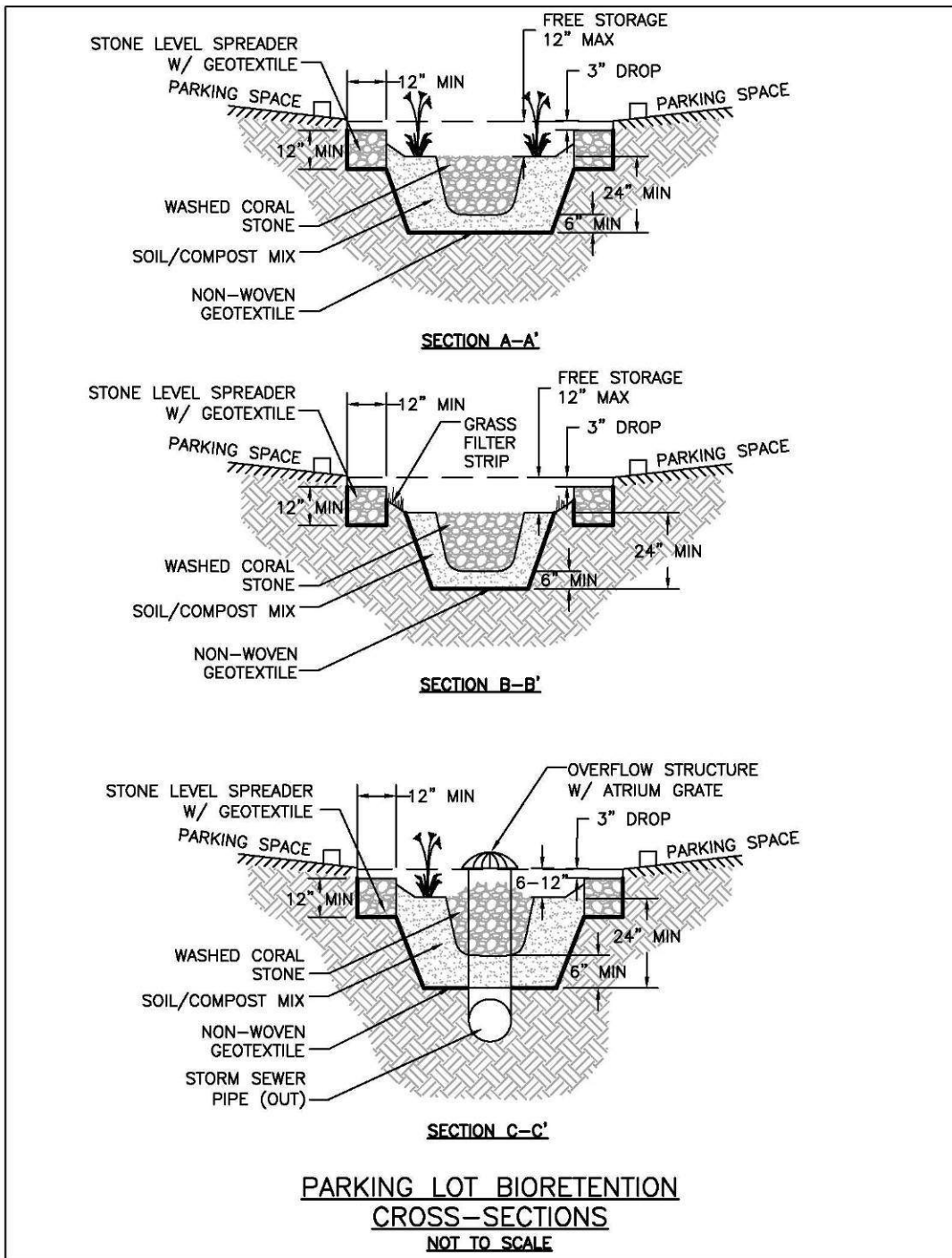
**Figure S2.2. Coral stone filter in a parking lot  
(Note: designs built according to this specification would likely be wider and incorporate additional materials)**

## Section S2.2. Typical Details



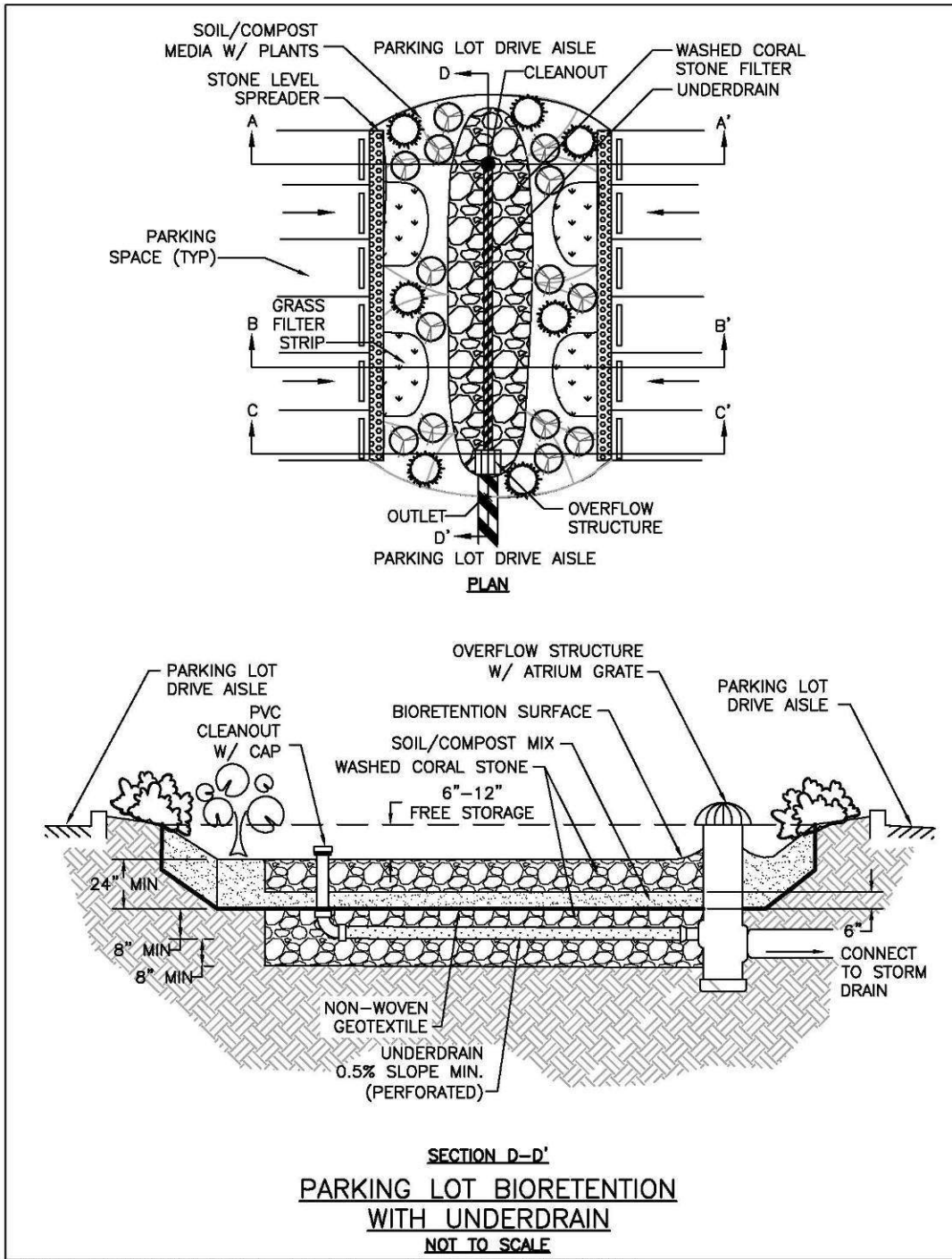
H:\Projects\2009\9039 NOAA Coral Reef Program\Drawings\ISLAND BIO NO UD.dwg

**Figure S2.3. Plan view and longitudinal section for infiltration design version (no underdrain).**



H:\Projects\2009\9039 NOAA Coral Reef Program\Drawings\ISLAND BIO NO UD.dwg

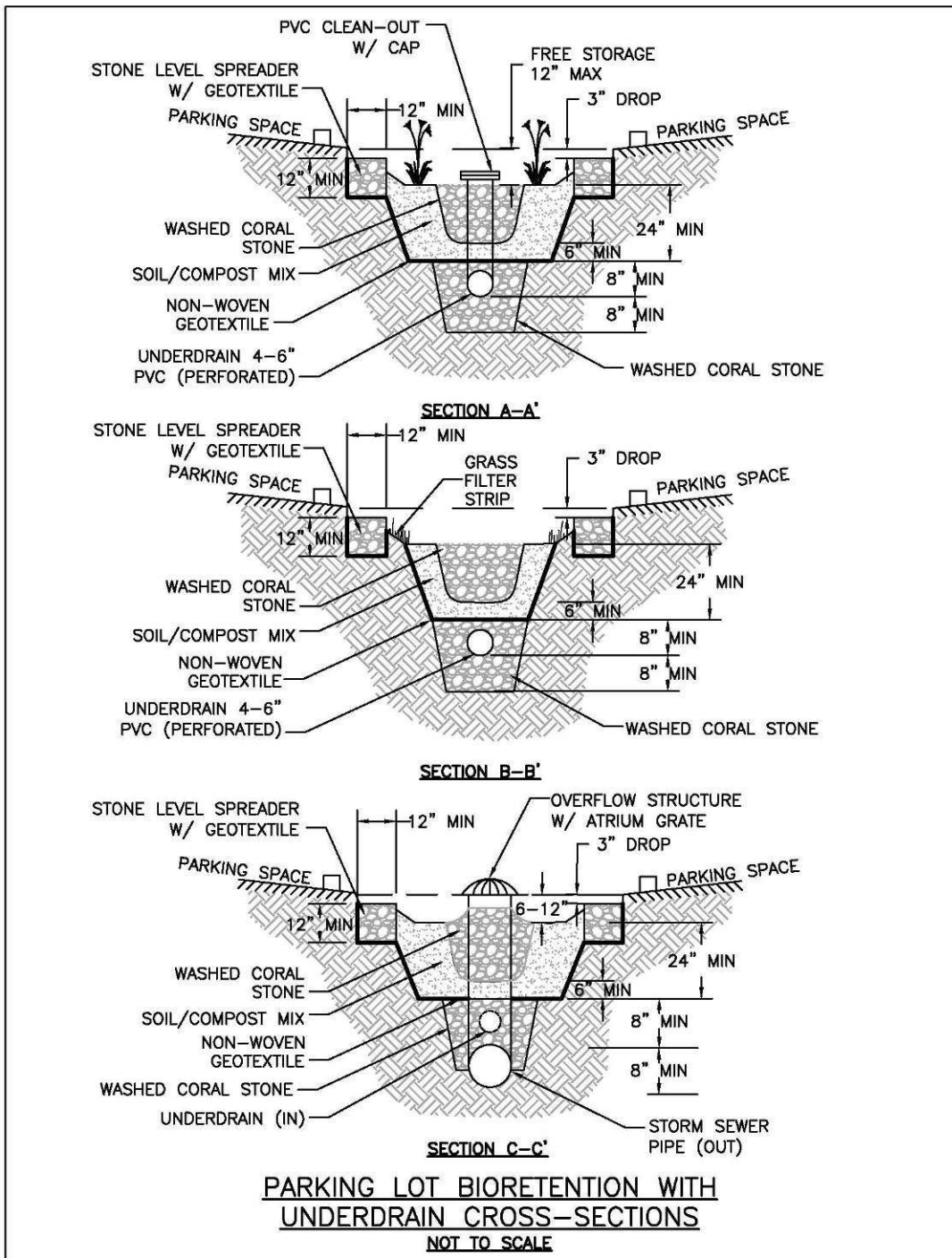
**Figure S2.4. Cross-sections for *infiltration* design version (no underdrain). See Figure S2.3 (top) for location of cross-sections.**



H:\Projects\2009\9039 NOAA Coral Reef Program\Drawings\ISLAND BIO W UD.dwg

**Figure S2.5. Plan view and longitudinal section for filter design version (includes underdrain).**





H:\Projects\2009\9039 NOAA Coral Reef Program\Drawings\ISLAND BIO W UD.dwg

**Figure S2.6. Cross-sections for filter design version (includes underdrain). See Figure S2.5 (top) for location of cross-sections.**

**Table S2.1. Description of Island Bioretention Design Components  
(see Figures S2.3 through S2.6)**

Material	Specification	Notes
Stone Level Spreader	<ul style="list-style-type: none"> <li>• Clean, washed coral stone, sized for inflow rate</li> <li>• Minimum 12" wide &amp; 12" deep</li> <li>• Non-woven geotextile underneath</li> <li>• Top of stone 3" below pavement elevation</li> <li>• Construct in concrete box if drainage area &gt; 1 acre</li> </ul>	See Section S2.5 for other pretreatment options. Larger drainage areas and inflow rates may require pretreatment cell or stone forebay
Grass Filter Strip	<ul style="list-style-type: none"> <li>• Minimum 2' wide</li> <li>• 5:1 maximum slope</li> <li>• Does NOT need soil/compost mix underneath</li> <li>• Grass filter strip surface area ≤ 25% of total free storage ponded area</li> </ul>	Grass filter strips help with pretreatment and can also be used to increase ponding surface area to enhance free storage
Free Storage Above Filter Bed	<ul style="list-style-type: none"> <li>• 6 – 12", with 6" recommended</li> </ul>	Control ponding level with overflow structure, or bypass higher flows to drop inlet in parking lot
Soil/Compost Media	<ul style="list-style-type: none"> <li>• Follow guidance in Soil Compost Media specification</li> <li>• Place on sides and underneath coral stone filter so that all flow passes through soil/compost; minimum thickness of 6" below coral stone</li> </ul>	Other compost media or sand mixtures may be substituted if tested and approved by the plan-approving authority
Coral Stone Filter	<ul style="list-style-type: none"> <li>• Clean, washed coral stone; minimize amount of coral "dust" (very fine particles)</li> <li>• Place on soil/compost layer</li> <li>• Coral stone surface area ≤ 40% of total free storage ponded area</li> </ul>	All flow that passes through coral stone should also pass through soil/compost mix to lower pH and reduce chance of heavy metal leaching
Overflow Structure	<ul style="list-style-type: none"> <li>• Sized for 25-year storm peak intensity and discharge or expected wet season flow</li> <li>• Can be reduced by using off-line design (see Section S2.4)</li> <li>• Structure scaled to application (e.g., yard inlet, commercial structure)</li> </ul>	Off-line designs are encouraged to prevent wet season and intense flows from damaging the filter bed

**Table S2.1. Description of Island Bioretention Design Components  
(see Figures S2.3 through S2.6)**

Material	Specification	Notes
Geotextile	<ul style="list-style-type: none"> <li>• Needle-punched, non-woven geotextile fabric with a flow rate &gt; 110 gal./min./sq. ft. (e.g., Geotex 351 or equivalent)</li> <li>• Place as shown on typical details in Section S2.2</li> </ul>	More impermeable liners may be needed at facility invert for hotspot land uses or in close proximity to drinking water sources; do NOT place impermeable liners between soil/compost and underdrain stone
Underdrains & Cleanouts (only for underdrain designs)	<ul style="list-style-type: none"> <li>• 4 – 6” inch rigid schedule 40 PVC pipe (or equivalent corrugated HDPE for small applications)</li> <li>• 3/8” perforations at 6 inches on center</li> <li>• Perforations only below filter bed</li> <li>• Minimum slope = 0.5%; 1% recommended</li> <li>• Position underdrain pipes ≤ 20’ apart</li> <li>• Clean-outs non-perforated &amp; tied to underdrain with elbow; all clean-outs capped at surface</li> </ul>	Lay the perforated pipe under the length of the bioretention cell, and install non-perforated pipe as needed to connect with the storm drain system. Install T’s and Y’s as needed, depending on the underdrain configuration. Extend cleanout pipes to the surface with vented caps.
Underdrain Stone (only for underdrain designs)	<ul style="list-style-type: none"> <li>• Clean, washed coral stone; minimize amount of coral “dust” (very fine particles)</li> <li>• Place underdrain pipe in top 8” of underdrain stone</li> <li>• Provide ≥ 8” of stone below invert of underdrain pipe to serve as dry season infiltration sump</li> </ul>	Dry season infiltration sump will allow some infiltration, even with relatively poor soils
Plant Materials	<ul style="list-style-type: none"> <li>• Plant mix of herbaceous, shrub, and tree species from plant list (see Section S2.7)</li> </ul>	<p>Establish plant materials as specified in the landscaping plan and the recommended plant list.</p> <p>In general, plant spacing must be sufficient to ensure the plant material achieves 80% cover in the proposed planting areas within a 2-year period.</p> <p>It is recommended to plant trees around the perimeter of Island Bioretention, so that the trees drop vegetative matter on the filter surface to serve as a “self-mulching” mechanism.</p>

## Section S2.3. Feasibility

Bioretention can be applied in most soils or topography, since runoff percolates through an engineered compost and coral stone bed and is infiltrated or returned to the stormwater system. Key considerations with Island Bioretention include the following:

**Available Space.** Designers can assess the feasibility of using bioretention facilities based on a simple relationship between the contributing drainage area (CDA) and the corresponding bioretention surface area. The bioretention surface area will be approximately 3% to 6% of the contributing drainage area, depending on the imperviousness of the CDA and the depth of the filter layers.

**Site Topography.** Bioretention is best applied when the grade of contributing slopes is greater than 1% and less than 5%.

**Available Hydraulic Head.** Bioretention is fundamentally constrained by the invert elevation of the existing conveyance system to which the practice discharges (i.e., the bottom elevation needed to tie the underdrain from the bioretention area into the storm drain system). In general, 4 to 5 feet of elevation above this invert is needed to create the hydraulic head needed to drive stormwater through a proposed bioretention filter bed. Less hydraulic head is needed if the underlying soils are permeable enough to dispense with the underdrain.

**Water Table and Bedrock.** Bioretention should always be separated from the water table and bedrock to ensure that groundwater does not intersect the filter bed. Mixing can lead to possible groundwater contamination or failure of the bioretention facility. A separation distance of 2 feet is recommended between the bottom of the excavated bioretention area and the seasonally high ground water table or bedrock layer.

**Utilities.** Designers should ensure that future tree canopy growth in the bioretention area will not interfere with existing overhead utility lines. Interference with underground utilities should also be avoided, particularly water and sewer lines. Local utility design guidance should be consulted in order to determine the horizontal and vertical clearance required between stormwater infrastructure and other dry and wet utility lines.

**Soils.** Soil conditions do not constrain the use of bioretention, although they determine whether an underdrain is needed. Soils with slow percolation rates in Hydrologic Soil Groups (HSG) C or D usually require an underdrain, whereas HSG A or B soils generally do not. When designing a bioretention practice, designers should verify soil permeability by using the on-site soil investigation methods outlined in the *Manual* and its supplements.

**Contributing Drainage Area.** Bioretention cells work best with smaller contributing drainage areas, where it is easier to achieve flow distribution over the filter bed. Typical drainage area size can range from 0.1 to 2.5 acres and consist of up to 100% impervious cover. The maximum drainage area to a single bioretention area is 5 acres. However, it is strongly recommended that drainage areas be “broken up” through site grading so that each bioretention area receives less than 2.5 acres of drainage (and, therefore, a site may have more than one bioretention area).

**Hotspot Land Uses.** Runoff from hotspot land uses should not be treated with infiltrating bioretention (i.e., constructed *without* an underdrain). For a list of potential stormwater hotspots, consult Section 2.1.1.1 of the *CNMI and Guam Stormwater Management Manual, Volume 1*.

**Floodplains.** Bioretention areas should be constructed outside the limits of the ultimate 100-year floodplain.

**No Irrigation or Baseflow.** The planned bioretention area should not receive baseflow, irrigation water (except during the initial plant establishment period), chlorinated wash-water or other such non-stormwater flows that are not stormwater runoff.

**Setbacks.** To avoid the risk of seepage, do not allow bioretention areas to be hydraulically connected to structure foundations or pavement. At a minimum, bioretention areas should be located a horizontal distance of 100 feet from any water supply well, 50 feet from septic systems, and 5 feet from down-gradient wet utility lines. Dry utility lines such as gas, electric, cable and telephone may cross under bioretention areas if they are double-cased.

**Aesthetics.** Bioretention area locations should be integrated into the site planning process, and aesthetic considerations should be taken into account in their siting and design.

## Section S2.4. Conveyance

There are two options for conveying water into the bioretention area:

1. **On-line** systems convey all runoff into the bioretention area. An overflow structure within the practice manages larger storms (flows greater than the water quality design flow).
2. **Off-line** systems “split” the flow upgradient from the bioretention area so that only design flows associated with the water quality volume enter the facility. This option is preferred for Island Bioretention, especially since wet season flows can easily surpass the treatment capacity of the bioretention area, and these flows can damage the inlet points, filter bed, and other components.

The on-line and off-line options are described below in more detail.

**On-line bioretention:** An overflow structure should always be incorporated into on-line designs to safely convey larger storms through the bioretention area. The following criteria apply to overflow structures:

- The overflow structure should be designed to manage the peak rainfall intensity and flow for the 25-year storm OR expected flows during the wet season. Energy dissipators should be used so that velocities are non-erosive at the outlet point (i.e., to prevent downstream erosion). The overflow structure does not have to be in the filter bed itself, but can be at the edge of the filter bed or on the side slope (see **Figures S2.3 and S2.5**).
- Common overflow systems within bioretention practices consist of an inlet structure, where the top of the structure is placed at the maximum water surface elevation of

the water quality storm event, which is typically designed at 6 to 12 inches above the surface of the filter bed (6 inches is the preferred ponding depth).

- The overflow capture device should be scaled to the application – this may be a landscape or yard grate for small applications or a commercial-type structure for larger systems.
- The filter bed surface should generally be flat so the bioretention area fills up like a bathtub.

***Off-line bioretention (preferred):*** One common approach is to create an alternate flow path at the inflow point into the structure such that when the maximum ponding depth is reached, the incoming flow is diverted past the facility (such as into a drop inlet in the adjacent parking lot). In this case, the higher flows do not pass over the filter bed and through the facility, and additional flow is able to enter as the ponded water filtrates through the soil media.

Another option is to utilize a low-flow diversion or flow splitter at or above the inlet to allow only the design flow associated with the water quality volume to enter the facility, while larger flows bypass the bioretention area altogether. This may be achieved with a weir, curb opening sized for the target flow, or a flow-splitting structure (for instance, in a manhole), in combination with a bypass channel.

## Section S2.5. Pretreatment

**Figures S2.3 through S2.6** illustrate a coral stone level spreader between the parking lot and the filter bed. This spreader is designed to evenly spread flows across the filter bed surface and should be sized for the expected rate of inflow. If the contributing drainage area exceeds 1 acre, then the stone level spreader should be contained in a concrete-lined trench box (instead of the geotextile shown in the figures). The figures also show that the top of the stone spreader is 3" lower than the edge of the pavement. This is designed to prevent clogging and build-up of sand and grit where the parking lot edge meets the stone, thus leading to bypassing of the facility.

Depending on the type and scale of the application, other pretreatment options include:

- ***Pretreatment Cells*** (for larger drainage areas and inflows): Similar to a forebay, this cell is located at piped inlets or curb cuts leading to the bioretention area and consists of an energy dissipator sized for the expected rates of discharge. It has a storage volume equivalent to at least 25% of the water quality volume with a 1.5:1 length-to-width ratio. The cell may be formed by a wooden or stone check dam or an earthen or rock berm. Pretreatment cells do not need underlying soil/compost mix, in contrast to the main bioretention cell. If the pretreatment cell will be on or close to bedrock, or another media that will rapidly infiltrate, the pretreatment cell should be lined so that by-passing of the filter bed does not occur.
- ***Grass Filter Strips or Grass Channels***: Grass filter strips extend a minimum of 10 feet from edge of pavement to the filter bed and have a maximum slope of 20% (5:1). Grass channels designed to convey the water quality volume can also be used at inflow point.
- ***Innovative or Proprietary Structure***: An approved proprietary structure with demonstrated capability of reducing sediment and hydrocarbons may also be used to provide pretreatment.

## Section S2.6. Treatment

See **Table S2.1** for details and notes for each Island Bioretention design component. This section provides further information on practice sizing, soil/compost media, and infiltration testing.

### Sizing of Bioretention

Sizing for Island Bioretention involves calculating the required storage volumes for the criteria that the bioretention area will be designed to manage: recharge volume ( $Re_v$ ), water quality volume ( $WQ_v$ ), channel protection volume ( $Cp_v$ ), and/or overbank flood storage ( $Q_{p-25}$ ). These storage volumes must be allocated to the various layers within the bioretention facility.

In cases where  $Re_v \leq WQ_v$ , size the bioretention area for the  $WQ_v$ . Both criteria will be met.

In cases where  $Re_v > WQ_v$ , either:

- Size the bioretention area for the  $Re_v$ . Both criteria will be met, OR
- Size the bioretention area for the  $WQ_v$ , and implement a downstream infiltration practice for the “leftover” volume ( $Re_v - WQ_v$ ).

In cases where the bioretention will also be designed to manage the  $Cp_v$  and/or  $Q_{p-25}$  (partially or in whole), calculate the greater of the two required storage volumes (likely the  $Q_{p-25}$ ). The storage volume of the bioretention layers can be increased beyond that required for  $Re_v$  and  $WQ_v$  to account for  $Cp_v$  and/or  $Q_{p-25}$  storage requirements. However, at least 75% of the additional storage volume must be provided as free storage above the filter bed (the remaining 25% can be allocated to the soil/compost and/or underdrain layers). Maximizing the surface area of the grass filter strip area can help with this type of design.

The storage and sizing equations for Island Bioretention are as follows:

$$Re_v \text{ \& } WQ_v \text{ (greater of the two)} \leq 0.75 \times (V_{fs} + V_s + V_{cs} + V_{is})$$

Where:

$V_{fs}$  = Storage volume of free storage = free storage x 1.0

$V_s$  = Storage volume of soil/compost = volume of soil/compost x 0.25

$V_{cs}$  = Storage volume of coral stone layer = volume of coral stone layer x 0.40

$V_{is}$  = Storage volume of infiltration sump layer (below underdrain) = volume of infiltration sump x 0.40

$$Cp_v \text{ \& } Q_{p-25} \text{ (greater of the two)} \leq (Re_v \text{ and } WQ_v \text{ storage}) + (\text{additional storage provided in } V_{fs} + V_s + V_{cs} + V_{is})$$

If approved by the plan-approving authority, credit for the  $Cp_v$  /  $Q_{p-25}$  can also be obtained by reducing the curve number (CN) of the contributing drainage area to a bioretention area.

*Total surface area of bioretention = free storage ponding area + grass filter strip area + soil/compost area + coral stone area*

*Total surface area  $\geq$  3% of the contributing drainage area*

*Coral stone area  $\leq$  40% of total surface area*

*Grass filter strip area  $\leq$  25% of total surface area*

### **Soil/Compost Media**

It will be necessary to find a suitable soil/compost mix for Island Bioretention. This mix will likely come from a topsoil vendor or other local source. Guidelines for creating and testing the soil/compost mix are detailed in the Soil/Compost Mix specification as part of this supplement.

### **Infiltration Rate Testing for Infiltration Designs**

For designs that do NOT include an underdrain, it will be necessary to conduct infiltration testing to determine infiltration suitability. If underlying soils are not suitable for infiltration, the underdrain design should be used. Guidelines for conducting the infiltration test (field test to determine hydraulic conductivity) are included in this supplement.

## **Section S2.7. Landscaping/Planting Plan**

The following landscaping/planting plan guidance is provided for Island Bioretention:

- Landscaping is critical to the performance and function of bioretention areas. Therefore, a landscaping plan must be provided for bioretention areas (see **Table S2.2** for recommended plants).
- Planting recommendations for bioretention facilities are as follows:
  - Native plant species should be specified over non-native species when possible.
  - Vegetation should be selected based on a specified zone of hydric tolerance, with “wetter” species in the bottom and “drier” species around the edges of the filter bed.
  - The emphasis of the planting plan should be to have vegetation cover the surface area of the filter bed in a short amount of time. Most of the species should be herbaceous, with relatively small trees or shrubs around the perimeter.
  - Woody vegetation should not be specified at inflow locations.
  - Trees should not be planted directly on top of underdrains and may best be located along the perimeter of the practice.



**Table S2.2. Recommended Plant Species for Island Bioretention (Pacific)\***

Plant	Notes
<b>Dwarf Brazilian banana</b> 'Santa Catarina Prata' ( <i>Musa spp.</i> )	Dwarf bananas like this variety should be used since short banana plants can be grown at closer spacing with less lodging (falling over) than tall varieties. Closer spacing is needed to get a dense concentration of stems within the bioretention area to absorb nutrients and transpire water. These plants would not tolerate permanent flooding, so it is important that bioretention areas fully drain between rainfall events.
<b>Orange Day Lily</b> ( <i>Hemerocallis aurantiaca</i> ; also known as <i>Hemerocallis fulva</i> )	This species has been tested by NRCS Plant Materials Center. As above, it would not tolerate permanent flooding.
<b>Kang kung</b> ( <i>Ipomoea aquatica</i> )	Also known as "Swamp Morning-Glory," it is one of the three major dark-green leafy vegetables grown in this part of the world. Unlike the other two (Mustard Greens and Chinese Cabbage), its hollow stems permit it to float on the water surface, and thus, it has advantages in submerged conditions. It does best when its roots are anchored in a couple inches of soil.
<b>Vetivergrass 'Sunshine'</b> ( <i>Chrysopogon zizanioides</i> )	It does not produce seeds, so will not spread. It makes a very thick hedge that does better than any other grass to slow flowing water.
<b>Lemongrass</b> ( <i>Cymbopogon citratus</i> )	Similar to Vetivergrass, but it does not produce as good of a barrier. It is popular since it has a second use in cooking (however, it is not recommended to eat plants harvested from bioretention areas).
<b>Dwarf Napiergrass 'Mott'</b> ( <i>Pennisetum purpureum</i> )	The tall habit of Napiergrass is one of the main cut-and-carry forages in Saipan ('Boksow'). The dwarf variety is better for vegetative barriers since it will not lodge by growing tall, and makes a thicker barrier. The tall varieties (12 feet AKA Elephantgrass) should NOT be used, since they are listed as invasive.
<b>Pink Water Lily</b> ( <i>Nymphaea</i> )	Could do OK in wetter parts of bioretention (bottom, middle of filter bed), although it may be too dry during dry season.
* Designers may choose other suitable plants in consultation with landscape architects, horticulturalists, other design professionals. Other plants that were noted during the 2009 LID workshop on Guam include Hibiscus, Coconut Palms, and Ifit trees. Designers should avoid plants with large root systems.	

## Section S2.8. Construction Sequence

The section provides a typical construction sequence. However, the actual sequence will depend on site conditions and the location of the bioretention area in relation to other areas of the site that are under construction. ***In all cases, it is important to prevent construction sediment from entering the bioretention area.***

1. Bioretention areas should remain outside the limit of disturbance during construction to prevent soil compaction by heavy equipment.
2. Construction of the bioretention area may only begin after the entire contributing drainage area has been stabilized with vegetation. It may be necessary to block certain curb or other inlets while the bioretention area is being constructed. **PREMATURE INSTALLATION OF BIORETENTION DURING CONSTRUCTION IS THE #1 CAUSE OF PRACTICE FAILURE (see **Figure S2.7**).** The proposed site should be checked for existing utilities prior to any excavation. It may be necessary to install temporary erosion and sediment control measures (e.g., silt fence) around the perimeter of bioretention construction areas to keep sediment from side slopes and drainage area out of the filter bed area.
3. Excavators or backhoes working adjacent to or around the perimeter of the proposed bioretention area should excavate to the appropriate design depth. Equipment tracks and wheels should stay out of the filter bed area. It is recommended to “rip” or loosen the underlying native soil (with the excavator bucket or a tiller) to promote better infiltration.
4. Install the underdrain system if included in the design (including clean-outs and overflow structures). Cover the underdrain layer with needle-punched, non-woven geotextile, allowing enough material to extend under the stone level spreaders adjacent to the pavement, as applicable.
5. Place the approved soil/compost mix, applying in 12” inch lifts until the desired top elevation is achieved. It may be necessary to wait a few days to check for settlement, and add additional media as needed.
6. Make sure the coral stone is washed and clean (minimize coral dust). Place the coral stone layer so that the top of the coral stone is even with or just below the elevation of the soil/compost layer.
7. Install the stone level spreaders or other approved pretreatment measures. Make sure that the top of the stone level spreader is approximately 3” below the elevation of the adjacent pavement.
8. Install the plant materials as per approved plans, and irrigate accordingly to ensure survival.
9. Conduct final construction inspection, checking inlet, pretreatment cell or stone spreader, bioretention cell/filter bed, and outlet elevations.



**Figure S2.7. Construction sediment can easily damage bioretention filter bed (left). Block inlets during construction (middle) and/or install temporary silt fence around perimeter of bioretention during construction (right).**

## Section S2.9. Maintenance

**Table S2.3** provides recommended maintenance activities and frequencies for bioretention.

<b>Table S2.3. Recommended Maintenance Activities for Bioretention Areas</b>	
<b>Activity</b>	<b>Schedule</b>
<ul style="list-style-type: none"> <li>• Pruning and weeding to maintain appearance.</li> <li>• Remove overgrowth of plant materials.</li> <li>• Remove plant debris that seems to be clogging the filter bed.</li> <li>• Remove trash and debris.</li> <li>• Water plants during dry season, if necessary.</li> <li>• Check and rectify standing water, insect habitat.</li> </ul>	As needed
<ul style="list-style-type: none"> <li>• Inspect inflow points for clogging. Remove build-up of sediment and debris.</li> <li>• Inspect overflow structure and remove sediment and debris.</li> <li>• Inspect plant materials for survival and replace any dead or severely diseased vegetation.</li> </ul>	Semi-annually, at beginning of wet and dry seasons
<ul style="list-style-type: none"> <li>• Inspect and remove any sediment and debris build-up in pretreatment areas.</li> <li>• Inspect inflow points and filter bed for build-up of sediment and debris.</li> </ul>	Annually, after wet season
<ul style="list-style-type: none"> <li>• Remove the top layer (approximately 3") of coral stone if necessary and replace with clean stone.</li> <li>• Remove the top layer of soil/compost mix if necessary and replace with clean material.</li> <li>• Replace coral stone in stone level spreaders if needed.</li> <li>• The planting soils should be tested for pH to establish acidic levels. If the pH is above 7.3, then iron sulfate plus sulfur can be added to reduce the pH.</li> </ul>	2 to 3 years
<ul style="list-style-type: none"> <li>• Replace or rehabilitate filter bed materials if permanently clogged.</li> <li>• Clean out underdrains if clogged with roots or debris.</li> </ul>	Infrequently, as needed

## Island Bioretention



Description: Shallow stormwater basin or landscaped area that utilizes engineered soil/compost mix, coral stone, and vegetation to capture and treat runoff. The practice is often located in parking lot islands and can also be used to treat residential areas.

Design Practices: Island Bioretention (Supplement #2)

### KEY CONSIDERATIONS

#### CONVEYANCE

- Conveyance to the system is typically overland flow delivered to the surface of the system, typically through curb cuts or over a concrete lip.
- Provide overflow to the storm sewer system for flows larger than the design flow.

#### PRETREATMENT

- Pretreatment consists of a stone level spreader, pretreatment cell, or equivalent practice described in **Section S2.5**.

#### TREATMENT

- Treatment area should generally have a soil/compost layer, coral stone layer, and a 6 - 12" ponding layer.
- Size the treatment area using equations provided in **Section S2.6**.

#### LANDSCAPING

- Detailed landscaping plan required.
- Recommended plant list in **Section S2.7**.

#### MAINTENANCE REQUIREMENTS:

- See maintenance activities and frequencies in **Section S2.9**.

### STORMWATER MANAGEMENT SUITABILITY

- Water Quality**
- Recharge**
- Channel Protection (partial)**
- Overbank Flood (partial)**

Accepts Hotspot Runoff: *Do not use infiltration designs. Liner may be needed for certain hotspots.*

### IMPLEMENTATION CONSIDERATIONS

- Capital Cost**
- Maintenance Burden**

Residential/Subdivision Use: *Yes*  
High Density/Ultra-Urban: *Yes*

Drainage Area: *5 acres max. Less than 2.5 acres recommended.*

Soils: *Soil/Compost Mix created as per specification in the Manual supplement.*

Other Considerations:

**Use of native plants is recommended**

**Key: L=Low M=Moderate H=High**

**POLLUTANT REMOVAL**

- |   |
|---|
| G |
|---|

 Phosphorus
- |   |
|---|
| G |
|---|

 Nitrogen
- |   |
|---|
| G |
|---|

 Metals - Cadmium, Copper, Lead, and Zinc removal
- |   |
|---|
| F |
|---|

 Pathogens - Coliform, *Streptococci*, *E. coli* removal

**Key: G=Good F=Fair P=Poor**

## Island BMP Specification #3: Permeable Parking & Walkways



**Island BMP Specification #3: Permeable Parking and Walkways**  
*Supplemental Design Criteria for the CNMI & Guam Stormwater Management Manual, 2006. To be added as supplement to Volume 1, Chapter 3*

**Section S3.1. Introduction**

Permeable parking and walkways are alternatives to the conventionally paved surfaces that allow stormwater runoff to filter through voids in the pavement surface into an underlying stone layer, where it is temporarily stored and/or infiltrated. This specification focuses on the use of permeable interlocking concrete pavers (PICP) and concrete grid pavers (CGP). However, a variety of other permeable pavement surfaces are available; including pervious concrete, porous asphalt, and plastic grid pavers. While the specific design may vary, all permeable pavements have a similar structure, consisting of a surface pavement layer, a bedding layer, an underlying stone layer, a filter layer and a geotextile installed on the bottom (See **Figures S3.2** through **S3.5** below).

The thickness of the underlying stone layer is determined by both a structural and hydrologic design analysis. This layer serves to retain stormwater and also supports the design traffic loads for the pavement. There are two basic design adaptations for Permeable Parking and Walkways:

1. Infiltration Design (no underdrain): If infiltration rates in the native soils permit, permeable pavement can be designed *without* an underdrain, to enable full infiltration of runoff. Soil testing should be performed at the site to ensure suitable infiltration rates, relatively low water tables, and a low risk of groundwater contamination (e.g., not located at a stormwater hotspot). See **Figures S3.2** and **S3.4** for typical details of the infiltration design.

2. Filter Design (with underdrain): For sites where native soils do not percolate as readily, some or all of the filtered runoff can be collected in an underdrain and returned to the storm drain system. The use of underdrains is recommended when there is a reasonable potential for infiltration rates to decrease over time, when underlying soils have an infiltration rate of less than 1/2-inch per hour, or when soils must be compacted to achieve a desired Proctor density (see structural design in section S3.6). These designs still incorporate some level of infiltration, especially during the dry season, by providing a coral stone “infiltration sump” and filter layer below the underdrain pipe. See **Figures S3.5** and **S3.6** for typical details of the filter design.

This type of system is recommended for CNMI and Guam to reduce the volume of stormwater generated and encourage groundwater recharge. These practices may also provide some water quality benefit as stormwater is filtered through a soil/compost mix layer.

Treatment Suitability: Permeable parking and walkway designs are flexible and can be designed to manage the recharge volume ( $Re_v$ ) water quality volume ( $WQ_v$ ), channel protection volume ( $Cp_v$ ), and/or overbank flood storage ( $Q_{p-25}$ ). However, customary designs address only the  $Re_v$  and  $WQ_v$ , with other downgradient practices managing the

larger volumes associated with the  $Cp_v$  and  $Q_{p-25}$ . Larger storm control can be built into the design by increasing the depth of the coral stone layer.

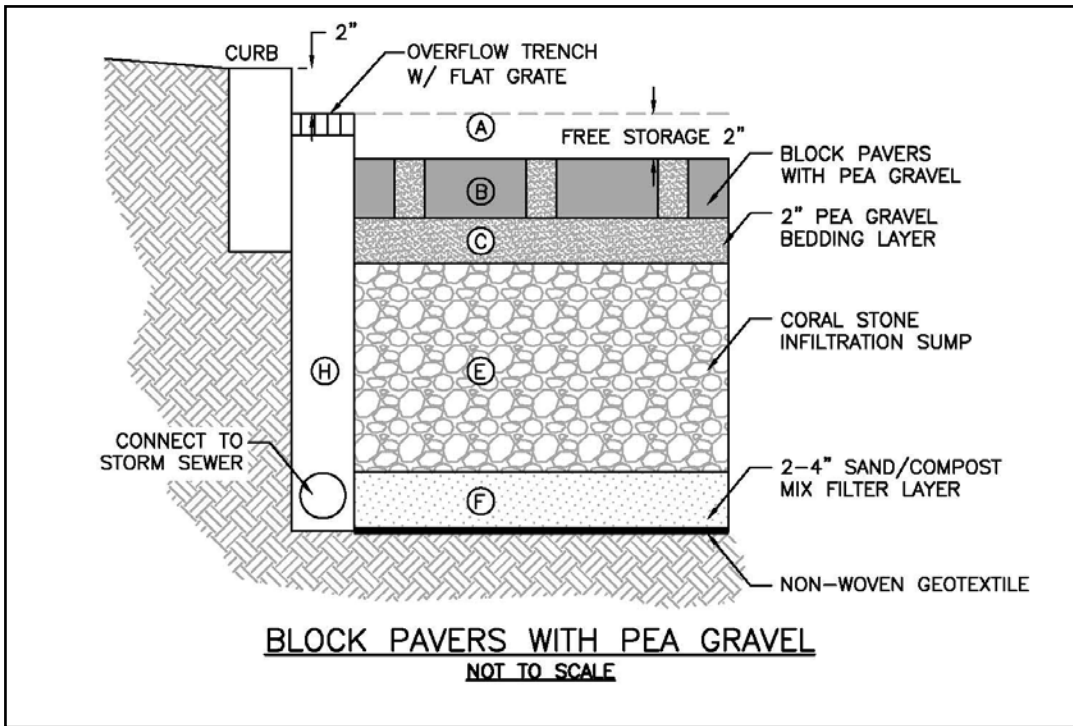


**Figure S3.1. Examples of permeable pavement on Saipan and Puerto Rico**

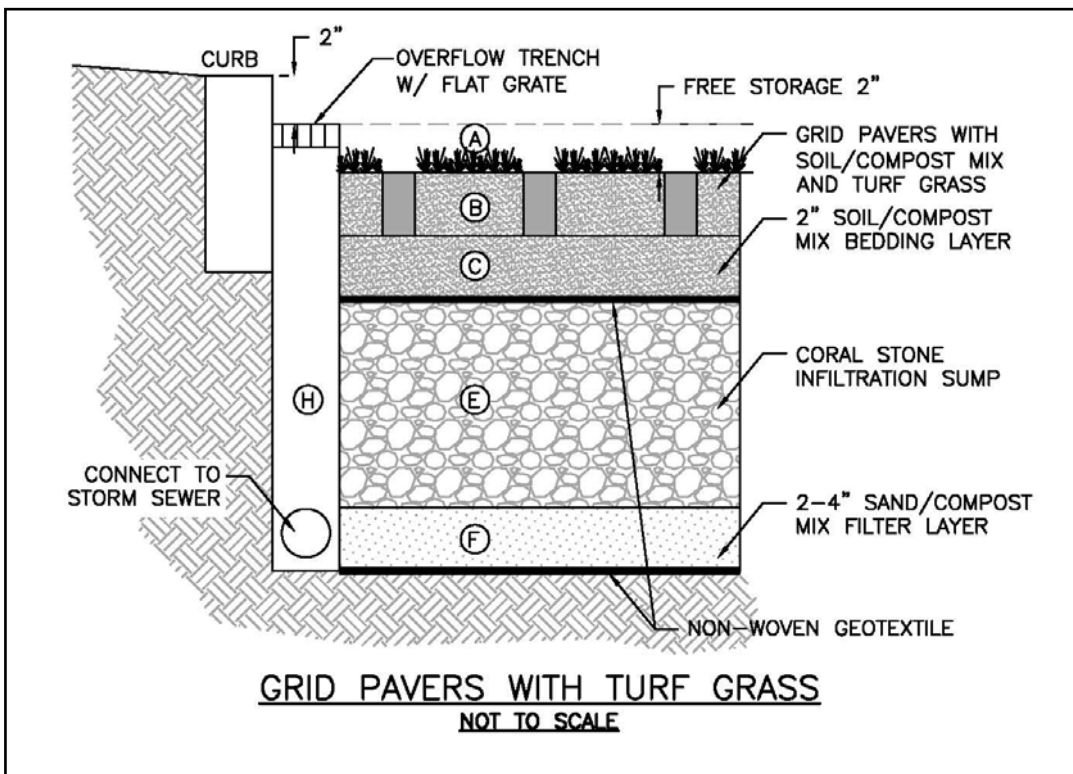
### Section S3.2. Typical Details

Typical details are shown in **Figures S3.2** through **S3.5** for PICP and CGP infiltration and filtration designs. **Table S3.1** provides details and notes for each of the permeable parking design components shown in the typical details.

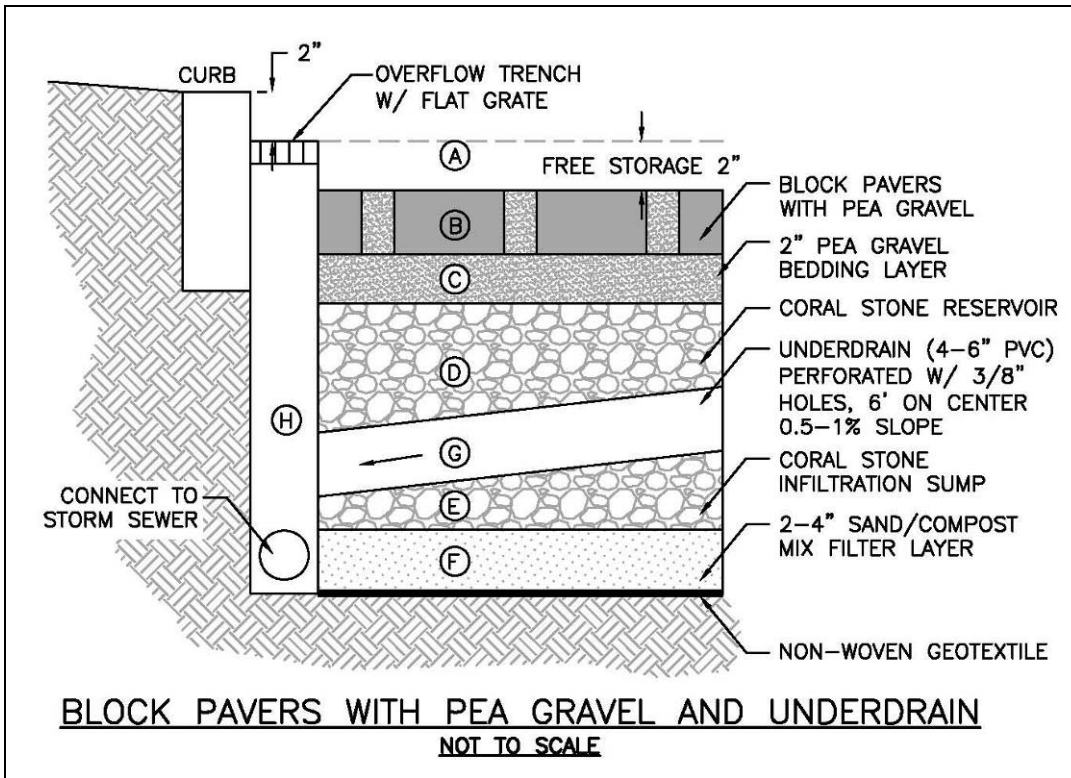




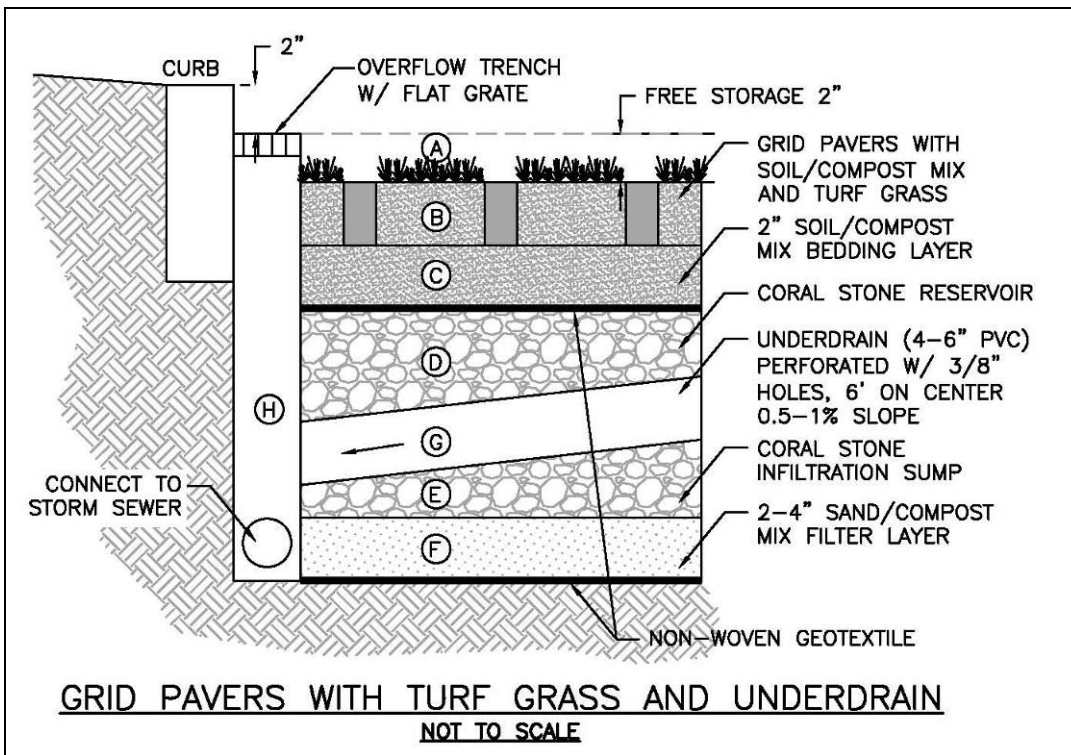
**Figure S3.2. Cross-sections for Permeable Interlocking Concrete Paver (PICP) infiltration design version (no underdrain).**



**Figure S3.3. Cross-sections for Concrete Grid Paver (CGP) infiltration design version (no underdrain).**



**Figure S3.4. Cross section of PICP filter design version (includes underdrain).**



**Figure S3.5. Cross section of CGP filter design version (includes underdrain).**

<b>Table S3.1. Description of Permeable Parking and Walkway Design Components</b>		
<b>Material</b>	<b>Specification</b>	<b>Notes</b>
<b>Free Storage (A*)</b>	<ul style="list-style-type: none"> <li>• 2" above pavement surface</li> </ul>	Control ponding level with overflow structure, or by-pass higher flows to drop inlet in parking lot.
<b>Pavement Surface (B)</b>	PICP: <ul style="list-style-type: none"> <li>• Surface open area: 5% to 15%.</li> <li>• Thickness: 3.125 inches for vehicles.</li> <li>• Compressive strength: 55 Mpa.</li> <li>• Open void fill media: pea gravel</li> </ul>	Should conform to ASTM C936 specifications.
	CGP <ul style="list-style-type: none"> <li>• Open void content: 20% to 50%.</li> <li>• Thickness: 3.5 inches.</li> <li>• Compressive strength: 35 Mpa.</li> <li>• Open void fill media: pea gravel, topsoil and grass, or coarse sand.</li> </ul>	Should conform to ASTM C 1319 specifications.
<b>Bedding Layer (C)</b>	PICP: 2 " depth of pea gravel	
	CGP: 2" soil/compost mix	Follow guidance in Soil Compost Media specification. Other compost media or sand mixtures may be substituted if tested and approved by the plan-approving authority.
<b>Coral Stone Infiltration Sump Layer (E)</b>	<ul style="list-style-type: none"> <li>• Clean, washed coral stone; minimize amount of coral "dust" (very fine particles)</li> <li>• Bottom of this layer should be flat</li> <li>• Place on sand/compost filter layer</li> </ul>	<p>For infiltration designs (without underdrains), this layer should be sized for both the storm event to be treated and the structural requirements of the expected traffic loading.</p> <p>For filter designs (with underdrains), the additive coral stone infiltration sump layer (E) and underdrain coral stone reservoir (D) should be sized for both the storm event to be treated and the structural requirements of the expected traffic loading.</p> <p>All flow that passes through coral stone should also pass through soil/compost mix to lower pH and reduce chance of heavy metal leaching.</p>

<b>Table S3.1. Description of Permeable Parking and Walkway Design Components</b>		
<b>Material</b>	<b>Specification</b>	<b>Notes</b>
<b>Underdrains &amp; Cleanouts (only for underdrain designs) (G)</b>	<ul style="list-style-type: none"> <li>• 4 – 6” inch rigid schedule 40 PVC pipe (or equivalent corrugated HDPE for small applications)</li> <li>• 3/8” perforations at 6 inches on center</li> <li>• Perforations only below filter bed</li> <li>• Minimum slope = 0.5%; 1% recommended</li> <li>• Position underdrain pipes ≤ 20’ apart</li> <li>• Clean-outs non-perforated &amp; tied to underdrain with elbow; all clean-outs capped at surface</li> </ul>	Lay the perforated pipe under the length of the pavement cell, and install non-perforated pipe as needed to connect with the storm drain system. Install T’s and Y’s as needed, depending on the underdrain configuration. Extend cleanout pipes to the surface with vented caps.
<b>Underdrain Coral Stone Layer (only for underdrain designs) (D)</b>	<ul style="list-style-type: none"> <li>• Clean, washed coral stone; minimize amount of coral “dust” (very fine particles)</li> <li>• Place underdrain pipe in top 8” of underdrain stone</li> <li>• Provide ≥ 8” of stone below underdrain pipe to serve as dry season infiltration sump</li> </ul>	<p>The coral stone layer underneath the underdrain (E) will act as an infiltration sump and allow some infiltration, even with relatively poor soils.</p> <p>The additive coral stone infiltration sump layer (E) and underdrain coral stone layer (D) should be sized for both the storm event to be treated and the structural requirements of the expected traffic loading.</p>
<b>Sand/Compost Filter Layer (F)</b>	<ul style="list-style-type: none"> <li>• Where possible, sand should be used for the filter layer. If sand materials are limited, a sand/compost layer can be used. Follow guidance in Soil Compost Media specification for any compost material.</li> <li>• Place underneath coral stone layer so that all flow passes through this layer.</li> </ul>	Other compost media or sand mixtures may be substituted if tested and approved by the plan-approving authority.
<b>Geotextile</b>	<ul style="list-style-type: none"> <li>• Needle-punched, non-woven geotextile fabric with a flow rate &gt; 110 gal./min./sq. ft. (e.g., Geotex 351 or equivalent)</li> <li>• Place as shown on typical details in Section S3.2)</li> </ul>	More impermeable liners may be needed at facility invert for hotspot land uses or in close proximity to drinking water sources; do NOT place impermeable liners between soil/compost and underdrain stone.
<b>Impermeable Liner</b>	NOTE: THIS IS ONLY RECOMMENDED FOR DESIGNS IN CLOSE PROXIMITY TO WATER SUPPLY SOURCES, FILL SLOPES, and OTHER HOTSPOT AREAS. Using this layer effectively eliminates the potential to meet the Rev requirement (see Section S3.6). Use a thirty mil (minimum) PVC Geomembrane liner covered by 8 to 12 oz./sq. yd. non-woven geotextile.	

<b>Table S3.1. Description of Permeable Parking and Walkway Design Components</b>		
<b>Material</b>	<b>Specification</b>	<b>Notes</b>
<b>Overflow Structure (H)</b>	<ul style="list-style-type: none"> <li>• Sized for 10-year storm peak intensity and discharge or expected wet season flow</li> <li>• Can be reduced by using design modifications (see Section S3.4)</li> <li>• Structure scaled to application (e.g., yard inlet, commercial structure)</li> </ul>	
<b>Observation Well</b>	Use a perforated 4- to 6-inch vertical PVC pipe (AASHTO M 252) with a lockable cap, installed flush with the surface.	The observation well is used to observe the rate of drawdown within the coral stone layer following a storm event and to facilitate periodic inspection and maintenance.

\* Letters correspond to labels in **Figures S3.2 through S3.5.**

### Section S3.3. Feasibility

The following considerations and design guidance are important when planning and implementing permeable parking and walkway systems.

**Available Space.** A prime advantage of permeable pavement is that it does not normally require additional space at a new development or redevelopment site, which can be important for tight sites or areas where land prices are high.

**Soils.** Soil conditions do not constrain the use of permeable pavement, although they do determine whether an underdrain is needed. Impermeable soils in Hydrologic Soil Groups (HSG) C or D usually require an underdrain, whereas HSG A and B soils often do not. In addition, permeable pavement should never be situated above fill soils unless designed with an impermeable liner and underdrain. When designing permeable pavement, designers should verify soil permeability by using the on-site soil investigation methods outlined in the *Manual* and its supplements.

**External Drainage Area.** Any external drainage area contributing runoff to permeable pavement should generally not exceed twice the surface area of the permeable pavement, and it should be as close to 100% impervious as possible. Some field experience has shown that an upgradient drainage area (even if it is impervious) can contribute particulates to the permeable pavement and lead to clogging (Hirschman, et al., 2009). Therefore, careful sediment source control and/or a pre-treatment strip or sump (e.g., stone or gravel) should be used to control sediment run-on to the permeable pavement section.

**Pavement Slope.** Steep slopes can reduce the stormwater storage capability of permeable pavement and may cause shifting of the pavement surface and base materials. The pavement surface slope should be less than 0.5%. The bottom slope of a permeable pavement installation should be as flat as possible (i.e., 0% longitudinal slope) to enable even distribution and infiltration of stormwater. Designers should consider using a terraced design for permeable pavement in sloped areas, especially when the local slope is several percent or greater.

**Minimum Hydraulic Head.** The elevation difference needed for permeable pavement to function properly is generally nominal, although 2 to 4 feet of head may be needed to drive flows through underdrains. Flat terrain may affect proper drainage, so underdrains should have a minimum 0.5% slope.

**Water Table and Bedrock.** Permeable pavement should always be separated from the water table and bedrock to ensure that groundwater does not intersect the underlying coral stone or filter layers. Mixing can lead to possible groundwater contamination or failure of the permeable pavement facility. A separation distance of 2 feet is recommended between the bottom of the excavated permeable pavement area (i.e., the bottom invert of the filter layer) and the seasonally high ground water table or bedrock layer.

**Setbacks.** Permeable pavement should not be hydraulically connected to structure foundations, in order to avoid harmful seepage. At a minimum, permeable parking and walkways should be located a minimum horizontal distance of 100 feet from any water supply well, 50 feet from septic systems, and at least 5 feet down-gradient from dry or wet utility lines such as gas, electric, cable and telephone (unless these are double-cased).

**Informed Owner.** The property owner should clearly understand the unique maintenance responsibilities inherent with permeable pavement, particularly for parking lot applications. The owner should be capable of performing routine and long-term actions (e.g., vacuum sweeping) to maintain the pavement's hydrologic functions, and avoid future practices (e.g., seal coating or repaving) that diminish or eliminate them.

**High Loading Situations and Hotspot Land Uses.** Permeable pavement is not intended to treat sites with high sediment or trash/debris loads, since such loads will cause the practice to clog and fail. Further, runoff from hotspot land uses should not be treated with permeable parking or walkways. For a list of potential stormwater hotspots, please consult Section 2.1.1.1 of the *CNMI and Guam Stormwater Management Manual, Volume 1*.

## Section S3.4. Conveyance

Permeable parking and walkway designs should include methods to convey larger storms (e.g., 2-yr, 10-yr) to the storm drain system. The following is a list of methods that can be used to accomplish this:

- Set the storm drain inlets 2" above the elevation of the permeable pavement surface to effectively convey excess stormwater runoff past the system.
- Route excess flows to another detention or conveyance system that is designed for the management of extreme event flows.
- Create underground detention within the coral stone layer of the permeable pavement system. Storage may be augmented by corrugated metal pipes, plastic or concrete arch structures, etc.

- Increase the thickness of the top of the coral stone layer by as much as 6 inches (i.e., create freeboard). The design computations used to size the coral stone layer assume that no freeboard is present. As this will make the system deeper, make sure to maintain adequate separations to water table and bedrock (see **Table S2.1**).
- Place a perforated pipe horizontally near the top of the coral stone layer to pass excess flows after water has filled the base. The placement and/or design should be such that the incoming runoff is not captured (e.g., placing the perforations on the underside only).
- In infiltration designs, underdrains can also be used to manage extreme storm events to keep detained stormwater from backing up into the permeable pavement.

### Section S3.5. Pretreatment

Pretreatment for most permeable pavement applications is not necessary, since the surface acts as pretreatment to the coral stone layer below. Additional pretreatment may be appropriate if the pavement receives run-on from an adjacent pervious or impervious area. For example, a gravel filter strip can be used to trap coarse sediment particles before they reach the permeable pavement surface, in order to prevent premature clogging.

Regular street sweeping of permeable parking areas is in essence a pretreatment measure to help prevent pavement surface clogging. More information on pavement street sweeping is found in section S3.9 below.

### Section S3.6. Treatment

This section provides further information on practice sizing, internal geometry, soil/compost media, and infiltration testing.

**Structural Design.** If permeable pavement will be used in a parking lot or other setting that involves vehicles, the pavement surface must be able to support the maximum anticipated traffic load. The structural design process will vary according to the type of pavement selected, and the manufacturer's specific recommendations should be consulted. The thickness of the permeable pavement and coral stone layer must be sized to support structural loads and to temporarily store the design storm volume (e.g., the water quality, channel protection, and/or flood control volumes). On most new development and redevelopment sites, the structural support requirements will dictate the depth of the underlying coral stone layer.

The structural design of permeable pavements involves consideration of four main site elements:

- Total traffic;
- In-situ soil strength;
- Environmental elements; and
- Bedding and coral stone layer design.

The resulting structural requirements may include, but are not limited to, the thickness of the pavement, filter, and coral stone layer. Designers should note that if the underlying soils have a low California Bearing Ratio (CBR) (less than 4%), they may need to be compacted to at least 95% of the Standard Proctor Density, which generally rules out their use for infiltration.

**Designers should consult a structural or roadway design engineer to determine the structural design requirements for all permeable pavement systems that are expected to receive vehicle traffic and loading,**

**Hydraulic Design.** Hydraulic sizing for permeable pavement involves calculating the required storage volumes for the criteria that the permeable pavement area will be designed to manage: recharge volume ( $Re_v$ ), water quality volume ( $WQ_v$ ), channel protection volume ( $Cp_v$ ), and/or overbank flood storage ( $Q_{p-25}$ ). These storage volumes must be allocated to the various layers within the permeable pavement facility.

In cases where  $Re_v \leq WQ_v$ , size the permeable pavement area for the  $WQ_v$ . Both criteria will be met.

In cases where  $Re_v > WQ_v$ , either:

- Size the permeable pavement area for the  $Re_v$ . Both criteria will be met, OR
- Size the permeable pavement area for the  $WQ_v$ , and implement a downstream infiltration practice for the “leftover” volume ( $Re_v - WQ_v$ ).

In cases where permeable pavement will also be designed to manage the  $Cp_v$  and/or  $Q_{p-25}$  (partially or in whole), calculate the greater of the two required storage volumes. The storage volume of the permeable pavement layers can be increased beyond that required for  $Re_v$  and  $WQ_v$  to account for  $Cp_v$  and/or  $Q_{p-25}$  storage requirements.

The storage and sizing equations for permeable pavement are as follows (See **Figures S3.2** through **S3.5** for graphical depictions of the various layers and **Table S3.1** for details and notes for each permeable pavement design component):

**Designs lacking underdrains:**

$$Re_v \text{ \& } WQ_v \text{ (greater of the two)} \leq V_A + V_B + V_C + V_E + V_F$$

$$Cp_v \text{ \& } Q_{p-25} \text{ (partial)} = (Re_v \text{ and } WQ_v \text{ storage}) + (\text{additional storage provided in } V_A + V_B + V_C + V_E + V_F)$$

**Designs with underdrains:**

$$Re_v \text{ \& } WQ_v \text{ (greater of the two)} \leq V_A + V_B + V_C + V_D + V_E + V_F$$

$$\text{with at least 25\% of } RE_v \text{ storage contained in } V_E + V_F$$

$$Cp_v \text{ \& } Q_{p-25} \text{ (partial)} = (Re_v \text{ and } WQ_v \text{ storage}) + (\text{additional storage provided in } V_A + V_B + V_C + V_D + V_E + V_F)$$



Where:

$V_A$  = Storage volume of free storage = free storage volume (A) x 1.0

$V_B$  = Storage volume of surface storage layer = surface layer volume (B) X surface open void space;

(PICP open void space = 0.1, CGP open void space = 0.4)

$V_C$  = Storage volume of soil/compost bedding layer = soil/compost bedding volume x 0.25

$V_D$  = Storage volume of coral stone underdrain layer (above underdrain) = coral stone underdrain layer volume (D) x 0.40

$V_E$  = Storage volume of coral stone infiltration sump layer (below underdrain) = volume of coral stone layer (E) x 0.40

$V_F$  = Storage volume of soil/compost filter layer = volume of soil/compost filter (F) x 0.25

$V_G$  = Underdrain, sized for expected wet season flows

$V_H$  = Overflow, sized for wet season, such that peak managed by (G) + (H)

If approved by the plan-approving authority, credit for the  $C_p$ / $Q_{p-25}$  can also be obtained by reducing the curve number (CN) of the contributing drainage area to a permeable pavement area and the surface area of the permeable pavement itself.

#### Internal Geometry and Drawdowns

- **Elevated Underdrain.** To promote greater runoff reduction for permeable pavement located on marginal soils, an elevated underdrain should be installed with a stone jacket that creates a deep storage layer greater or equal to 8 inches *below* the underdrain invert.
- **Conservative Infiltration Rates.** Designers should always decrease the measured infiltration rate by a factor of 2 during design, to approximate long-term infiltration rates.

#### Soil/Compost Media

It will be necessary to find a suitable soil/compost mix for the permeable pavement filter layer. This mix will likely come from a topsoil vendor or other local source. Guidelines for creating and testing the soil/compost mix are detailed in the Soil/Compost Mix specification as part of this supplement.

#### Infiltration Rate Testing for Infiltration Designs

For designs that do NOT include an underdrain, it will be necessary to conduct infiltration testing to determine infiltration suitability. If underlying soils are not suitable for infiltration, the underdrain design should be used. Guidelines for conducting the infiltration test (field test to determine hydraulic conductivity) are included in this supplement.

## Section S3.7. Landscaping

For CGP applications, a dense, healthy turf cover should be established in the pavement surface voids before traffic is allowed onto the practice.

Most local communities now require from 5% to 10% (or more) of the area of parking lots to be in landscaping. Large-scale permeable pavement applications should be carefully planned to integrate this landscaping in a manner that maximizes runoff treatment and minimizes the risk that sediment, mulch, grass clippings, leaves, nuts, and fruits will inadvertently clog the paving surface.

## Section S3.8. Construction Sequence

Experience has shown that proper installation is absolutely critical to the effective operation of a permeable pavement system.

### **3.8.1 Necessary Erosion & Sediment Controls**

- All permeable pavement areas should be fully protected from sediment intrusion by silt fence or other sediment barriers, particularly if they are intended to infiltrate runoff.
- Permeable pavement areas should remain outside the limit of disturbance during construction to prevent soil compaction by heavy equipment. Permeable pavement areas should be clearly marked on all construction documents and grading plans. To prevent soil compaction, heavy vehicular and foot traffic should be kept out of permeable pavement areas during and immediately after construction.
- During construction, care should be taken to avoid tracking sediments onto any permeable pavement surface to avoid clogging.
- Any area of the site intended ultimately to be a permeable pavement area should generally not be used as the site of a temporary sediment basin.

### **3.8.2. Permeable Pavement Construction Sequence**

The following is a typical construction sequence to properly install PICP and CGP for parking or walkways. This sequence may need to be modified if other types of permeable pavement (i.e., porous asphalt and pervious concrete) designs are employed.

**Step 1.** Construction of the permeable pavement shall only begin after the entire contributing drainage area has been stabilized. The proposed site should be checked for existing utilities prior to any excavation. Do not install the system during rainfall.

**Step 2.** As noted above, temporary erosion and sediment (E&S) controls are needed during installation to divert stormwater away from the permeable pavement area until it is completed. Special protection measures such as erosion control fabrics may be needed to protect vulnerable side slopes from erosion during the excavation process. The proposed permeable pavement area must be kept free from sediment during the entire

construction process. Construction materials that are contaminated by sediments must be removed and replaced with clean materials.

**Step 3.** Where possible, excavators or backhoes should work outside the permeable pavement footprint area to excavate the underlying layers to their appropriate design depth and dimensions. This action will help to avoid compaction of underlying soils. Contractors can utilize a cell construction approach, whereby the proposed permeable pavement area is split into 500 to 1000 sq. ft. temporary cells with a 10- to 15-foot earth bridge in between, so that cells can be excavated from the side. Excavated material should be placed away from the open excavation so as to not jeopardize the stability of the side walls.

**Step 4.** Any native soils along the bottom and sides of the permeable pavement system should be scarified or tilled to a depth of 3 to 4 inches prior to the placement of the geotextile and filter layer. In large scale parking applications with weak underlying soils, the soil subgrade may need to be compacted to 95% of the Standard Proctor Density to achieve the desired load-bearing capacity. (NOTE: This effectively eliminates the infiltration function of the installation, and it must be addressed during hydrologic design.)

**Step 5.** Geotextile should be installed on the bottom of the filter layer. The filter layer (2-4 inches of sand/compost mix) should be placed on top of the geotextile.

**Step 6.** Provide a minimum of 2 inches of coral stone below the underdrains. The underdrains should slope down towards the outlet at a grade of 0.5% or steeper. The up-gradient end of underdrains in the coral stone layer should be capped. Where an underdrain pipe is connected to a structure, there shall be no perforations within 1 foot of the structure. Ensure that there are no perforations in clean-outs and observation wells within 1 foot of the surface.

**Step 7.** Moisten and spread 6-inch lifts of the clean, washed coral stone. Place at least 4 inches of additional stone above the underdrain, and then compact it with at least four (4) passes of a 10-ton steel drum static roller until there is no visible movement. The first two (2) passes are in vibratory mode, with the final two (2) passes in static mode. Do not crush the coral stone with the roller.

**Step 8.** Place edge restraints for open-jointed pavement blocks before the bedding layer and pavement blocks are installed. PICP and CGP systems require edge restraints to prevent vehicle loads from moving the paver blocks. Edge restraints may be standard curbs or gutter pans, or precast or cast-in-place reinforced concrete borders a minimum of 6 inches wide and 18 inches deep, constructed with Class A3 concrete. Edge restraints along the traffic side of a permeable pavement block system are recommended. Install the bedding layer depending on the type of pavement, as follows:

- PICP: The bedding layer for open-jointed pavement blocks should consist of 2 inches of washed pea gravel. This bedding layer can be placed directly over the coral stone layer. Depending on the void ratio of the coral stone layer, an additional layer of non-woven geotextile may be needed between the coral stone and the overlying pea gravel. The designer should specify geotextile if there is risk of the pea gravel sifting down through the coral stone layer.

- CGP: For grid paver with turf grass designs, first place a geotextile above the coral stone layer. Place 2 inches of soil/compost mix above the geotextile.

**Step 9.** Paving materials shall be installed in accordance with manufacturer or industry specifications for the particular type of pavement. The basic installation process is described in greater detail by Smith (2006). The following steps were adapted from this guidance:

- Install pavement as follows:

PICP pavers may be placed by hand or with mechanical installers. Fill the joints and openings with pea gravel. Remove excess stones from the paver surface. Compact and seat the pavers into the bedding course with a minimum low-amplitude 5,000-lbf, 75- to 95-Hz plate compactor. Do not compact within 6 feet of the unrestrained edges of the pavers. The system must be thoroughly swept by a mechanical sweeper or vacuumed immediately after construction to remove any sediment or excess aggregate.

CGP: Lay the grid pavers on the bedding soil and fill the void openings with additional soil/compost mix. Remove excess soil from the paver surface. Compact and seat the pavers into the bedding layer with a minimum low-amplitude 4,000-lbf, 75- to 90-Hz plate compactor. Do not compact within 6 feet of the unrestrained edges of the pavers. Seed surface soil/compost mix with turf grass. Initial watering is recommended to promote seed establishment.

- Fill gaps at the edge of the paved areas with cut pavers or edge units. When cut pavers are needed, cut the pavers with a paver splitter or masonry saw. Cut pavers no smaller than one-third (1/3) of the full unit size.
- Inspect the area for settlement. Any areas that settle must be reset and re-inspected.
- Inspect the facility 18 to 30 hours after a significant rainfall (1/2 inch or greater) or artificial flooding to determine whether the facility is draining properly.

### Section S3.9. Maintenance

Maintenance is a crucial element to ensure the long-term performance of permeable pavement. The most frequently cited maintenance problem is surface clogging caused by organic matter and sediment. Aside from regular mowing of CGP turf grass applications, it is difficult to prescribe the specific types or frequency of maintenance tasks that are needed to maintain the hydrologic function of permeable pavement systems over time. Most installations work reasonably well year after year with little or no maintenance, whereas some have maintenance needs early in the life of the system.

One preventative maintenance task for permeable parking applications involves street sweeping on a frequency consistent with the use and loadings encountered in the

parking lot. Many consider at least an annual, dry-season sweeping to be important, and more frequent sweeping is likely needed if the contributing areas have relatively high sediment loads or are landscaped. The contract for sweeping should specify that a sweeper be used that does not use water spray, since spraying may lead to subsurface clogging. Any surface void material that is picked up or displaced during sweeping should be replaced with new, clean material.

Maintenance of permeable pavement is driven by annual inspections that evaluate the condition and performance of the practice. **Table S3.2** provides suggested annual maintenance inspection points and related actions for permeable pavements:

<b>Table S3.2. Maintenance Inspection Guidelines for Permeable Pavement Systems</b>	
<b>Regular Maintenance Activity</b>	
Mow grass paver periodically to prevent overgrowth of vegetation	
<b>Annual Inspection Activity</b>	<b>Action</b>
Inspect surface for signs of surface clogging.	Schedule a vacuum sweeper (no brooms or water spray) to remove deposited material.
Inspect the structural integrity of the pavement.	Replace or repair affected areas, as necessary.
Check inlets, pretreatment and flow diversion for sediment buildup and structural damage.	Remove sediment or repair affected areas.
Inspect contributing drainage area (CDA) for any controllable sources of sediment or erosion.	Stabilize CDA.
Measure drawdown rate in observation well after storms > 0.5 in.	Standing water after 3 days = clogging problem. Replace or repair affected areas.

**References:**

American Society for Testing and Materials (ASTM). 2003. "Standard Classification for Sizes of Aggregate for Road and Bridge Construction." *ASTM D448-03a*. West Conshohocken, PA.

Hirschman, D., L. Woodworth and S. Drescher. 2009. *Technical Report: Stormwater BMPs in Virginia's James River Basin: An Assessment of Field Conditions & Programs*. Center for Watershed Protection. Ellicott City, MD.

Smith, D. 2006. *Permeable Interlocking Concrete Pavement-selection design, construction and maintenance. Third Edition*. Interlocking Concrete Pavement Institute. Herndon, VA.

## Island BMP Specification #4: Rainwater Harvesting



## **Island BMP Specification #4: Rainwater Harvesting**

***Supplemental Design Criteria for the CNMI & Guam Stormwater Management Manual, 2006. To be added as supplement to Volume 1, Chapter 3***

### **Section S4.1. Introduction**

Rainwater harvesting systems intercept, divert, and store rainfall for future use. Rainwater that falls on a rooftop is collected and conveyed into an above or below ground storage tank where it can be used for non-potable water uses and on-site stormwater infiltration. Non-potable uses may include flushing of toilets and urinals inside buildings, landscape irrigation, exterior washing (e.g. car washes, building facades, sidewalks, street sweepers, fire trucks, etc.), fire suppression (sprinkler) systems, supply for chilled water cooling towers, dust control, replenishing and operation of water features and water fountains, and laundry, if approved by the local authority. Replenishing of pools may be acceptable if special measures are taken, as approved by the appropriate regulatory authority.

In certain cases, harvested rainwater can be used for small-scale potable water supply (see **Figure S4.1**) if approved by the proper regulatory authority. Appropriate treatment systems to treat water to potable standards would need to be added to the system components.

This type of system is recommended for CNMI and Guam to: (1) reduce the volume of stormwater generated, and (2) relieve pressure on the potable water supply. This can be particularly relevant for Guam's northern aquifer region, where both recharge and reducing demand may be important objectives in light of increased demand for this resource. Rainwater harvesting can be adapted to the wet season and dry season conditions by adding a "soakaway" valve to help drain the tank during the wet season and/or adjusting the indoor and outdoor uses of the water.

Treatment Suitability: Rainwater harvesting systems are flexible and can be designed to manage the water quality volume ( $WQ_v$ ), the channel protection volume ( $Cp_v$ ), and/or overbank flood storage ( $Q_{p-25}$ ). The design volumes and flows are dependent on the size of the tank or cistern selected as well as the year-round demand for reuse of the water. The recharge volume ( $Re_v$ ) can also be managed by using rainwater harvesting in combination with a downgradient infiltration practice (e.g., infiltration trench, rain garden).



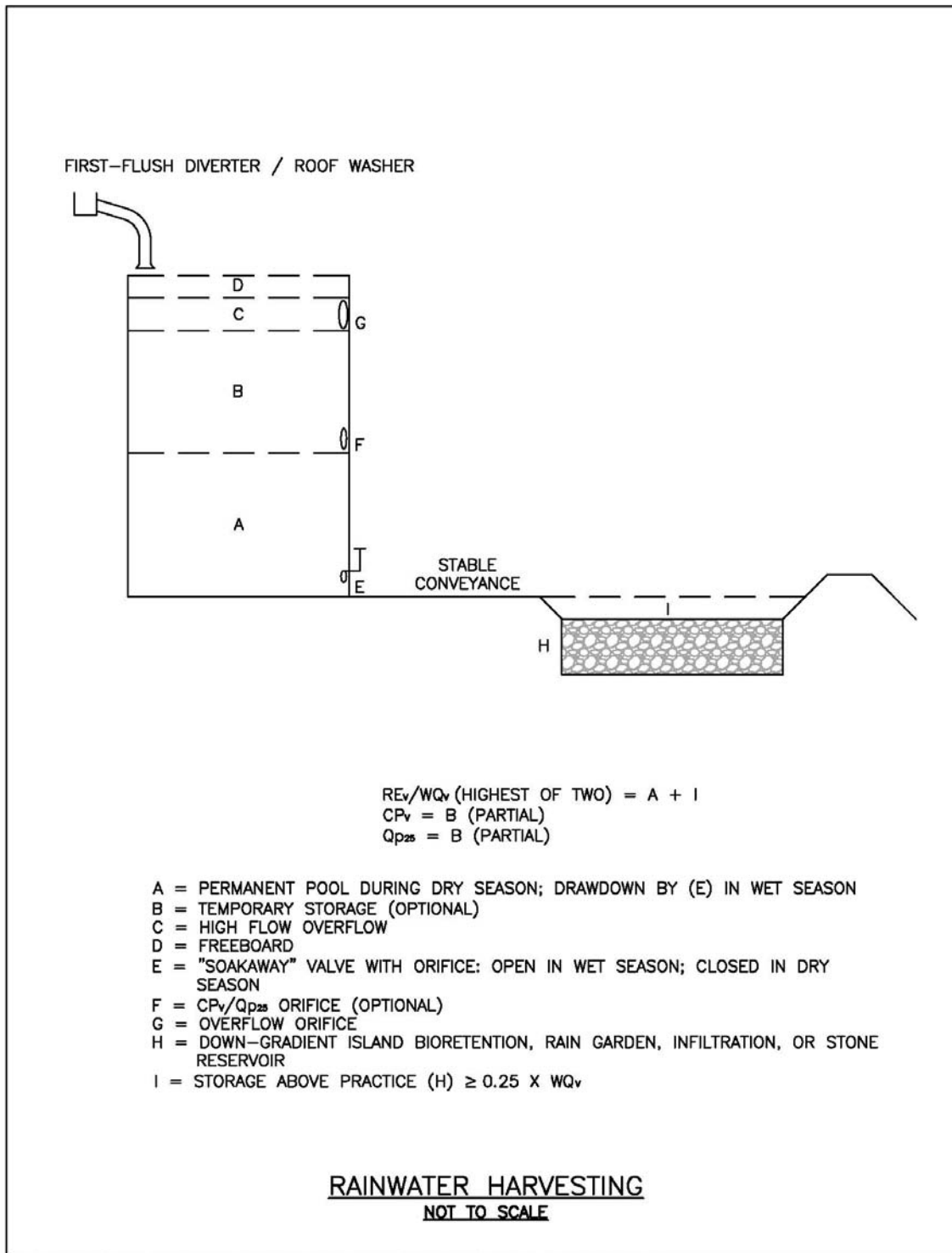
**Figure S4.1. Examples of rainwater harvesting for backup potable and other uses on Saipan**

## Section S4.2. Typical Details

**Figure S4.2** shows a typical configuration for an above ground rainwater harvesting tank with wet season and dry season operation. The figure shows the tank draining to a downgradient small infiltration practice. This configuration helps to meet recharge criteria and also provides some treatment for water that overflows the tank, goes through the first-flush diverter, and/or cannot be fully used for indoor or outdoor water uses.

The figure also shows how the various storage volumes referenced in the *CNMI and Guam Stormwater Management Manual* can be “stacked” in order to meet the design criteria.





H:\Projects\2009\9039 NOAA Coral Reef Program\Drawings\RAINWATERHARVESTING.dwg

**Figure S4.2. Typical configuration for rainwater harvesting**

## Section S4.3. Feasibility

The following considerations and design guidance are important when planning and implementing rainwater harvesting systems.

**Available Space.** Rainwater harvesting tends to be very space-efficient, compared to other stormwater practices. However, adequate space is needed to house the tank and any overflow. Underground utilities or other obstructions should always be identified prior to final determination of the tank location.

**Site Topography.** Site topography and tank location should be considered as they relate to all of the inlet and outlet invert elevations in the rainwater harvesting system. The total elevation drop will be realized beginning from the downspout leaders to the final mechanism receiving gravity-fed discharge and/or overflow from the cistern.

**Available Hydraulic Head.** The required hydraulic head depends on the intended use of the water. For residential landscaping uses, the cistern should be sited on a raised platform or up-gradient from the landscaping areas. Pumps are commonly used to convey stored rainwater to the end use in order to provide the required pressure.

**Water Table.** Underground storage tanks are most appropriate in areas where the tank can be buried *above* the water table. The tank should be located in a manner that will not subject it to flooding. In areas where the tank is to be buried below the water table, special design features must be employed, such as sufficiently securing the tank (to keep it from “floating”), conducting buoyancy calculations when the tank is empty, etc. The tank must also be installed according to the tank manufacturer’s specifications.

**Proximity of Underground Utilities.** All underground utilities must be taken into consideration during the design of underground rainwater harvesting systems. Appropriate minimum setbacks from septic drainfields should be observed, as specified by appropriate municipal codes.

**Contributing Drainage Area.** The contributing drainage area (CDA) to the cistern is the impervious area draining to the tank. In general, only rooftop surfaces should be included in the CDA. Parking lots and other paved areas can be used in rare circumstances with appropriate treatment (oil/water separators) and approval of the plan-approving authority. Runoff should be routed directly from rooftops to rainwater harvesting systems in closed roof drain systems or storm drain pipes, avoiding surface drainage, which could allow for increased contamination of the water.

**Rooftop Material.** The quality of the harvested rainwater will vary according to the roof material over which it flows. Water harvested from certain types of rooftops, such as asphalt sealcoats, tar and gravel, painted roofs or galvanized metal roofs, may leach trace metals and other toxic compounds. In general, harvesting rainwater from such roofs should be avoided, unless new information determines that these materials are sufficient for the intended use and are allowed by regulations.

**Hotspot Land Uses.** Harvesting rainwater can be an effective method to prevent contamination of rooftop runoff that would result from mixing it with ground-level runoff from a stormwater hotspot operation. In some cases, however, industrial roof surfaces may also be designated as stormwater hotspots.

**Setbacks from Buildings.** Cistern overflow devices should be designed to avoid causing ponding or soil saturation within 10 feet of building foundations. Storage tanks should be designed to be watertight to prevent water damage when placed near building foundations. In general, it is recommended that underground tanks be set at least 10 feet from any building foundation.

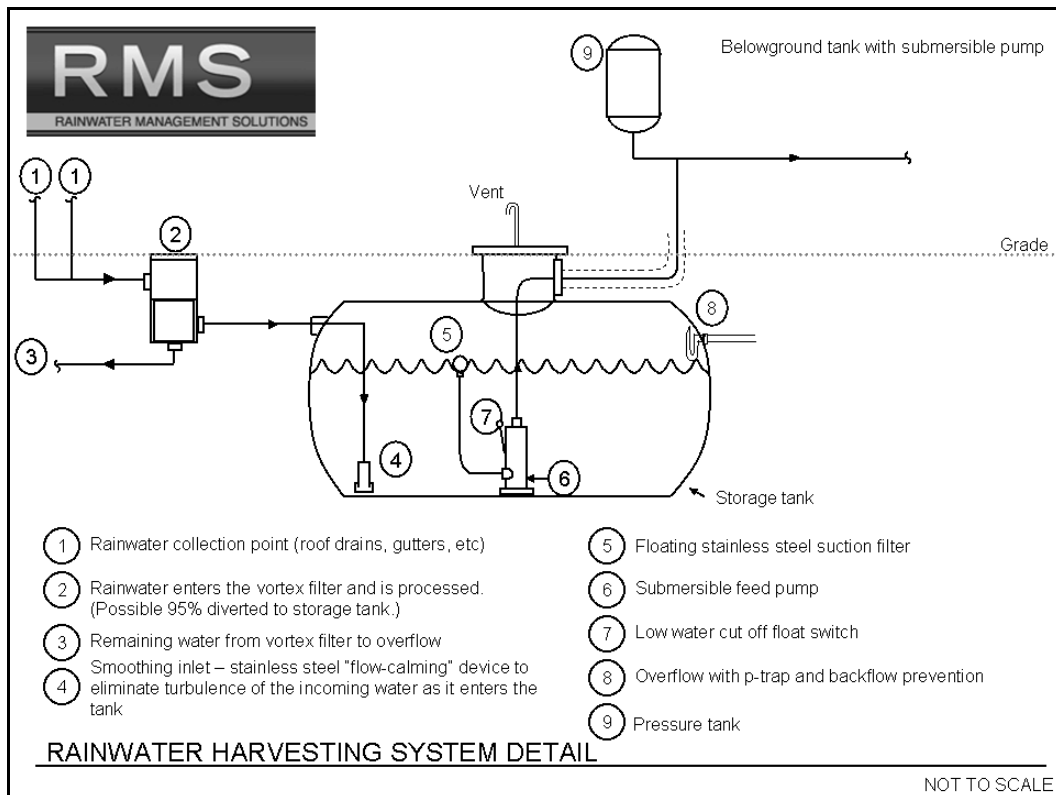
**Vehicle Loading.** Whenever possible, underground rainwater harvesting systems should be placed in areas without vehicle traffic or be designed to support live loads from heavy trucks, a requirement that may significantly increase construction costs.

## Section S4.4. Design Components

There are six primary components of a rainwater harvesting system:

- Rooftop surface
- Collection and conveyance system (e.g. gutter and downspouts)
- Pre-treatment: Screening, First-Flush Diverters, and Filters
- Storage tanks
- Distribution system
- Down-gradient small infiltration practice

**Figure S4.3** illustrates the typical system components for rainwater harvesting described in this section, using an underground tank as an example.



**Figure S4.3. Typical system components for rainwater harvesting. Graphic courtesy of Rainwater Management Solutions, Inc.**

**Rooftop Surface.** The rooftop should be made of smooth, non-porous material with efficient drainage either from a sloped roof or an efficient roof drain system. Slow drainage of the roof leads to poor rinsing and a prolonged first flush, which can decrease water quality. If the harvested rainwater will be used for potable uses, or uses with significant human exposure (e.g. pool filling, watering vegetable gardens), care should be taken in the choice of roof materials. Some materials may leach toxic chemicals making the water unsafe for humans (see Section S4.3 for more detail).

**Collection and Conveyance System.** The collection and conveyance system consists of the gutters, downspouts and pipes that channel stormwater runoff into storage tanks. Gutters and downspouts should be designed as they would for a building without a rainwater harvesting system. Aluminum, round-bottom gutters and round downspouts are generally recommended for rainwater harvesting. Minimum slopes of gutters should be specified. They should be designed to convey the 10-year storm, specifying size and minimum slope, if credit will be sought for channel protection and/or overbank flood control. In all cases, gutters should be installed at a minimum of 0.5% slope for 2/3 of the length and at 1% for the remaining 1/3 of the length nearest the storage tank.

Pipes (connecting downspouts to the cistern tank) should be at a minimum slope of 1.5% and sized/ designed to convey the intended design storm. In some cases, a steeper slope and larger sizes may be recommended and/or necessary to convey the required runoff. Gutters and downspouts should be kept clean and free of debris and rust.

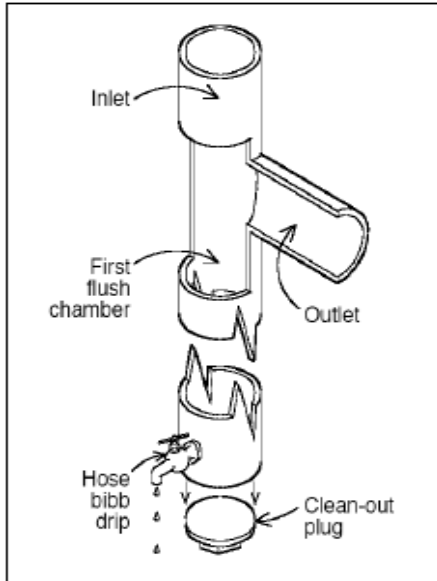
***Pre-Treatment: Screening, First Flush Diverters and Filters.*** Pre-filtration is required to keep sediment, leaves and vegetative debris, contaminants and other debris from the system. Leaf screens and gutter guards meet the minimal requirement for pre-filtration of small systems (such as residential and small-scale commercial applications), although direct water filtration is preferred. All pre-filtration devices should be low-maintenance or maintenance-free. The purpose of pre-filtration is to significantly cut down on system maintenance by preventing organic buildup in the tank, thereby decreasing microbial food sources.

For larger tank systems, the initial first flush must be diverted from the system before rainwater enters the storage tank. The amount of this diversion can range between the first 0.02 to 0.06 inches of rooftop runoff.

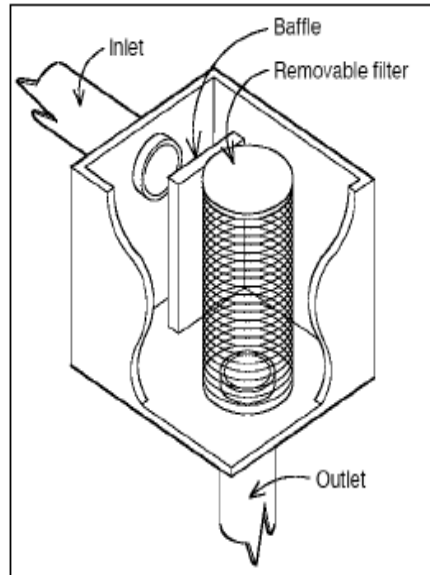
The diverted flows (first flush diversion and overflow from the filter) must be directed to an acceptable pervious flow path, that will not cause erosion during a 2-year storm, or to an appropriate stormwater practice on the property, such as a down-gradient small infiltration practice (which can also receive overflow from the tank itself).

Various pre-treatment mechanisms are described below.

- ***Leaf Screens (small-scale applications).*** Leaf screens are mesh screens installed over either the gutter or downspout to separate leaves and other large debris from rooftop runoff. Leaf screens must be regularly cleaned to be effective; if not maintained, they can become clogged and prevent rainwater from flowing into the storage tanks. Built-up debris can also harbor bacterial growth within gutters or downspouts.
- ***First Flush Diverters.*** First flush diverters direct the initial pulse of stormwater runoff away from the storage tank. While leaf screens effectively remove larger debris such as leaves, twigs and blooms from harvested rainwater, first flush diverters can be used to remove smaller contaminants such as dust, pollen and bird and rodent feces (**Figure S4.4**). Simple first flush diverters require active management, by draining the first flush water volume to a pervious area following each rainstorm. First flush diverters may be the preferred pre-treatment method if the water is to be used for indoor purposes. A vortex filter (see below) may serve as an effective pre-tank filtration device and first flush diverter.
- ***Roof Washers.*** Roof washers are placed just upgradient of storage tanks and are used to filter small debris from harvested rainwater (**Figure S4.5**). Roof washers consist of a tank, usually between 25 and 50 gallons in size, with leaf strainers and a filter with openings as small as 30-microns. The filter functions to remove very small particulate matter from harvested rainwater. All roof washers must be cleaned on a regular basis.



**Figure S4.4. First Flush Diverter**



**Figure S4.5. Roof Washer**

- **Vortex Filters**. For larger rooftop areas, vortex filters are recommended to provide filtering of rooftop rainwater. Two images of the vortex filter are displayed below. The first image (**Figure S4.6**) provides a plan view photograph showing the interior of the filter with the top off. The second image (**Figure S4.7**) displays the filter just installed in the field prior to backfill.

In addition to the initial first flush diversion, filters have an associated efficiency curve that estimates the percentage of rooftop runoff that will be conveyed through the filter to the storage tank. If filters are not sized properly, a large portion of the rooftop runoff may be diverted and not conveyed to the tank for storage. To receive credit for capturing the water quality volume ( $WQ_v$ ), the minimum filter efficiency should be 95% for a rainfall intensity of 1" per hour (approximately 0.01 gallons/minute per square foot of roof area), with higher design rainfall intensities depending on the design objectives and capture rates for the overall rainwater harvesting system.



**Figure S4.6. Interior of Vortex Filter**



**Figure S4.7. Installation of Vortex Filter prior to backfill**

**Storage Tanks.** The storage tank is the most important and typically the most expensive component of a rainwater harvesting system. Cistern capacities range from 250 to over 30,000 gallons. Multiple tanks can be placed adjacent to each other and connected with pipes to balance water levels and increase overall storage as needed. Typical rainwater harvesting system capacities for residential use range from 1,500 to 5,000 gallons. Storage tank volumes are calculated to meet the water demand and stormwater treatment volume standards.

As shown in **Figure S4.2**, treatment volumes can be “stacked” to meet water quality, channel protection, and/or overbank flood control standards. However, smaller tanks that meet only the water quality standard can also be coupled with other downgradient practices that manage the channel protection and flood control requirements (e.g., rainwater tanks that drains to a downgradient multi-cell ponding basin).

Rainwater harvesting tanks can be made of many materials and configured in various shapes, depending on the type used, the site conditions, and the availability of various tanks (see **Figure S4.8**). For example, configurations can be rectangular, L-shaped, or step down vertically to match the topography of a site. The following factors that should be considered when designing a rainwater harvesting system and selecting a storage tank:

- Aboveground storage tanks should be UV and impact resistant.
- Underground storage tanks must be designed to support the overlying soil and any other anticipated loads (e.g., vehicles, pedestrian traffic, etc.).
- Underground rainwater harvesting systems should have a standard size manhole or equivalent opening to allow access for cleaning, inspection, and maintenance purposes. This access point should be secured/locked to prevent unwanted access.
- All rainwater harvesting systems should be sealed using a water-safe, non-toxic substance.
- For use during both wet and dry seasons, tanks should have a “soakaway valve” near the bottom (above the dead storage). This valve can be left open during the wet season to help keep the tank draining, and closed during the dry season to maximize storage for other uses. The valve can also be adjustable to allow the correct balance between tank drainage and other uses.
- Rainwater harvesting systems may be ordered from a manufacturer or can be constructed on site from a variety of materials. **Table S4.1** below compares the advantages and disadvantages of different storage tank materials.
- Storage tanks should be opaque or otherwise protected from direct sunlight to inhibit algae growth and should be screened to discourage mosquito breeding and reproduction.
- Dead storage below the outlet to the distribution system and an air gap at the top of the tank should be added to the total volume. For gravity-fed systems, a minimum of 6 inches of dead storage should be provided. For systems using a pump, the dead storage depth will be based on the pump specifications.
- Any hookup to a municipal backup water supply should have a backflow prevention device to keep municipal water separate from stored rainwater; this may include incorporating an air gap to separate the two supplies. Local codes may have specifications for this.



<b>Table S4.1. Advantages &amp; Disadvantage of Various Cistern Materials</b>		
<b>Tank Material</b>	<b>Advantages</b>	<b>Disadvantages</b>
<b>Fiberglass</b>	Commercially available, alterable and moveable; durable with little maintenance; light weight; integral fittings (no leaks); broad application	Must be installed on smooth, solid, level footing; pressure proof for below-ground installation; expensive in smaller sizes
<b>Polyethylene</b>	Commercially available, alterable, moveable, affordable; available in wide range of sizes; can install above or below ground; little maintenance; broad application	Can be UV-degradable; must be painted or tinted for above-ground installations; pressure-proof for below-ground installation
<b>Modular Storage</b>	Can modify to topography; can alter footprint and create various shapes to fit site; relatively inexpensive	Longevity may be less than other materials; higher risk of puncturing of water tight membrane during construction
<b>Plastic Barrels</b>	Commercially available; inexpensive	Low storage capacity (20 to 50 gallons); limited application
<b>Galvanized Steel</b>	Commercially available, alterable and moveable; available in a range of sizes; film develops inside to prevent corrosion	Possible external corrosion and rust; must be lined for potable use; can only install above ground; soil pH may limit underground applications
<b>Steel Drums</b>	Commercially available, alterable and moveable	Small storage capacity; prone to corrosion, and rust can lead to leaching of metals; verify prior to reuse for toxics; water pH and soil pH may also limit applications
<b>FerroConcrete</b>	Durable and immovable; suitable for above or below ground installations; neutralizes acid rain	Potential to crack and leak; expensive
<b>Cast in Place Concrete</b>	Durable, immovable, versatile; suitable for above or below ground installations; neutralizes acid rain	Potential to crack and leak; permanent; will need to provide adequate platform and design for placement in clay soils
<b>Stone or concrete Block</b>	Durable and immovable; keeps water relatively cool in hot climates	Difficult to maintain; expensive to build

**Distribution System.** Most distribution systems require a pump to convey harvested rainwater from the storage tank to its final destination, whether inside the building, an automated irrigation system, or gradually discharged to a downgradient infiltration practice. The rainwater harvesting system should be equipped with an appropriately-sized pump that produces sufficient pressure for all end-uses. The municipality may require the separate plumbing to be labeled as non-potable.

The typical pump and pressure tank arrangement consists of a multi-stage centrifugal pump, which draws water out of the storage tank and sends it into the pressure tank, where it is stored for distribution. When water is drawn out of the pressure tank, the pump activates to supply additional water to the distribution system. The backflow preventer is required to separate harvested rainwater from the main potable water distribution lines. A drain plug or cleanout sump, also draining to a pervious area, should be installed to allow the system to be completely emptied, if needed.

***Overflow, Filter Path, and Downgradient Small Infiltration or Treatment Practice.*** An overflow mechanism should be included in the rainwater harvesting system design in order to handle an individual storm event or multiple storms in succession that exceed the capacity of the tank (especially during the wet season). Overflow pipes should have a capacity equal to or greater than the inflow pipe(s) and have a diameter and slope sufficient to drain the cistern while maintaining an adequate freeboard height. The overflow pipe should be screened to prevent access to the tank by rodents and birds.

The overflow and first-flush diversion filter path is a pervious, grass, or adequately lined corridor that extends from the overflow to the next stormwater practice, the street, an adequate existing or proposed channel, or the storm drain system. The filter path must be graded with a slope that results in sheet flow or positive drainage conditions. If compacted or impermeable soils are present along the filter path, compost amendments may be needed.

It is likely that wet season operation will involve frequent or continuous drainage of the tank, through the soakaway valve, to a downgradient practice. This practice is essential for helping to meet targeted storage volumes (see **Figure S4.2**). The downgradient practice can be a simple stone-filled trench for small applications, or one of the other practices described in Volume 1, Chapter 3 of the *CNMI/Guam Stormwater Management Manual*, or supplemental specifications. Note that infiltration practices must meet the infiltration testing standards outlined in the Manual and supplements.



**Figure S4.8. Various tank materials and configurations**

## Section S4.5. Construction Sequence

A standard construction sequence for a rainwater harvesting system installation is provided below. This can be modified to reflect different rainwater harvesting system applications or expected site conditions.

- Choose the tank location on the site
- Route all downspouts or roof drains to pre-screening devices and first flush diverters
- Properly install the tank according to the manufacturer's recommendations, if applicable
- Install the pump (if needed) and piping to end-uses (indoor, outdoor irrigation, or tank dewatering release)
- Stabilize the overflow filter path with vegetation or appropriate lining.
- Route all pipes to the tank. Stormwater should not be diverted to the rainwater harvesting system until the overflow filter path has been completely stabilized.

## Section S4.6. Maintenance

Maintenance requirements for rainwater harvesting systems vary according to use. Systems that are used to provide supplemental irrigation water have relatively low maintenance requirements, while systems designed for indoor uses have much higher maintenance requirements. **Table S4.2** describes routine maintenance tasks to keep rainwater harvesting systems in working condition.

<b>Table S4.2. Maintenance Guidelines for Rainwater Harvesting Systems</b>	
<b>Activity</b>	<b>Frequency</b>
Keep gutters and downspouts free of leaves and other debris	Twice a year
Inspect and clean pre-screening devices and first flush diverters	Four times a year
Operate soakaway valve for wet and dry season operation	Twice a year or more
Inspect and clean storage tank lids, paying special attention to vents and screens on inflow and outflow spigots. Check mosquito screens and patch holes or gaps immediately. Clean and flush the tank itself if needed	Once a year, prior to wet season
Inspect condition of overflow pipes, overflow filter path and/or secondary runoff reduction practices	Once a year
Inspect tank for sediment buildup	Every third year
Clear overhanging vegetation and trees over roof surface	Every third year
Check integrity of backflow preventer	Every third year
Inspect structural integrity of tank, pump, pipe and electrical system	Every third year
Replace damaged or defective system components	Every third year

Note for Rainwater Harvesting Specification

This specification was adapted from the rainwater harvesting specification from the Virginia Stormwater BMP Clearinghouse. The Clearinghouse specification can be downloaded for additional guidance on design and sizing of rainwater harvesting systems.

<http://www.vwrrc.vt.edu/swc/NonProprietaryBMPs.html>

## Rainwater Harvesting



Description: **Various configurations of above or below ground storage tanks to intercept, divert, and store rainfall for future outdoor and indoor uses.**

**Design Practices: Rainwater Harvesting (Supplement #4)**

### KEY CONSIDERATIONS

#### CONVEYANCE

- Consists of the gutters, downspouts and pipes that channel stormwater runoff into storage tanks.
- Designed to convey 10-year storm flow

#### PRETREATMENT

- Pretreatment consists of leaf screens, first-flush diverters, roof washers, or vortex filters, depending on scale of application, as described in **Section S4.4**.

#### TREATMENT

- Various sizes and configurations of storage tanks, plus down-gradient infiltration or treatment practice, as described in **Section S4.4**.
- “Treatment” depends on type and magnitude of demand for collected water.

#### LANDSCAPING

- Applicable to down-gradient infiltration practice, such as small rain garden. See **Specification S2, Island Bioretention**, for recommended plant list.

#### MAINTENANCE REQUIREMENTS:

- See maintenance activities and frequencies in **Section S4.6**.

### STORMWATER MANAGEMENT SUITABILITY

- Water Quality**
- Recharge**
- Channel Protection (partial)**
- Overbank Flood (partial)**

Accepts Hotspot Runoff: *Should not collect runoff from hotspots, although “clean” rooftops at hotspot land uses are acceptable if water is kept separate from site runoff.*

### IMPLEMENTATION CONSIDERATIONS

- Capital Cost**
- Maintenance Burden**

Residential/Subdivision Use: *Yes*  
High Density/Ultra-Urban: *Yes*

Drainage Area: *Rooftops*

Soils: *Downgradient infiltration practices should ensure proper soils.*

Other Considerations:

**Year-round indoor and outdoor uses increase demand and feasibility of practice**

Key: L=Low M=Moderate H=High

**POLLUTANT REMOVAL**

- F Phosphorus
- F Nitrogen
- F Metals - Cadmium, Copper, Lead, and Zinc removal
- F Pathogens - Coliform, *Streptococci*, *E. coli* removal

**Key: G=Good F=Fair P=Poor**

## **Island BMP Specification (General): Soil/Compost Mix for Island Bioretention, Permeable Parking and Walkway, and Multi-Cell Ponding Basin Designs**

***Supplemental Design Criteria for the CNMI & Guam Stormwater Management Manual, 2006. To be added as supplement to Volume 1, Chapter 3.***

**(See Supplemental Specifications #S1, S2, and S3 for detailed design guidance for each BMP)**

Conventional bioretention uses an engineered soil mix to provide pollutant filtering and a media for plant growth. This mix is composed of construction sand (as much as 85%), a loamy sand soil, and organic material, such as leaf compost.

This type of material will have to be fabricated for Island Bioretention, Permeable Parking and Walkway, and Multi-Cell Ponding Basin applications as a complementary layer to coral stone (see applicable supplemental design specifications). All runoff must pass through the soil/compost layer before and/or after passing through the coral stone layer. The reasons for this are that:

- The coral stone has a relatively high pH, and metals may leach from runoff or the surrounding soil without some pH adjustment provided by the soil/compost.
- The coral stone is very coarse and, alone, would not provide adequate filtering of the runoff to provide the desired level of pollutant removal.
- The soil/compost also has a lower hydraulic conductivity (drains slower) than the coral stone, so more flow reduction will be achieved.

Various compost mixtures have been studied on Guam for the purposes of enhancing agricultural soils (Golabi, *et al.*, 2006). This compost was produced from tree trimmings from roadsides, animal manure from farms, and wood chips from typhoon debris. The compost was produced in piles with perforated pipes to supply air, and the piles were mixed periodically with a backhoe (Golabi, *et al.*, 2006).

This same type of method would be appropriate for Island BMP applications, EXCEPT that the proportion of chicken, hog, and/or horse manure should be kept very low. Animal manure will increase the nutrient content of the compost to the level where nutrient leaching from the compost is likely, and bacteria export may also be a concern. However, some organic content may be needed to promote growth of plants within bioretention areas.

In general, the following plant materials may be widely available and can be considered for use to produce Island BMP compost:

- Tangan-tangan debris from roadsides – chipped or ground
- Coconut palms debris – chipped or ground
- Plant waste from farms
- A SMALL amount of well-composted animal manure from farms

The compost can be produced in actively-turned windrows, passively aerated windrows (perforated pipes), actively aerated windrows (forced air), bins, or silos (Golabi, *et al.*,

2006). In general, the compost should have the following physical characteristics after composting (Hinman, 2009):

- Earthy smell that is not sour, sweet, or ammonia-like.
- Brown to black in color.
- Mixed particle sizes.
- Stable temperature and does not get hot when re-wetted.
- Crumbly texture.

In order for the compost to have the proper characteristics for pollutant removal, and to avoid leaching pollutants as stormwater passes through the compost, the following testing standards are provided as guidelines (Virginia DCR, 2009). These standards can be modified as compost mixes are produced for actual Island Bioretention applications and some monitoring of the effluent is performed.

pH	< 7.3
Bulk Density	1.6 to 1.7 g/cm <sup>3</sup>
Phosphorus	7 to 23 mg/kg
Carbon/Nitrogen Ratio (C/N)	> 25:1
Cation Exchange Capacity (CEC)	> 0.1 meq/g soil
Soil Fines	< 5%

Once produced, the soil/compost mix should be placed within the Island Bioretention, Permeable Parking/Walkway, and vegetated filter cell of Multi-Cell Ponding Basin facilities so that all runoff passes through the soil/compost layer before and/or after passing through the coral stone layer.

The soil/compost and coral stone layers are separated by a layer of needle-punched, non-woven geotextile fabric to keep the soil/compost particles from migrating into the stone, while still allowing flow to pass between the layers.

The individual BMP specifications contain more information on materials specifications and construction methods.

### References

Golabi, M.H., P. Denney and C. Iyekar. *Composting of Disposal Organic Wastes: Resource Recovery for Agricultural Sustainability*. The Chinese Journal of Process Engineering. Vol. 6, No. 4, August 2006.

Hinman, C. *Bioretention Soil Mix Review and Recommendations for Western Washington*, WSU Extension, produced for Puget Sound Partnership, January 2009.

Virginia Department of Conservation & Recreation. *Stormwater Design Specification #9, Bioretention, Version 1.6*, September 30, 2009. Virginia Stormwater BMP Clearinghouse: <http://www.vwrrc.vt.edu/SWC/index.html>



**Island BMP Specification (General): Field Test for Determining Hydraulic Conductivity in accordance with ASTM D5126-90 Method (Infiltration Testing)**

*Supplemental Design Criteria for the CNMI & Guam Stormwater Management Manual, 2006. To be added as supplement to Volume 1, Chapter 3 & Volume 2.*

(See Supplemental Specifications #S1, S2, S3, and S4 for detailed design guidance for each BMP)

Field Test for Determining Hydraulic Conductivity in accordance with ASTM D5126-90 Method.

1. Saturated hydraulic conductivity rates should be determined in the field at the actual location and depth of the proposed practice.
2. The field method should consist of a constant or falling head permeability test performed in accordance with ASTM D5126-90 **“Standard Guide for Comparison of Field Methods for Determining Hydraulic Conductivity in the Vadose Zone”**
3. The Guelph Permeameter, the Amoozemeter (also referred to as an Amoozegar Permeameter), and a falling head permeameter are all acceptable equipment to conduct the test. A double ring permeameter (also referred to as an infiltrometer) is not recommended for determining hydraulic conductivity in limestone deposits because of the difficulty in maintaining a seal in the shallower soils due to the presence of rock fragments.
4. Standard percolation testing procedures used for designing septic systems are not an acceptable method for determining design rates for stormwater management practices.