

St. Croix East End Watersheds Management Plan

U.S. Virgin Islands

FINAL November 2011

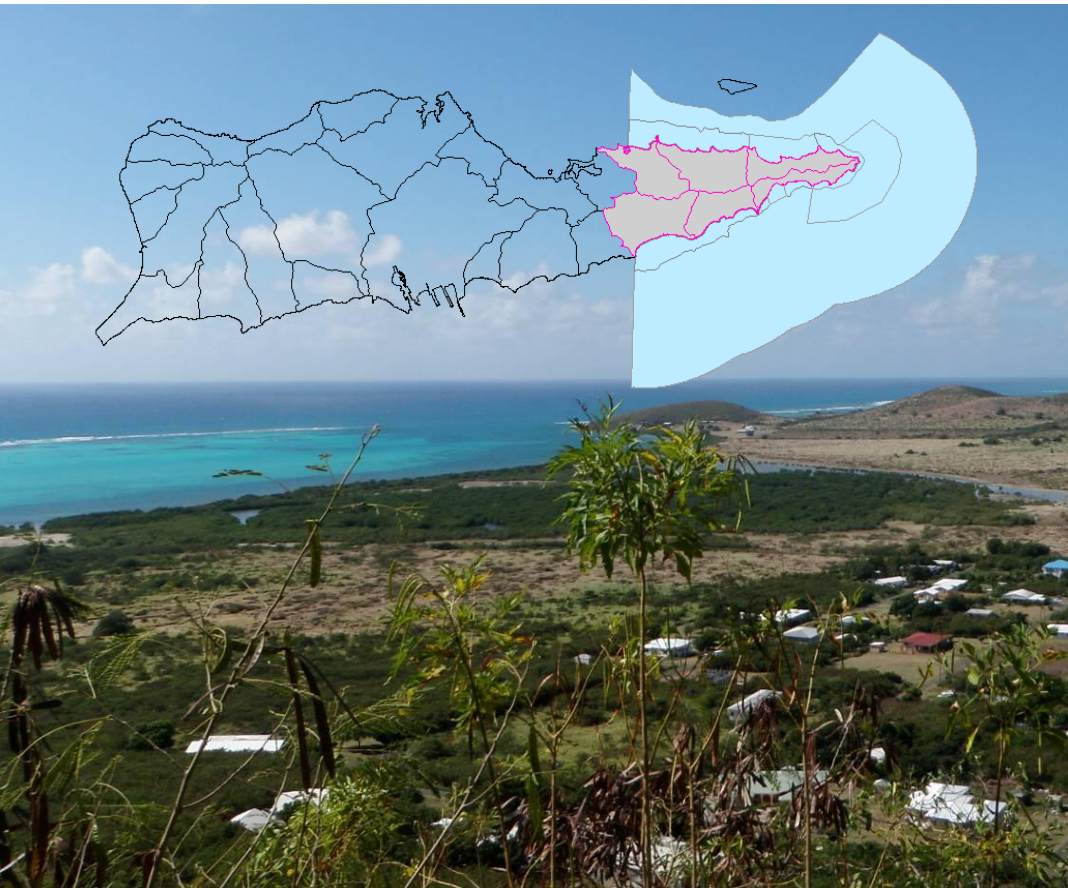

Prepared for:

St. Croix East End Marine Park
USVI Department of Planning and Natural Resources
NOAA Coral Reef Conservation Program
USDA-NRCS, St. Croix Field Office

Prepared by:

Horsley Witten Group, Inc
90 Route 6A, Sandwich, MA, 02563
www.horsleywitten.com



Acknowledgements

In addition to the Horsley Witten Group, the project planning team consisted of Jen Kozlowski, Rob Ferguson, and Marlon Hibbert with the NOAA Coral Conservation Program; Paige Rothenberger (DPNR); Julie Wright (USDA); Jeanne Brown (TNC); and Carol Cramer-Burke (SEA). Paige Rothenberger was the original inspiration for this project and served as the primary contact. East End Marine Park staff assisted in coordinating public meetings and conducting site investigations. Julie Wright provided significant technical guidance, historical perspective, peer review services, and coordination with local property owners. Jeanne Brown and Carol Cramer-Burke provided a non-agency perspective to the planning team and have taken a lead on early implementation funding proposals.

Other agency staff that has provided technical assistance on this project include: Robert Cintron (DPW) and Diane Capehart, Anita Nibbs, Alexis Doward, Courtney Dickenson, Ben Keularts, Syed Syedali, and Emanuel Liburd (DPNR). Pedro Nieves (DPNR CZM) provided much of the GIS data used for mapping and analysis. Additional technical assistance related to pollutant loadings associated with unpaved roads and wastewater package plants was provided by Carlos Ramos-Scharron and Mirko Restivic, respectively.

We also want to thank all of the individuals who attended public meetings held during the course of the project, and especially those who met with us in the field including: Robert Schuster, May Cornwall and the Adams Family; Mike Hanne, Rubin Roebuck, Josh Tate, David Kagan, Don Sallach, Michael Henry, Lin Thomas, Mirok Restivic, Rhonda Dossman, Carlos Skov, and Richard Gideon, among others.

We wish to thank Julie San Martin and the St. Croix Yacht Club as well as Zandy Hillis-Starr and the National Park Service for hosting public meetings.



Table of Contents

Acknowledgements	ii
List of Acronyms	iv
1.0 Introduction	1
1.1 The East End Watersheds	1
1.2 Pollutant Loading from the East End Watersheds	4
1.2.1 Existing Pollutant Load Estimates	5
1.2.2 Future Load Additions and Potential Load Reductions	7
1.2.3 Implications for Watershed Management	9
1.3 Purpose of the Plan	10
1.4 Caveats	11
2.0 Goals and Management Recommendations	13
3.0 Structural Management Practices	17
3.1 Stormwater Retrofits	17
3.2 Gut Stabilization and Buffer Enhancement	22
3.3 Unpaved Road Stabilization	25
3.4 Culvert Repair and Replacement	27
4.0 Non-Structural Management Activities	35
4.1 Pollution Prevention	35
4.2 Regulations, Programs, and Policies	37
4.3 Education and Outreach	40
4.3.1 Targeting the Residential Community	40
4.3.2 Targeting the Business Community	42
4.3.3 Targeting the Agricultural Community	43
4.3.4 Targeting the Regulatory Community	43
4.3.5 Targeting the Tourists	44
5.0 Implementation Strategy	45
5.1 Preliminary Implementation Schedule	45
5.2 Individual Watershed Implementation Priorities	46
5.3 Evaluating Implementation Progress	46
Appendices	
Appendix A: Methods for Estimating Pollutant Loads and Ranking Projects	
Appendix B: Watershed Management Maps	
Appendix C: Priority Restoration Project Summaries	

List of Acronyms

APC	Area of Particular Concern
BMP	Best Management Practice
CZM	Coastal Zone Management
DPNR	Department of Planning and Natural Resources
DEP	Division of Environmental Protection
DFW	Division of Fish and Wildlife
DP	Division of Planning
DPW	Department of Public Works
EPA	Environmental Protection Agency
GP	Great Pond Bay watershed
LBSP	Land-Based Sources of Pollution
MC	Madam Carty watershed
NPS	National Park Service
NOAA	National Oceanic and Atmospheric Administration
SB	Solitude Bay watershed
SEA	St. Croix Environmental Association
SG	Southgate watershed
STXEEMP	St. Croix East End Marine Park
TB	Teague Bay watershed
TEMA	Territorial Emergency Management Agency
TH	Turner Hole watershed
TMDL	Total Maximum Daily Load
TNC	The Nature Conservancy
TPDES	Territorial Pollution Discharge Elimination System
USDA-NRCS	US Department of Agriculture-Natural Resource Conservation Services



1.0 Introduction

The environmental resources within St. Croix’s East End Marine Park (STXEEMP)—a 60 square mile marine area surrounding the East End of St. Croix, US Virgin Islands (USVI)—are arguably some of the greatest natural assets of the US Virgin Islands. A diversity of users including residents, fishermen, tourist-dependent businesses, recreationists, and scientists rely on the protection of these resources from over-use, water quality degradation, and habitat loss. These impacts can jeopardize continued use and may ultimately reduce ecosystem resiliency to storm damage and climate change.

It is within this context, that the NOAA Coral Reef Conservation Program has sponsored efforts to evaluate land-based sources of pollution (LBSP) and identify management alternatives to help minimize impacts stemming from the six watersheds surrounding the STXEEMP.

1.1 The East End Watersheds

Collectively, the East End watersheds are approximately 12 square miles and include Southgate, Solitude Bay, Teague Bay, Turner Hole, Madam Carty, and Great Pond Bay watersheds (Figure 1). Land use in the East End is predominantly undeveloped (Table 1), and includes the Southgate Reserve and a large conservation/park area at the eastern most end of the island. Agricultural and pasture lands and single-family neighborhoods are scattered throughout the East End, but some higher density resorts and condominiums are found along the north shore and the southern coast of Turner Hole. Commercial businesses are basically limited to a few restaurants, a marina and yacht club, a gas station, water company, and storage facility.

Average annual rainfall ranges from approximately 38-42 inches across the six watersheds, and is typically drier on the southern side of the interior slopes running east to west across the East End. Soils in areas suitable for development are mostly poorly draining and not ideal for septic systems, which is the predominant form of waste water management other than small package plants at resorts and condos.

There are eight receiving water assessment units in St. Croix’s East End that are included in the 2010 USVI 303(d) list for water quality impairments—turbidity, dissolved oxygen, and bacteria were the primary parameters of concern listed (Figure 2). USVI DPNR and US EPA are in the early stages of developing TMDLs for three of these areas: Tamarind Reef/Southgate Lagoon, Green Cay/Chenay Bay, and Green Cay/offshore. Reported sources of pollutant loads include the marina and vessel discharges, wastewater discharges, and watershed erosion and sedimentation.

Figure 1. St. Croix East End Watersheds and Marine Park Boundaries

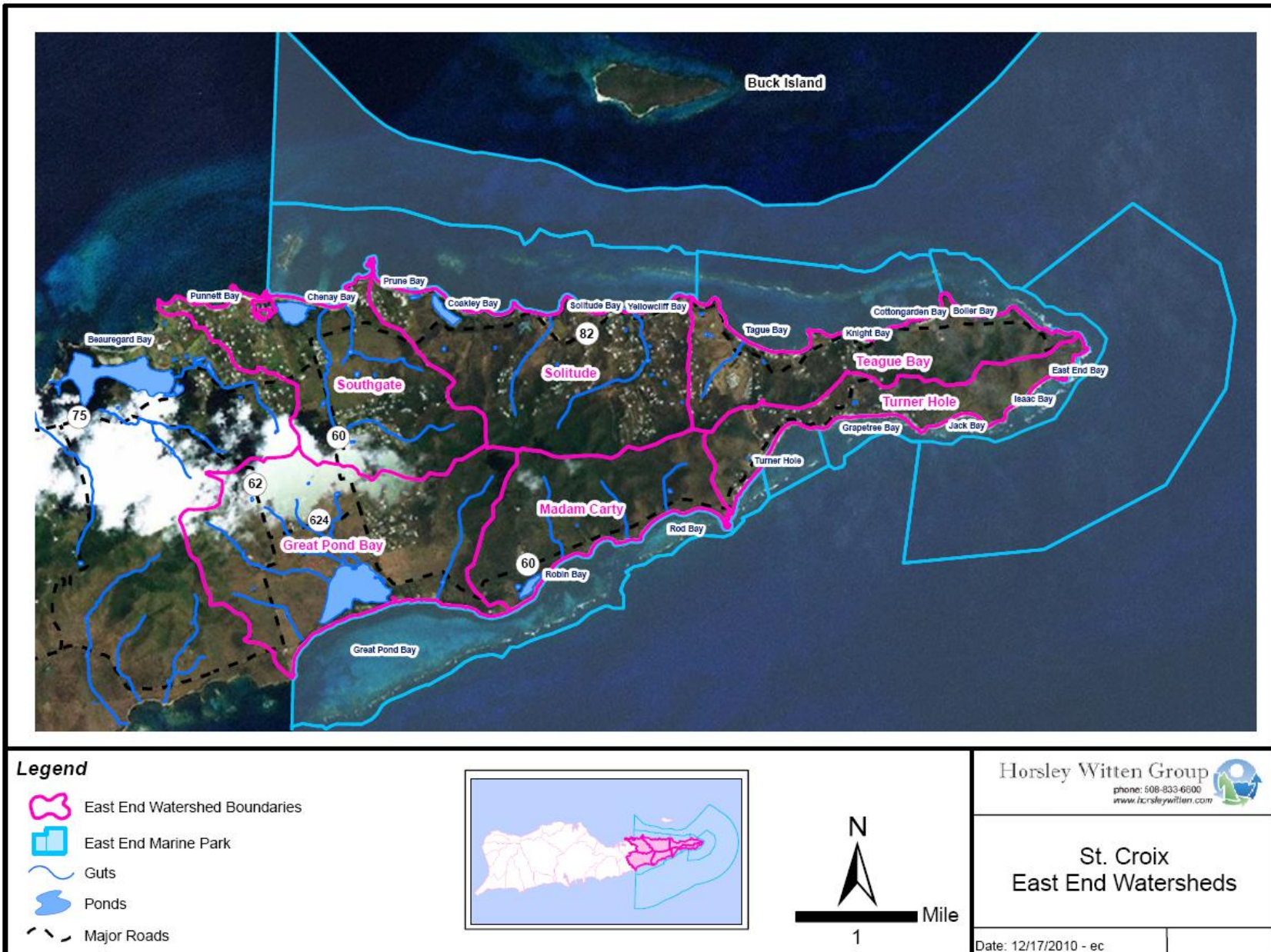

Figure 2. Location of 2010 DPNR Listed Impaired Waters around the East End

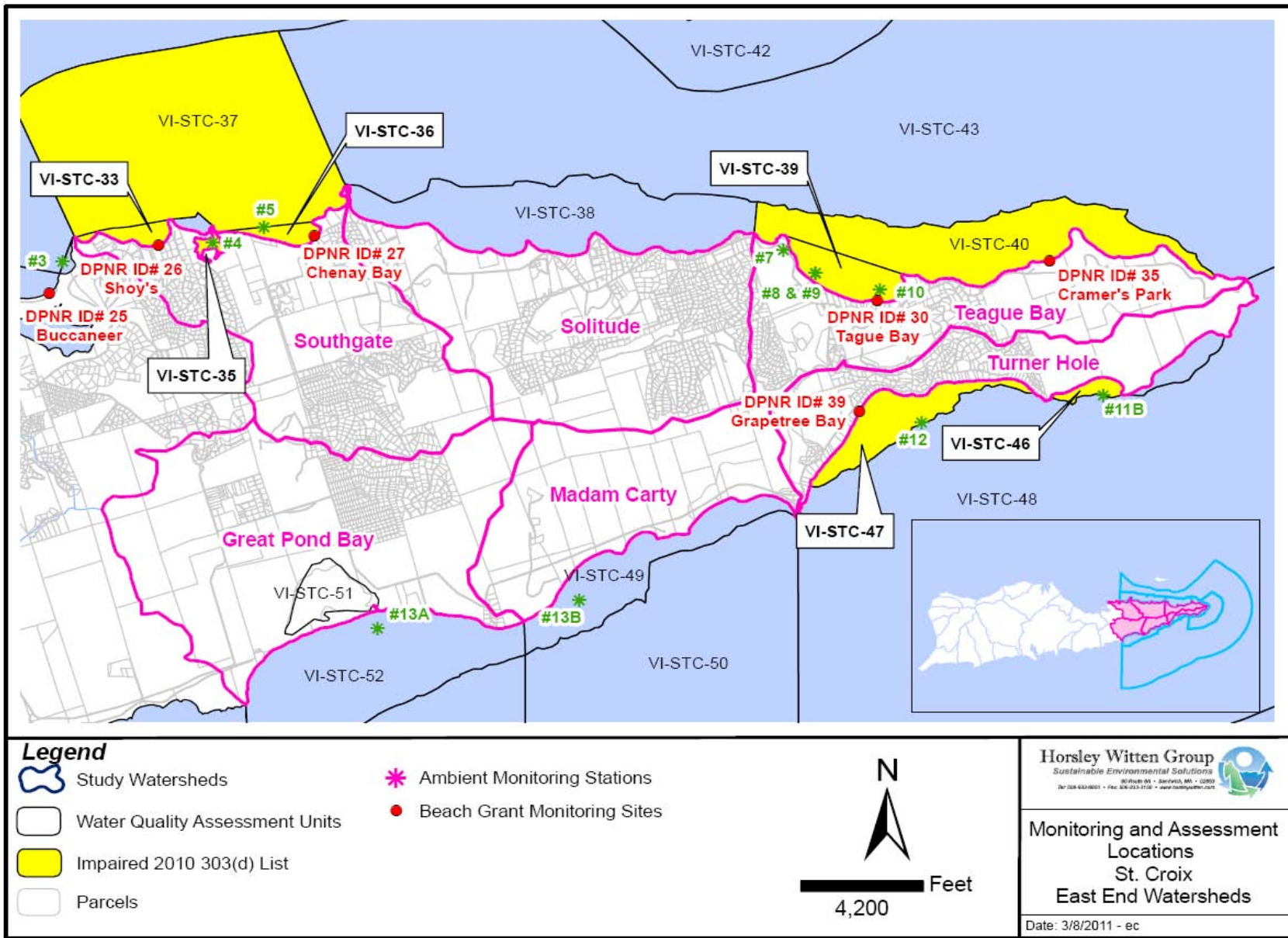

Table 1. Land Use Statistics for the East End Watersheds

Metric	Great Pond Bay	Madam Carty	Solitude Bay	Southgate	Teague Bay	Turner Hole	Total East End
Total Area (acres)	1,996	1,037	1,635	1,392	1,017	696	7,772
% Impervious Cover	3	1	9	9	8	10	7
Paved/Unpaved Road (Miles)	11.8/4.5	2.6/1.5	14.6/12.4	16.4/4.2	10.4/6.6	7.0/3.6	62.8/32.8
Gut (miles)	5.5	1.9	4.9	3.8	0.8	0.3	13.1
% Land Use Breakdown*							
Undeveloped	55	>99	50	50	44	66	59
Parks/Open Space	1				34	10	5
Agriculture	29		18	24	6		16
Public Facilities	<1				1		<1
Residential	9	<1	31	23	14	20	17
Hotel/Resort			2	1		4	<1
Marina/Waterfront					1		<1
Open Water	5			2%			<1
*Data based on 2003 UVI/DPNR mapping data							

1.2 Pollutant Loading from the East End Watersheds

Across the USVI, unpaved roads, exposed soils, and unstable guts are highly susceptible to erosion and are significant contributors to sediment deposition in ponds and nearshore waters. Uncontrolled runoff from impervious surfaces, turf areas, and agricultural lands, as well as illegal dumping and wastewater discharges (i.e., from septic systems, treatment plants, sewer leaks, and boats) are known sources of nutrients, bacteria, oils, and other toxics and can cause beach closures and trigger health advisories. There is concern that these pollutants can lead to biological impairments within the STXEEMP resulting from smothering of coral reefs, increased turbidity, excessive algal growth, reduced dissolved oxygen, and disease.

The Watershed Treatment Model (WTM) was used to quantify the impact of LBSP under existing conditions and to determine how future land development and restoration activities may affect pollutant loads in the East End. The model relies primarily on assumed stormwater pollutant concentrations and loading rates assigned to land use categories, as well as on estimated contributions from secondary sources (e.g., gut erosion, septic systems, package wastewater plant discharges, and livestock). Default pollutant concentrations and loading rates were adjusted to better reflect territorial land use categories and to account for high erosion potential areas and unpaved roads.

Relative loads for Total Suspended Solids (TSS), Total Nitrogen (TN), Total Phosphorus (TP), and fecal coliform (FC) were evaluated under existing and future conditions as follows:

- **Existing Conditions:** Total loads from each watershed were used to compare which watersheds are likely to contribute the most pollutants to the STXEEMP. Load allocations from various LBSP within each watershed were generated to identify which pollution sources are the most significant; and
- **Future Conditions:** Increase loads were estimated given proposed development projects to illustrate the impact future development may have on pollutant loading. Load reductions potentially achievable through the implementation of restoration options were estimated to quantify the benefits of implementing retrofit, road improvement, and gut restoration projects.

Results of the analysis are summarized below. Refer to **Appendix A** for more detail on the WTM and on the specific assumptions used.

1.2.1 Existing Pollutant Load Estimates

Figure 2 presents the resulting relative load contributions for TSS, TN, TP, and FC from each of the six watersheds as a percentage of the total contribution to the STXEEMP. According to model results, Solitude Bay and Southgate watersheds contribute the largest percentage of TSS to the STXEEMP. This should be expected given: 1) that they have the most acres of impervious cover in the East End, and next to Great Pond, the largest drainage areas; 2) that Solitude Bay has the most number of unpaved road miles (and highest TSS load per acre); and 3) that significant gut erosion problems have been observed in Southgate. These two watersheds are also likely to generate the most bacteria given that they have the highest percentage of residential development. Madam Carty, the most undeveloped/non-agricultural watershed of the group, expectantly has the lowest estimated contribution to STXEEMP pollutant loading. Great Pond, has the largest total drainage area of all the watersheds, which drives the pollutant contributions estimated, which are perhaps larger than expected given the flat terrain and limited urbanization.

As modeled, the sources of TSS and TN from all six watersheds include: natural background loads from undeveloped lands (aka “Forest”); rural areas such as agriculture, parks, and open space); urban land use (including unpaved roads); and secondary sources (i.e., gut erosion, wastewater discharges, marinas, and livestock). Undeveloped areas account for almost 60% of the total watershed land use, the remaining is almost evenly divided between open space/agriculture and urbanized land.

Figure 3 illustrates the estimated load allocation from each of the sources for TSS and TN for the East End. A similar breakdown of the load allocations for TSS and TN within each of the individual watersheds is presented in **Section 5.0**. The model results indicate that just under a quarter of the TSS and TN loads to STXEEMP are generated by runoff from undeveloped

areas, whereas urban runoff contributes 40% and 30% of the TSS and TN loads, respectively. It is worth noting that unpaved roads account for 38% of the TSS load within the urban land contribution; this equates to approximately 15% of the overall TSS load to STXEEMP. Septic systems and discharges from six wastewater package plants contribute to just under a third of the TN load.

Figure 2. Existing Pollutant Load Contributions to the STXEEMP (Relative Watershed Comparison)

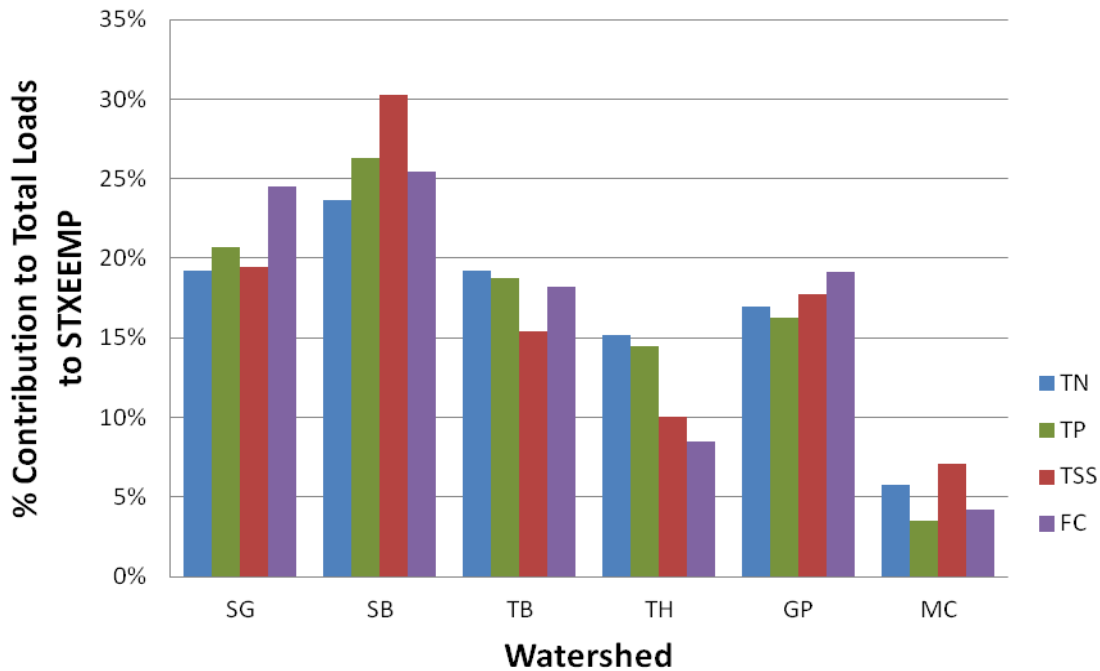
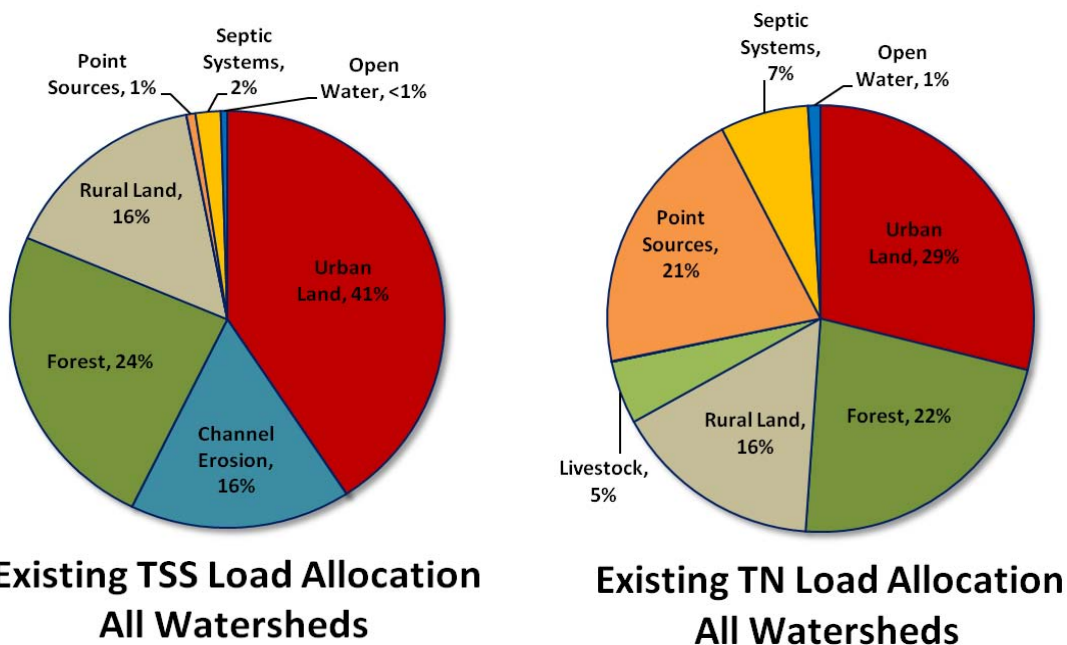

Figure 3. Load Allocations of TSS and TN from Various Sources across the East End



1.2.2 Future Load Additions and Potential Load Reductions

While there is much potential for increased residential development on the East End, estimated changes in future loads were limited to the addition of two proposed resort/casino developments in Great Pond Bay and Madam Carty watersheds. To model the addition of the Wyndham in Great Pond Bay required a conversion of 25 existing agricultural acres to hotel/resort conditions, and an assumption that stormwater management practices would be limited. For Robin Bay, 50 currently undeveloped acres were converted to hotel/resort land use, and it was assumed that a stormwater management would be maximized. Both developments were assumed to install a small package wastewater plants similar to Divi's existing wastewater treatment system. Model results indicate a significant increase in pollutant loads relative to existing conditions in the two watersheds (Table 3), particularly in the Madam Carty watershed. Increase loads shown here do not necessarily equate to water quality impairments, since absolute values are not provided.

Table 3. Percent Increase in Future Total Watershed Load over Existing Conditions

Watershed	TN	TP	TSS	FC
Great Pond Bay	88%	83%	4%	3%
Madam Carty	263%	391%	4%	20%

The implementation of future restoration practices can have a mitigating effect on pollutant loads. Each watershed was evaluated under one or more restoration scenario based on actual opportunities that were identified in the field including:

- Construction of all stormwater retrofits in the watershed;
- Implementation of all recommended unpaved road improvement projects;
- Wide-scale stabilization of all unpaved roads; and
- Completion of recommended gut stabilization practices.

Road stabilization projects were modeled by changing unpaved road TSS event mean concentrations to paved concentrations, which are lower. Stormwater retrofits were modeled using default pollutant removal efficiencies at a 75% capture rate.

Table 4 summarizes the relative TSS load reduction over existing conditions within each watershed based on the implementation scenarios.

The model has the capacity to quantify non-structural practices as well (e.g., enhanced erosion control enforcement, fertilizer reductions, street sweeping, and education programs), but these non-structural practices were not incorporated into this analysis.

Table 4. Potential Percent Reduction in Total TSS Load Over Existing Loads

Watershed	Scenario	Assumptions	% TSS Reduction in Watershed*
Great Pond	Stabilization of <u>all</u> unpaved roads	<ul style="list-style-type: none"> Unpaved roads account for 24% of existing TSS load from urban areas There are 10.4 acres of existing unpaved road surface Only 1 identified road project so not modeled 	5% from total load
	Gut restoration	Two small projects identified, but most gut miles assumed stable; not modeled.	
	Stormwater Retrofits	None identified	
Madam Carty	Stabilization of <u>all</u> unpaved roads	Unpaved roads account for 56% of existing urban watershed TSS load	80% total load
	No specific restoration projects identified		
Solitude Bay	Stabilization of <u>all</u> unpaved roads	<ul style="list-style-type: none"> Unpaved roads account for 50% of the total TSS load from urban land in watershed There are 40 acres of total unpaved roads 	27% total load
	Only identified road projects	<ul style="list-style-type: none"> Total 10 acres Split stabilization evenly between high/low erosion potential areas 	7% total load
	Stormwater retrofits	<ul style="list-style-type: none"> Implementation of 7 bioretention/rain gardens; 1 constructed wetland; and 4 proposed swales 98 drainage acres with 19 acres of impervious cover 	<ul style="list-style-type: none"> 5% total load 10% from urban contribution
Southgate	Identified gut restoration	<ul style="list-style-type: none"> Existing gut erosion accounts for 25% of watershed storm load Two significant gut stabilization projects totaling 0.3 miles reduce gut erosion to less than 10% of total storm load 	17% total load
	Stormwater Retrofits	<ul style="list-style-type: none"> Implementation of 6 bioretention/rain gardens, and 2 swale systems, and 2 oil/grit separators 12 drainage acres with 4.5 acres of impervious cover 	<ul style="list-style-type: none"> 1% from total load 3% from urban contribution
	Road stabilization	Not modeled since there were no identified road projects and only 18% of existing urban load is associated with unpaved roads	
Teague Bay	Stabilization of <u>all</u> unpaved roads	<ul style="list-style-type: none"> Unpaved roads account for 48% of existing TSS load from urban areas There are 14.7 acres of existing road surface Two identified projects of < 1 acre 	20% total load
	Stormwater Retrofits	<ul style="list-style-type: none"> Implementation of 1 bioretention/ rain gardens, 1 pond, and 2 wetlands 12 drainage acres with 4.5 impervious acres 	<ul style="list-style-type: none"> 3% total load 7% from urban contribution
	Gut restoration	One site identified. Not modeled.	
Turner Hole	Stabilization of <u>all</u> unpaved roads	<ul style="list-style-type: none"> Unpaved roads account for 25% of existing TSS load from urban areas There are 6.2 acres of existing road surface No specific repair projects were identified (except for a small part of Ridge Rd. at Divi) 	11% total load
	Stormwater Retrofits	<ul style="list-style-type: none"> Retrofit of 3 existing detention basins 6 bioretention/rain gardens, and 1 permeable pavement 89 drainage acres with 34 impervious acres 	<ul style="list-style-type: none"> 10% total load 21% from urban contribution
	Gut restoration	None identified	

* TSS Reductions from existing conditions are independent of other restoration activities and are not cumulative.

1.2.3 Implications for Watershed Management

Implications of these results on the overall watershed management strategy may include (in no particular order):

- Prioritizing restoration efforts in Solitude Bay and Southgate watersheds since they contribute the largest percentage of TSS and TN loads;
- Recognizing that significant increases in watershed loads may result from new development; therefore, prioritizing regulatory and programmatic actions to minimize the impact of new development is critical;
- Stabilizing unpaved roads provides the highest TSS load reduction potential of the options modeled. Unpaved roads are a significant component of the urban TSS load and stabilization of these areas should be a priority for watershed management;
- Preventing gut erosion can also result in significant load reductions; however the overall contribution of gut erosion to the TSS load is not well understood. A gut morphology study across the USVI may be necessary to more accurately estimate the load reduction benefit of stabilization projects;
- Retrofitting is limited given the few number of sites identified and the undeveloped nature of the East End. Cistern use in the East End helps reduce a portion of the stormwater load, though modeling does not account for this particularly well. Turner Hole had the highest load reduction potential associated with retrofits than the other watersheds, likely due to the presence of existing detention basins in need of retrofit and maintenance;
- Modeling indicates that wastewater and septic discharges may represent less than 1/3 of TN surface loads to the STXEEMP, which is almost equivalent to the estimated load from urban runoff (groundwater loads have not been accounted for here). While not as critical for TSS, reducing wastewater nutrient loads may be important for reducing overall nutrient loading, particularly since high nitrogen loading to groundwater has been reported;
- Recognizing that given the large percentage of undeveloped areas, absolute loads from the East End may not be significantly higher than natural conditions, particularly when compared to other parts of the USVI; and
- Understanding that the strength of the model is only as good as the input data. As better information becomes available (e.g., more accurate land use maps, locally-derived pollutant concentrations or loading rates, reliable water quality data), the model should be revised.

1.3 Purpose of the Plan

The USVI Department of Planning and Natural Resources (DPNR), the USDA Natural Resource Conservation Service (NRCS), St. Croix Environmental Association (SEA), The Nature Conservancy (TNC), the Horsley Witten Group, Inc. (HW), and dozens of local stakeholders have spent the last year assessing watershed conditions, discussing restoration opportunities, and developing a recommended approach to reduce the impact of LBSP on the STXEEMP. This report is written primarily for the East End Marine Park and other DPNR staff; however there are a wide range of stakeholders including federal and territorial agencies, non-government organizations, and individual businesses and residents with an interest in the East End who will be critical partners in advancing implementation.

The purpose of this watershed plan is to:

- Outline overarching goals and management recommendations to reduce LBSP in the six watersheds draining to the STXEEMP (**Section 2.0**);
- Describe recommended structural restoration projects, such as stormwater retrofits, gut and pond restoration, road stabilization, and drainage improvements (**Section 3.0**);
- Discuss key non-structural activities such as pollution prevention, programmatic and regulatory improvements, and education activities (**Section 4.0**);
- Establish a preliminary implementation schedule, identify watershed specific strategies, and a proposed approach for measuring progress (**Section 5.0**).

Appended to this report are watershed management maps (**Appendix B**) and concept design summaries (developed to the approximately 10% level) for priority restoration projects (**Appendix C**). It should be noted that designs were advanced (ranging from 25-60% design) for five of these projects in order to initiate early implementation and/or provide design examples for stormwater and gut restoration challenges in other parts of the USVI. These design plans can be downloaded from the project website at www.horsleywitten.com/stx-east-end-watersheds/index.html.

In addition, this report is supplemented by an *Existing Watersheds Conditions Report* (dated April 2011) that summarizes baseline information on East End watershed conditions (i.e., land use, precipitation, soils, impaired waters, regulations, etc). The *Existing Conditions Report* also includes a detailed summary of field findings and brief descriptions of existing and proposed conditions at each site investigated, and a preliminary ranking of candidate projects. Subsequent efforts to estimate pollutant loads and conduct a more formal project ranking process have since refined initial project ranking. As mentioned previously, **Appendix A** contains a final technical memorandum describing the methods used to estimate pollutant loads and prioritize projects. It is not the intent of this watershed plan to repeat information previously provided except where necessary to support implementation recommendations.

1.4 Caveats

The following limitations on the information presented in this report should be considered:

- Existing pollutant loads and potential reductions estimated using the WTM rely on a number of key assumptions using limited data and were not calibrated against water quality monitoring data. The model was used to estimate relative watershed loads and without additional data input, should not be used to generate reliable, absolute values. The model output presented here should not be used in lieu of a more thorough analysis to establish TMDLs. Model results are presented as load percentages to surface waters, which are collectively referred to as the STXEEMP but also include the ponds. Groundwater loads are not accounted for.
- While extensive field investigations and stakeholder meetings were conducted, the list of watershed restoration opportunities presented here should not be considered exhaustive.
- An inventory of guts, septic systems, waste water discharges, or territorial environmental regulations was not conducted as part of this effort.
- An evaluation of wetland and upland habitat restoration needs was not conducted as part of this effort; however, existing ecological inventories and conservation efforts by SEA, TNC, and NPS are assumed to fill this gap.
- Project ranking is intended to inform the implementation process; actual implementation frequently occurs as other opportunities arise and the ranking should not be viewed as an absolute sequence for implementation.
- Concept designs offer one option for restoration based on limited field assessment and available GIS, but may not be the most feasible or most cost-effective solution possible. Load reduction estimates generously assume the capacity to manage the 90th percentile of storm events at each site, which may not always be practical at every location.
- Where planning level construction costs are provided, these costs are based on a 30% increase over typical unit costs from stateside and from unit costs provided by USVI Department of Public Works.
- A watershed plan is meant to be a living document; revisions are anticipated as implementation advances, windows of opportunity are opened, local priorities change, or as more information on watershed conditions becomes available.

This page intentionally left blank.



2.0 Goals & Management Recommendations

The intent of this management plan is to provide implementation guidance to help environmental resource managers achieve the following goals:

1. Protect the marine resources of St. Croix's East End Marine Park from the negative impacts of land-based sources of pollution and maintain the rural character of the East End;
2. Engage local residents and businesses in watershed stewardship activities; and
3. Demonstrate restoration actions that can be applied throughout the USVI.

These goals will be met through implementation of the nine management recommendations described below:

1. Hire a watershed coordinator and establish an implementation committee to oversee short and long-term implementation of watershed recommendations. This person ideally would be housed under the East End Marine Park, although CZM's APC coordinator position could also be assigned this role. Alternatively, successful models exist around the country and in the USVI of local watershed/community groups being effective at providing these services; therefore SEA might be a realistic option as well. The watershed coordinator should work directly with an implementation committee composed of key partners with access to funding opportunities and implementation capacity (i.e., CZM, DEP, DPW, USDA, NOAA, TNC, SEA, and one or two rotating HOA representatives).

2. Enforce existing environmental regulations affecting land development procedures, including zoning requirements, drainage criteria, and erosion and sediment control. This may require improving agency notification procedures for complaints and response times to more quickly address issues. DPNR Division of Environmental Protection (DEP) should adopt stormwater quality standards for new development and redevelopment activities that require appropriate runoff reduction and/or pollutant removal and channel protection criteria for small storm events. CZM and EEMP should propose a unified wetland/gut management strategy to other agencies to clearly define no-touch buffer zones, procedures for land subdivision, permitting procedures for gut alterations, etc. These issues are particularly important for Madam Carty, Great Pond, and Southgate where new large-scale development projects have been proposed.

3. Support ongoing conservation and habitat restoration activities of NPS, TNC, and SEA. The East End is such a remarkable resource for residents and visitors. The watersheds' inextricable tie to the quality of the marine resources within the STXEEMP, as well

as other unique island habitats, is unquestionable. Avoiding impacts to these areas is of the utmost importance. Much of the East End is under conservation easement or protected as open space (e.g., TNC-owned property in Turner Hole, public park land in Teague Bay, Southgate Reserve in Southgate). These areas serve to protect remaining wetland habitats and can provide opportunities to re-establish native upland communities. Restoration activities to improve habitat conditions within these properties, as well as for sites draining to these resources, should be management priorities. Examples of existing habitat restoration efforts include native vegetation plantings in the East End Bay and restoring water levels in Southgate Pond via embankment repair. Conservation of additional buffer areas surrounding Great Pond, while seemingly improbable at this time, should actively be pursued.

4. Reduce existing sediment loads and improve public safety through road and gut stabilization projects and drainage improvements. These activities are particularly important in the Solitude and Southgate watersheds as demonstrated by pollutant load modeling, but the recommendation applies throughout the East End. These activities could be led by DPW and NRCS in concert with appropriate homeowners associations. Load reduction targets should be established for the Southgate watershed as part of the upcoming TMDL process. Given the context of flood prevention and drainage improvement across St. Croix, it seemed appropriate by HW not to establish a target road stabilization goal for non-impaired waters of the East End at this time.

5. Manage untreated stormwater runoff by retrofitting existing development that currently lack adequate stormwater management. Impervious surfaces on commercial properties, roads, and residential areas collect pollutants and generate stormwater runoff. Where feasible, runoff from parking lots should be captured and treated before it is discharged to guts and wetlands. Where small storm drainage from rooftops is not collected in cisterns for reuse, rooftop disconnection should be considered. Retrofitting will be important in Southgate, Teague Bay, and Turner Hole. Early implementation projects should provide designs for pilot projects that can be applied in other parts of the USVI.

6. Manage pollutant loads from rural lands primarily through floodplain and gut restoration; vegetation establishment; livestock management; and pond restoration. Much of the area in the East End is active and inactive agricultural area. These areas can provide opportunities to obtain potential easements in locations where stormwater detention could be improved. These activities should be led by the USDA/NRCS.

7. Implement a targeted education and public involvement plan for homeowner associations, restaurants, resorts, and marinas/yacht clubs. To better engage local residents and businesses in watershed stewardship activities, educational messages should be delivered to the appropriate audience in a non-threatening manner. Key messages include how to improve individual wastewater management, inexpensive pollution prevention activities, and effective road maintenance practices. There are a number of agency and non-government

sponsored educational initiatives on St. Croix that watershed messaging could be linked into; SEA would make an excellent stewardship advocate.

8. Integrate watershed restoration efforts with existing agency programs such as DPW’s capital improvement project planning; DPNR and EPA’s TMDL process; DPNR’s comprehensive planning updates, NOAA’s coral reef protection strategies, USDA farm improvement goals, and others to secure long-term funding for watershed management project installation and maintenance.

9. Establish a formal mechanism for tracking progress and results, particularly for priority projects and programmatic activities. The University of the Virgin Islands engages in a number of monitoring activities in the East End and could provide a good forum for hosting annual watershed progress meetings.

This page intentionally left blank.



3.0 Structural Practices

To address management **recommendations #4, #5, and #6**, a number of opportunities to reduce sources of pollution were field-identified including stormwater retrofits, stabilization of actively eroding guts, unpaved road improvements, and culvert repair and replacement. These types of projects and recommended approaches to implementation are described below in more detail. The prioritization of candidate projects is also presented here; more information on the project ranking process can be found in **Appendix A**. Watershed maps showing the locations of priority projects are located in **Appendix B**. Concept sketches for high priority sites can be found in **Appendix C**.

3.1 Stormwater Retrofits

Urban runoff accounts for over 40% and 30% of the total East End TSS and TN load, respectively, and there are over 500 impervious acres currently mapped in the East End. Retrofitting involves going back into existing developed areas and installing new, or improving existing, stormwater management facilities in order to improve water quality treatment and/or reduce runoff volumes to better match pre-development site conditions. With the exception of three existing detention basins associated with Divi Resort/Casino and the Villa Madeline, urban stormwater runoff is largely unmanaged in the East End (Figure 3).

Despite recent efforts to strengthen the USVI TPDES permit system, there are no standardized treatment criteria to require adequate management of stormwater from new development. Most parking lots do not have formal drainage systems; therefore, the road network becomes the defacto drainage system that conveys large volumes of contaminated runoff to guts and wetlands. Since the East End does not have a public water supply, the majority of the rooftops drain to cistern collection systems, which reduces the total volume of surface stormwater runoff, at least for small storms, which lessens the typical rainfall/runoff relationship associated with total impervious cover.

Modeling predicts that implementation of the retrofits identified here can potentially **reduce the total urban TSS load in Solitude Bay by 10%, 3% in Southgate, 7% in Teague bay, and 21% in Turner Hole**. However, not all projects as conceptualized will be feasible given budgetary and other site constraints. Ranking helps to identify those projects that, perhaps, make the most sense in terms of cost/benefit; although actual implementation will be more closely linked to real opportunities and not necessarily the scoring matrix. At this early stage in management of stormwater in the USVI, there are a number of competing priorities that make absolute project prioritization difficult. Therefore, this list of projects should be kept in mind as grant funding becomes available, capital improvements are planned, and redevelopment or property improvements are made.

Figure 3. Existing Detention Basins in Turner Hole at Divi



Table 5 lists **35 individual retrofit opportunities** identified during the watershed assessment. The retrofits identified here include structural control practices preliminarily identified as bioretention, rain gardens, wet ponds, constructed wetlands, swales (dry and bioswales), regenerative conveyance, permeable pavement, and oil/grit separators. In some cases, multiple retrofit projects were identified on single properties. These projects were ranked using 11 criteria related to water quality benefits, other public benefits, relative cost, management feasibility, and site constraints. Detailed ranking methodology and scoring results can be found in **Appendix A**. Arguably, the restoration of farm ponds and other man-made detention structures (i.e., golf water features) may also fall into the stormwater retrofitting bin. Though not thoroughly investigated under this watershed planning effort, there are over 35 mapped small ponds in the East End, and their potential to reduce sediment loads from both undeveloped and developed areas is currently unknown.

Figure 4 illustrates an example of where rain garden and bioswale retrofits could be installed at the Cheney Bay Resort in the Southgate watershed. The locations and conceptual sketches for these projects can be found in **Appendix B** and **C**, respectively. In addition, a narrative discussion of site conditions and copies of individual field forms can be found in the *Existing Condition Report*. More detailed designs are available for retrofit concepts at the Divi Casino, Reef Golf, Fire Station, and East End Bay Trail on the watershed website at <http://www.horsleywitten.com/stx-east-end-watersheds/designs.html>.

Table 5. Priority Stormwater Retrofit Projects

Site ID*	Location	Description	Total Score	Priority
TH-R-2A	Divi Casino	retrofit existing dry detention basin	40	High
TB-R-3B	Reef Golf Course	constructed wetland/forebay	39	
TB-R-3A	Reef Golf Course	wet pond	38	
SG-R-20A	Chenay Bay	rain garden at restaurant	37	
SB-R-1B	Fire Station	dry swale, cistern, and covered dumpster area	37	
TH-R-1	East End Bay Trail	bioretention at parking lot	36	
SB-R-3	Seven Flags	stepped regenerative conveyance system	35	
TB-R-2B	STX Yacht Club	rain garden	35	
SB-R-1A	Fire Station	rain garden in front	35	
TH-R-3A	Divi Hotel/Resort	retrofit existing dry detention basin	35	
TH-R-3B	Divi Hotel/Resort	rain garden in parking lot	32	
TH-R-3D	Divi Hotel/Resort	rain garden in parking lot	32	
TB-R-2A	STX Yacht Club	constructed wetland forebay & formalized swale	32	
SG-R-5	Tamarind Reef	shallow bioretention near tennis courts	32	
TH-R-5	Villa Madeline	maintenance & expansion of existing detention	31	
SG-R-2A	Southgate Condos	rain garden at Entrance	31	
SG-R-4	Green Cay Marina	swales in roadside median	31	
TH-R-4	Hotel Renovation	bioretention in parking lot	30	
TH-R-2C	Divi Casino	landscape island rain garden in Divi parking lot	30	
TH-R-2B	Divi Casino	landscape island rain garden in Divi parking lot	30	
SG-R-20B	Chenay Bay	linear bioretention in parking lot	30	Low
SG-R-3B	Green Cay Marina	bioretention	30	
TB-R-4	Skov Farm	Pond restoration & upland drainage stabilization	--	
SB-R-6	Coakley Bay Condos	roadside swale in front of Coakley Bay Condos	28	
TH-R-3C	Divi Hotel/Resort	permeable pavement in parking lot	28	
SG-R-1	Cheeseburgers	Bioswale or rain garden	27	
SB-R-7	Carden Beach	shallow constructed wetland	26	
SB-R-7A	Carden Beach	cul-de-sac bioretention, forebay maintenance, and outlet stabilization	25	
SB-R-4	Ziggy's	Swale or perimeter filter	25	
SG-R-2B	Southgate Condos	bioretention in rear to collect parking/drive aisle	25	
SB-R-5A	Coakley Bay Condos	Bioretention in existing pervious area	23	
SB-R-5B	Coakley Bay Condos	Bioretention to capture parking lot/drive aisle	23	
SB-R-2A	Blue Water Terrace	Bioretention for parking lot drainage	23	
SB-R-2B	Blue Water Terrace	bioretention for parking lot drainage	23	
SB-R-8	Candle Reef II	cul-de-sac island bioretention	22	
SG-R-3A	Green Cay Marina	oil/grit separator	20	
SG-R-3C	Green Cay Marina	oil/grit separator	20	

* Site ID's correspond to mapping labels in Appendix B and are coded as follows: SG= Southgate, SB=Solitude Bay, TH=Turner Hole, and TB=Teague Bay; Yellow highlighting indicates projects with more detailed design plans.

Figure 4. Example Locations for Retrofits to Capture Rooftop and Parking Drainage

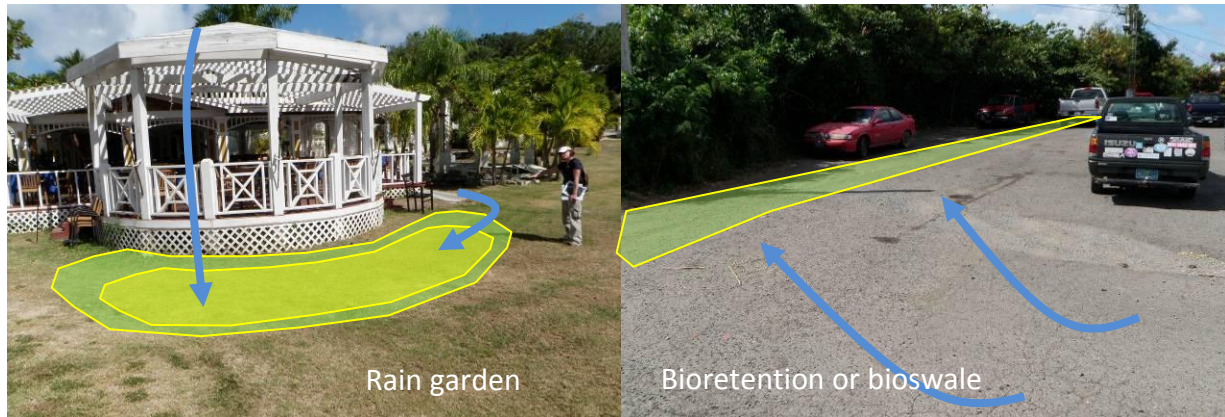

Retrofitting in the East End can be difficult given the following challenges:

- High groundwater tables and soils with poor infiltration capacity, which is often the preferred approach to managing surface runoff;
- Lack of publicly-owned parcels, easements, and road rights-of-way where retrofits can be placed;
- Lack of a regulatory mandate or incentives for owners to improve the quality of stormwater discharges from private properties;
- Limited understanding of gut capacity to handle stormwater discharges (e.g., infiltration capacity, channel stability, etc);
- Few existing examples of effective stormwater facilities or successful retrofit projects;
- Lack of adequately-sized public drainage infrastructure to tie private facilities into;
- High material and labor costs for construction; and
- Lack of incentive to manage private small events given the magnitude and frequency of larger storms.

We recommend that some of the following short-term actions be completed in implementation years 1 through 5:

Retrofit Action 1: Identify three or four early action projects that can be installed quickly, are highly visible, can serve as demonstration projects, and generate support for future efforts. These typically include small projects, such as rain gardens that can involve volunteers and utilize donated materials. The East End Bay trail head, fire station, Chenay Bay Resort, and St. Croix Yacht Club may provide such an opportunity. Revisit concepts at Cheeseburgers and Bluewater Terrace to see if simple raingardens could substitute for bioretention and bioswale options.

Retrofit Action 2: Approach Divi and Villa Madeline about maintenance issues and possibility of improving treatment capacity of existing facilities. Conversion of dry detention basins to water quality practices tends to be relatively inexpensive per acre treated and can provide an example for how facilities should be constructed in the future. Simple modification of the existing outlet structures, extension of the flow path, and planting of vegetation can significantly improve treatment efficiency of existing detention basins. It would be helpful to verify if these practices could be expanded to better manage the drainage coming to them.

Retrofit Action 3: For big projects, secure funding in the short-term to advance the first phase of stormwater retrofitting which includes site surveys, 30-60% engineering design, and permitting. This will help in determining not only how much a project will cost, but if permitting issues prevent the project from moving forward (such as the constructed wetland at Reef Golf).

Retrofit Action 4: Coordinate a meeting/site tour, or dedicate the next Non-Point Source Conference hosted by DPNR to convene project managers and contractors around the USVI with retrofitting experience. Unlike state-side, there are few examples of how these practices should be designed, installed, and maintained here on the island. UVI, NRCS, and Coral Bay Community Council have a number of raingarden, road stabilization, and gut restoration projects under their belt, which can help with design, cost estimates, and picking the right contractor. This meeting should also be used to establish cost estimates for retrofit projects and to draft stormwater management criteria that can be incorporated into a new, enforceable, stormwater design manual for the USVI.

Retrofit Action 5: Establish a stormwater practice database in GIS to track existing BMPs and retrofit projects. This database should include type of facility, date of construction, drainage area captured and treated, design and construction costs, and any maintenance records. This mapping and tracking information should become an integral component of the TPDES program.

Retrofit Action 6: Secure funding for construction. When funding opportunities arise, capital improvements are planned, and redevelopment or property improvements are made, turn to your retrofit list to see what projects are ready to move forward.

Retrofit Action 7: Conduct a survey of small manmade ponds in the East End to determine condition, drainage area, and estimated rate of sediment deposition. These ponds detain runoff, retain sediment, and provide drinking water for livestock; however, the influence of these small impoundments on the overall water or sediment budget has not been documented recently. Existing farm ponds that require maintenance including vegetation management, sediment removal and structural repair (e.g., liners, spillway systems, etc.) should be prioritized for USDA grant monies, which could be viable when coupled with gut restoration, buffer reforestation, and other best management practices.

Important tips for successful retrofitting in the East End include the following:

- Consider the type of vegetation to be used in rain gardens, bioretention, and other vegetated practices. Plan for watering, if necessary, to establish growth since there is no public water supply. A multi-phased approach to retrofit construction can allow for planting of vegetation during wetter seasons.
- When pricing, include a contingency line item in construction budgets ranging anywhere from 10-30%.
- Do not forget about erosion and sediment control, particularly temporary stabilization practices during retrofit construction, if necessary.
- Do not pursue retrofit activities without a good understanding of the short and long-term maintenance requirements and who is going to be responsible for them.
- Refine pollutant load reduction estimates for each project as actual drainage areas are defined, flows are modeled, and designs become finalized and if performance monitoring is conducted.

3.2 Gut Stabilization and Buffer Enhancement

There are over 13 miles of mapped guts in the East End. Recent studies in the Chesapeake Bay have shown that in-stream erosion can contribute twice as much sediment as upland sources (2/3 of the total watershed TSS load) where watershed runoff volumes are high (Medina and Curtis, 2011). While the dry guts on the East End differ significantly from urban streams in the Chesapeake Bay study, no data has been published to evaluate TSS loading from gut erosion in the USVI or to suggest that gut erosion is insignificant. In fact, the comprehensive study of gut ecology and morphology is in its infancy in the USVI, and many questions still exist regarding the role guts play in stormwater conveyance, the impact of small vs. large storm events on gut stability, and their infiltration capacity. While some of these questions are being investigated in priority guts across the USVI, none of the guts in the East End are part of these studies.

This watershed planning effort did not include an investigation of gut or riparian buffer condition; although road crossings and widely-known gut erosion locations were evaluated by the project team. Modeling assumptions included best professional judgment on the contribution of guts to overall TSS loads and the reduction potential from gut stabilization projects were all based on limited field observations that were made. Table 6 lists six gut restoration projects that were identified during the watershed assessment. These projects were ranked similarly to the retrofit projects, but overall length of stabilization area was compared (see Appendix A for the ranking details).

Table 6. Priority Gut Restoration Projects

Site ID*	Location	Description	Total Score	Priority
SG-G-2	East Gut Adams Farm headcut	Stabilize headcut and overland flow path; plant buffer vegetation; provide stabilize crossing pad	45	High
TB-G-1	Gut at Reef Golf Course	Divert small storms to pond; stabilize eroding banks; check dams to slow erosive velocities; replace culvert	40	High
GP-G-1	Sally's Fancy-West Gut	Install curb and paved flume to direct flows into riprap stabilization at head cut; investigate buffer enhancement	31	Medium
GP-G-2	Sally's Fancy-East Gut	Address pond breach; remove sediment stockpile in gut	30	Medium
SG-G-1	West Gut behind Cheeseburgers	Isolated bank stabilization	21	Low
SG-G-3/ SG-RC-22	West Gut on Schuster's property	Existing NCSU restoration proposal for lower gut section; address headcut at top by stabilizing road drainage and outlet location	23	Low
*Site ID corresponds to locations on watershed maps and to candidate project field form ID's				

Load reductions based on gut restoration were only modeled for Southgate due to the severity of gut erosion problems observed in that particular watershed, and because few projects were identified in the other watersheds. The model estimated that a 17% TSS reduction could be achieved from gut restoration projects in Southgate, assuming that initial TSS loads contribute a quarter of the total watershed TSS load initially. More effort to better understand erosion rates and sediment transport will be required to better quantify actual reductions. Figure 6 shows the perimeter of a massive headcut (recorded with GPS unit in July 2011) on the Adams Farm property overlain on top of 2007 aerial imagery. It appears that the headcut has migrated approximately 40 ft since the aerial image was taken. Assuming the average depth of the headcut is 10.6 ft, the volume change over the four-year period is approximately 485 cubic yards (13,086 cubic feet).

We recommend some of the following short-term actions to be completed in implementation years 1 through 5:

Gut Restoration Action 1: Advance engineering design plans for addressing priority gut stabilization projects, including Adams' Farm and Reef Golf Course. These designs should be compared with other gut restoration concepts proposed throughout the USVI to generate a menu of restoration options.

Gut Restoration Action 2: Meet with DPNR, Fish and Wildlife, NRCS, UVI, TEMA, Army Corps of Engineers, and others to discuss the permitting requirements for (and other

implications of gut restoration activities that may involve the in-stream placement of structures (e.g., check dams and detention features) or floodplain reconnection.

Gut Restoration Action 3: Work closely with USDA, NOAA, DOT, and other federal partners to secure restoration funds to implement big gut restoration projects. Work with DPW to stabilize headcuts and eroding banks adjacent to roadways as part of public road and culvert maintenance projects.

Gut Restoration Action 4: Use a combination of GIS and field investigation to characterize in-stream and riparian gut conditions. Guts should be classified according to drainage area, bank stability, number of road crossings, number of outfalls (or stormwater discharge points into gut) number of impoundments, and natural buffer width. This data should be used to help inform managers of the effectiveness of gut/buffer protection regulations, improve mapping accuracy, and establish baseline monitoring stations for long-term data collection on flow and water quality, channel dimensions, and biological communities.

Figure 6. Forty-foot Headcut Migration of Adams' Family Gut over Four Years



3.3 Unpaved Road Stabilization

Unpaved roads have the potential to be one of the most significant sources of sediment loading in the East End (Figure 7). Modeling indicates that **38% of the urban TSS loading to the East End is from unpaved roads**. This estimate is likely conservative given the sediment production rates measured by Ramos-Scharron and other researchers in the USVI and in Puerto Rico. There are a number of privately-owned roads and residential streets that should be high priorities for repair, paving, or other drainage improvements. The DPW does not extend maintenance authority to most of the private roads; therefore, watershed managers and homeowner associations will likely have to play a large role in securing funding for any road improvement project.

Table 7 lists six unpaved road stabilization projects identified during field investigations. These projects were ranked based on the severity of the problem, including the length of area to be stabilized and the relation to impaired waters, vehicular demand, crossover with DPW priorities, and strong homeowner association awareness.

Figure 7. Priority Unpaved Road Projects in Seven Flags and Hope and Carton Hill Areas



Similarly, there are a number of small, eroding, pedestrian trails that are candidates for stabilization, particularly ones where access is not limited to pedestrian traffic. The recent East End Bay Trail stabilization project is an example of the conversion, relocation, and stabilization of a trail system using boulders to prevent vehicular access, check dams to reduce erosive velocities, stabilized outlet structures to convey runoff safely down slopes, using small sediment forebays, waterbars, and vegetative stabilization using grasses. Some trailheads will require the diversion of stormwater runoff away from the trail, stone or timber steps, and waterbars and other cross-drain features. The Nature Conservancy is responsible for managing an extensive

trail system at the East End, and has employed a number of innovative practices to prevent trail erosion. Table 8 includes a summary of trail restoration sites identified during field investigations, though we suspect there a number of additional locations where trail stabilization is needed.

Table 7. Priority Road Stabilization Projects

Site ID*	Location	Description	Total Score	Priority
SB-RC-9	Seven Flags Rd.	Pave 1000 ft/ (0.5 acres) section of road with severe ditch erosion that is threatening existing buildings and clogging public culvert; redirect flows into gut and pipe overflow to new culvert to be installed under East End Rd.	17	High
TB-RC-3	Ridge Rd. at Rt. 82	Install waterbars to stabilize 250 ft (.1 acres) of unpaved road section	17	
SB-RC-8	Hope and Carton Neighborhood	3.6 miles (8.7 acres). Develop master drainage plan for neighborhood road network to prevent deposition into gut at Pony Club Trail Rd.	16	
TB-RC-4	Goat Hill Rd.	Stabilize 1200 ft (0.6 acres) section with waterbars	16	
GP-RC-33	Unnamed Road off South Shore	Stabilize 300 ft (0.1 acres) section with waterbars	13	Medium
SB-RC-1	Sierra Verde/Bajamar Rd	Stabilize 350 ft (0.2 acres) section with waterbars	8	Low
*Site ID corresponds to locations on watershed maps and to candidate project field form ID's				

Table 8. Trail Stabilization Projects

Site ID*	Location	Description
TB-R-1	Off of East End Bay Rd. at Cotton Garden Pt.	Install guardrail to prevent vehicular access
GP-R-3	East End Marine Park Office	Stabilize privately-owned trail to beach from open field area near East End Marine Park Office; may involve formalizing parking area and incorporating into proposed campground development project.
SB-R-6	Trail below Coakley Bay Condos	Stabilize public access to beach that takes runoff from condos and roads
TH-R-1	East End Bay Trailhead	Retrofit to manage runoff from new parking lot and roadway
*Site ID corresponds to locations on watershed maps and to candidate project field form ID's		

We recommend some of the following actions be completed as practical in implementation years 1 through 5:

Unpaved Roads Action 1: Coordinate with The Nature Conservancy to install waterbars and other practices where necessary on Goat Hill Rd. This site offers a unique opportunity to test

variations on water bar design, installation methods, and maintenance activities that could serve as a model for other private roads in the East End, and is a good candidate for early implementation.

Unpaved Roads Action 2: Coordinate a one-day workshop on St. John with the Coral Bay Community Council, DPW staff, and contractors to tour existing road stabilization projects on Callabash Boom, Maho Bay, and other locations where waterbars, roadside checks, concrete dips, and outlet stabilization practices have been installed. Conduct a design charette for a priority location on the East End, where practice details, unit cost estimates, and installation and maintenance tips can be shared.

Unpaved Roads Action 3: Secure funding to begin survey work for high priority projects on Seven Flags Rd. and Hope and Carton neighborhood in order to fully develop restoration concepts.

Unpaved Roads Action 4: Complete master drainage plan for Hope and Carton neighborhood to indentify drainage improvements and potential stormwater retrofits, as well as a routine maintenance plan for the homeowners association and DPW.

Unpaved Roads Action 5: Coordinate with UVI to collect additional data and conduct additional analysis in GIS to assign slope, surface condition, and other input variables required to develop road erosion models for the East End. This data would compliment concurrent studies of hillside and trailhead erosion being conducted in Teague Bay and Turner Hole and could be used to better model TSS load estimates.

Unpaved Roads Action 6: Partner with TNC and property owner to stabilize the trail at the East End Marine Park as a demonstration project. Conduct a survey of beach access trails to determine the severity of erosion and if vehicular access is an issue, potential for improved parking and vehicular restriction. Work with local community groups, schools, and Homeowners/Condo Associations to “adopt-a-trail” and begin the process of designing trail restoration plans.

3.4 Culvert Repair and Replacement

Evidence of erosion, sediment transport, and wetland habitat loss from new culvert installations and unstable outfall discharges was observed in a number of the East End watersheds (e.g., Southgate, Turner Hole). Many existing culverts were completely blocked, crushed, undersized, or in need of maintenance/repair (Figure 8). Clogged culverts can cause flooding and/or the re-direction of stormwater flows to areas that are more susceptible to erosion. Data on the location, size, type, and condition of 97 visible culverts was collected and entered into GIS.

Table 9 lists the culverts in need of routine maintenance or more significant repair. Priorities are based on field team’s best professional judgment given significance of blockage, size of pipe, and relation to other potential restoration projects.

New or replacement culverts should be sized for the appropriate storm return frequency, watershed build out, gut grade control issues, downstream water quality, and potential fish/invertebrate migration. Rainfall statistics should be updated and applied. Incorporation of water quality structures and stabilization techniques into culvert design and construction may help reduce sediment loading and long-term maintenance needs. Recommendations for culvert installation, sizing, and maintenance will be important, particularly for areas in the East End where DPW is planning improvements (i.e., Rt. 624 in Great Pond and the East gut in Southgate). Figure 9 illustrates two examples of recently installed culverts and road drainage outfalls that could benefit from stilling basins and erosion and sediment control practices.

Figure 8. Blocked Culvert (Seven Flags) and Undermining of Culvert Headwall (Southgate East Gut)



We recommend some of the following actions to be completed in implementation years 1 through 5:

Culvert Action 1: Meet with DPW and HOA representatives to discuss culvert potential collaboration on routine maintenance of neighborhood drainage infrastructure. Review the list of priority culvert maintenance projects identified here, confirm responsible parties, and discuss the practical methods and schedules for implementation.

Culvert Action 2: DPW and DPNR to update Territorial infrastructure mapping/GIS data with culvert shapefiles developed under this project.

Culvert Action 3: Secure funding to develop design plans for priority culvert projects that are in line with DPW priorities, sizing standards, and maintenance capacity, such as the replacement of Southgate’s East Gut and the culvert adjacent to Milgies’s Grocery in Great Pond.

Culvert Action 4: Where feasible, incorporate stilling basins into culvert/outfall designs to provide for energy dissipation and sediment deposition (Figure 10), though this will be limited unless accumulated sediment is regularly cleaned out. New public outfalls and culvert installations should include the installation of temporary erosion and sediment control practices and serve as models for private developments. Develop guidance for culvert sizing for all new installations.

Figure 9. Example of Culvert/Drainage Outfalls in Need of Stabilization



Figure 10. Stilling Basin/Plunge Pool Detail

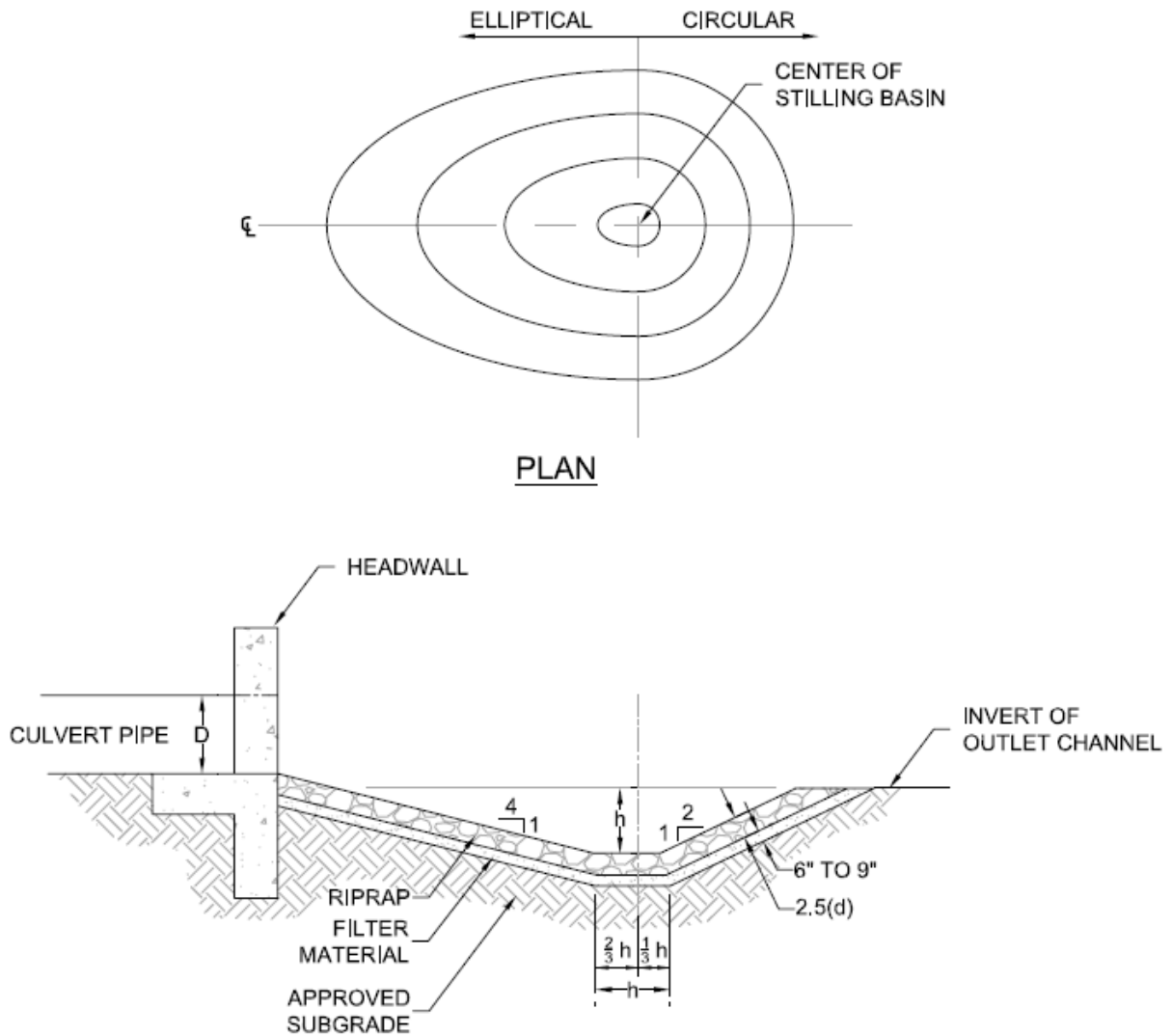

SECTION ALONG CENTERLINE

$$h = \left[0.148 \frac{Q}{D^{1/2} d^{1/2}} - 1.82dD^{2/3} \right]^{2/3}$$

Q = DESIGN DISCHARGE
 D = CULVERT DIAMETER
 d = RIPRAP d50 SIZE

OUTLET STILLING BASIN / PLUNGE POOL DETAIL

NOT TO SCALE

Table 9. Priority Culvert Maintenance and Repair Projects

Priority	Map ID	Field Form ID	Location	Diameter (inches)	Type	Description of Maintenance Needs
High	SB-4	SB-RC-16	Rte 82-Coakley Bay	18	RCP	scour hole at downstream end, needs stabilization and/or larger culvert
	SB-6	SB-RC-12	off Rte 82	48	CMP	manhole covers missing all along length. Outlet submerged.
	SB-14	SB-RC-9	Rte 82	24	RCP/CMP	mostly blocked by sediment. CMP is damaged on upstream end. Needs to be replaced with larger culverts.
	SB-15	SB-RC-9	Cotton Valley Trail	?	CMP	could not locate downstream end - presumed to be completely clogged
	SB-19	SB-RC-13	near Fire Station	24	CMP/DIP	could not locate upstream end due to vegetation at edge of pond. Downstream end is clogged with vegetation.
	SB-20	SB-RC-3	Pony Club Trail	30	CMP	Sediment from dirt roads pushed into upstream area of culvert. Very large scour hole at downstream end (15' deep, 20' wide) - culvert is undersized. Culvert bending from weight of road. Dumping in the area.
	SB-24	SB-RC-6	Rte 82	30	CMP	corroded CMP pipe retrofitted with RCP end sections. Culvert not in line with flow direction, some upstream erosion and sediment deposition observed. Downstream area has undercut and now ponds water.
	SB-26	SB-RC-19	Rte 82	24/8/8	CMP/PVC/ PVC	septic smell coming from downstream end. 2 PVC pipes from unknown source
	GP-7	GP-RC-2	Route 624 at Milgie's Grocery			replace culvert and realign gut
	SG-9	SG-RC-21	East End Rd	50X36/18	CMP/RCP	East Gut, next priority for DPW replacement in the EE. 18" RCP and two CMP arches; significant blockage; sinkholes behind headwall; deteriorating headwall; 20x40 ft scour hole downstream; drains Adams property
TB-20	TB-RC-2	East End Rd/Rte 82	24	CMP	completely crushed at outlet; inlet and headwall completely buried; needs replacement	
Medium	SB-7	SB-RC-11	Rte 82	30/30	CMP	becomes blocked with sediment/debris from Solitude Rd, needs regular maintenance
	SB-9	SB-RC-11	Solitude/Ziggy's/Top Side	30	CMP	frequently becomes blocked with sediment/debris from Solitude Rd, needs regular maintenance
	SB-17	SB-RC-18	Seven Flags	12	CMP	appears to be completely blocked
	SB-18	SB-RC-14	Rte 82 near Fire Station	30	RCP	downstream end is mostly submerged, scour hole present, gabion baskets need some repair
	SB-22	SB-RC-4	unknown	24	DIP	corrosion at downstream end, and scouring down to wet pond

Priority	Map ID	Field Form ID	Location	Diameter (inches)	Type	Description of Maintenance Needs
	SB-25	SB-RC-7	Rte 82/Blue Water Terrace	15	RCP	downstream end flowing through private property. Pipe deterioration evident, and pipe appears to be completely blocked. Concrete swale constructed on top of pipe for direct road runoff - this is also deteriorating. Discharges directly into ocean.
	GP-2	GP-RC-1	Route 624	15/24/15	RCP/RCP/DIP	downstream scouring; inlets partially blocked w/minor sedimentation, large concrete headwall
	GP-4	GP-RC-5	Marienhofj/Maria Lane?	?		west culvert completely buried; size/type unknown; only portion of small headwall/inlet structure above ground
	GP-5	GP-RC-4	Maria Lane East	24	CMP	inlet partially blocked; significant erosion/scour on bank at outlet; outlet suspended; concrete dumped above outlet on road shoulder (most likely disposal activity and not effort to control/direct stormwater)
	SG-1	SG-RC-6	Crescent Beach Rd	24	RCP	erosion up and downstream of culvert, riprap failing
	SG-6	SG-RC-2	East End Rd	36	CMP	in front of Seven Seas, good swale pretreatment, pipe is failing and blocked (at outlet)
	SG-7	SG-RC-1	East End Rd	18	RCP	ditch in front of Cheeseburgers, < 1-2" capacity remaining, needs simple backhoe/drainage maintenance
	SG-18	SG-RC-7	Seven Hills	15	DIP	with drain inlet, needs basic maintenance
	SG-19	SG-RC-7	Seven Hills	12	DIP	needs basic maintenance
	SG-20	SG-RC-7	Seven Hills	27	DIP	erosion at inlet and at outlet; gullies forming
	SG-21	SG-RC-7	Seven Hills	24	RCP/CMP	needs basic maintenance
	SG-22	SG-RC-7	Seven Hills	18	DIP	
	SG-23	SG-RC-7	Seven Hills	24	DIP	
	SG-24	SG-RC-7	Seven Hills	24	DIP	
	SG-25	SG-RC-7	Seven Hills	24	DIP	
	SG-26	SG-RC-7	Seven Hills	18	DIP	needs basic maintenance
	SG-27	SG-RC-7	Seven Hills	30	DIP	debris maintenance
	TB-19	TB-RC-1	East End Rd/Rte 82 Duggan's Entrance	22	DIP	3ft concrete headwall (damaged); damaged/partially blocked; culvert needs replacement
	TH-1		South Shore Rd	24	RCP	2/3 buried
Low	SB-1	SB-RC-15	Rte 82	18	RCP	scouring on downstream end, needs riprap
	SB-2	SB-RC-15	Rte 82	18	RCP	some chipping of pipe, blockage
	SB-3	SB-RC-15	Rte 82	15	RCP	farmland upstream, downstream end undetermined (private property). Upstream blockage of sediment and vegetation.
	SB-5	SB-RC-17	Rte 82	24	RCP	scour hole at downstream end, needs stabilization and/or larger culvert
	SB-10	SB-RC-10	Solitude	30	CMP	some erosion issues here

Priority	Map ID	Field Form ID	Location	Diameter (inches)	Type	Description of Maintenance Needs
	SB-11	SB-RC-10	Solitude	30	CMP	some erosion issues here
	SB-21	SB-RC-2	unknown	24/24	CMP/CMP	Dry pond at upstream end. Slight scouring at downstream end. Could use some riprap to help stabilize
	SB-23	SB-RC-5	unknown	24/24	DIP/DIP	Pipes bent and corroded. Grate/fencing on upstream end is in disrepair, scouring on downstream end. Appears undersized - flows over road in this location.
	GP-1	GP-RC-34	S Shore Rd	12	RCP	sediment on upstream side recently scooped out with backhoe, potential to retrofit with a concrete drainbox with a sump. Need to clean out pipe and stabilize outfall
	GP-3	GP-RC-3	Route 624	36	CMP	6.5-foot concrete headwall; scour hole downstream - stabilize w/riprap; moderate sedimentation upstream; culvert in good condition
	SG-3	SG-RC-35	Spicewood Rd	12	RCP	broken and clogged culvert
	SG-4	SG-RC-36	Southgate Crossing	--	CMP	roadside ditch; clogged on downstream end; homeowner may be encouraging clogging, parcel good demo for residential raingarden and pavers
	SG-5	SG-RC-20	East End Rd at Church	15	RCP	near Baptist Church; significant blockage; cracking
	SG-10	SG-RC-5	South Shore Rd	24	RCP/CMP	downstream pipe mostly plugged up with sediment and debris
	SG-11	SG-RC-4	South Shore Rd			driveway culvert (couldn't see completely), partial blockage with vegetation
	SG-12	SG-RC-30	South Shore Rd	24	RCP/CMP	partial blockage, low priority. Needs basic vegetative maintenance/debris removal. CMP is deteriorating. 50% submerged with scour pools. Has a 6.5x5 ft concrete channel at headwall; downstream and upstream look good.
	TB-4		East End Rd	42	CMP	corroded with rust; stable outfall
	TB-9		East End Rd	24	CMP	drop box; rusted invert
	TB-16		East End Rd/Rte 82	18	CMP	damaged culverts; need maintenance/replacement
	TB-18	TB-RC-1	Duggan's parking lot	12	PVC	good condition; minor sedimentation in pipes
	TB-21		Reef Golf Drive	20	DIP	corroded
	TB-25		Pelicano Rd		DIP	corroded, short length of pipe

This page intentionally left blank.



4.0 Non-structural Management Actions

To address management **recommendations #2, #3, #7, and #8**, a number of non-structural management opportunities were identified to prevent pollution, enhance regulatory controls and program implementation, and develop a targeted education and outreach strategy.

4.1 Pollution Prevention

A few locations where trash and other pollutants have a high potential to be conveyed into guts, wetlands, or coastal areas were identified during field investigations. Illicit dumping, improper waste management, exposed storage of materials, pet waste, and landscape maintenance all can contribute unnecessary oils, organics, bacteria, and toxics to stormwater. Solid waste management is a challenge in the USVI; however, any non-structural or structural projects that could reduce pollution should be considered high priorities (e.g., signage, blocking vehicular access to areas of frequent dumping, household hazardous waste pickup days, covering and/or relocating dumpsters, and providing secondary containment for outdoor storage).

Most pollution prevention opportunities identified during field investigations related to preventing illegal dumping and improving waste management and outdoor material storage at trash collection centers, restaurants, and other local businesses (Figure 11). Restrictions on vehicular access may help limit illegal dumping (or shift it to other areas, preferably to designated trash collection centers). Posting of signage prohibiting dumping should link to resource protection goals of the STXEEMP and provide the locations of places where trash can be taken legally. At a minimum, dumpsters should be covered to prevent rain from coming into contact with waste materials and should be located away from guts and wetlands. Outdoor material storage should also be protected from the weather, and include secondary containment in case of spills. Grease traps at restaurants should be located away from drainage paths.

In addition, on-site material storage at small construction projects may also be challenging given space limitations. While not necessarily required to meet the same Erosion and Sediment Control standards of large developments, contractors have a responsibility to prevent materials from leaving the site. Figure 12 shows effective covered stockpile and daily sweeping to retain stockpile materials on site, and less effective material management off-site.

Specific pollution prevention measures for improving the quality of wastewater discharges were not evaluated under this watershed planning efforts, although new septic systems and small wastewater treatment systems associated with new development should use the best technology available.

Figure 11. Examples of Outdoor Material Storage and Dumpster Management (note the use of plastic swimming pool as cost-effective secondary containment).



Figure 12. Effective and non-effective material management on small construction sites



Table 10 lists seven specific locations identified during field investigations for pollution prevention. These sites are all considered high priorities since pollution prevention activities are important and very cost-effective control strategies. See [Appendix C](#) for additional detail for some of these sites.

We recommend all of the following short-term actions be completed in implementation years 1 through 5:

Pollution Prevention Action 1: Coordinate with community groups to conduct quarterly trash pickup days at key locations. This can be linked with existing “Beach Sweep” initiatives and events like Reef Jam.

Pollution Prevention Action 2: Develop design plans for the relocation of the Cotton Valley Dumpster site that include construction of an enclosed structure with concrete floor, side walls and roof (see Appendix C Design Concept for Fire Station).

Pollution Prevention Action 3: Consider establishing a voluntary STXEEMP-Friendly Business program that provides local businesses with assistance developing a site specific pollution prevention plan to outline proper waste management and material storage procedures and practices. In exchange, participatory businesses can become eligible for small matching grants to implement pollution prevention activities (e.g. purchasing lids for dumpsters, covered storage sheds, secondary containment, etc) and have special advertising with the STXEEMP and island tourism programs.

Table 10. List of Pollution Prevention Locations

Site ID*	Location	Description
SB-R-1	Fire Station	Provide a covered dumpster enclosure with short concrete walls, chain link and designated area with secondary containment for “swap shop.” Consider adding a household oil/gas collection area to be maintained by the fire department.
GP-R-1	Great Pond Parking	Trash cleanup, postage of signage, and limiting vehicular access at parking area adjacent to pond.
SG-R-20	Chenay Bay	Clean-up trash and debris from parking lot and landscape maintenance that is in wetland and buffer area. Cover outdoor material storage area. Work with Chenay Bay to develop alternative maintenance procedures for debris removal.
SG-R-3	Green Cay Marina	Poor dumpster management at the Marina results in trash in wetland area. Relocate and/or construct a covered enclosure. Join the US Clean Marina Program to take credit for existing vessel pump out, spill response, and other good practices.
SG-H-1	Chenay Bay Beach Cleanup	Conduct quarterly trash cleanup with SEA volunteers and Chenay Bay.
--	Solitude Beach	Organize quarterly trash cleanup at Solitude Beach with local residents (location undetermined, this site was added from a stakeholder meeting).
SB-H-1	Blue Water Terrace	Reduce wash water disposal and dumpster juice draining to gut through alternative procedures and dumpster management.

4.2 Regulations, Programs, and Policies

Given the concurrent updates to the zoning regulations, wellhead protection program, and water quality standards, a thorough evaluation of environmental regulations and policies related to watershed management was not completed as part of this effort. That being said, there are a number of specific actions that would go a long way in supporting the watershed

management strategy in the East End, specifically, and improve water resource protection across the USVI, in general. These actions were developed based on discussions with agency and public stakeholders.

We recommend as many of the following short-term actions as possible be completed in implementation years 1 through 5:

Territorial Program Action 1: Do not wait for advanced plan review during the permit approval process to establish agency expectations of stormwater and wastewater management practices. These projects, if caught early enough in the planning stage could incorporate low impact development (LID) techniques, enhance water management and hydrologic balance, and serve as demonstration projects. Revise submittal requirements and permitting checklists to include basic information on the proposed approach to managing LBSP on site. This is particularly important for the proposed Wyndham and Robin Bay development.

Territorial Program Action 2: Update development regulations and stormwater standards to protect water resources (e.g., require installation of drainage infrastructure in addition to paving of roads for subdivision projects). Even for minor permits and small site construction, proper ESC should be enforced. Requiring more advanced treatment systems for new developments may be recommended, as well as capacity upgrades for systems that manage infrequent, but large storm events. Consideration should be given for single lot construction standards regarding advanced systems, setbacks from guts, and minimized limits of clearing.

Territorial Program Action 3: Establish stormwater design criteria for water quality, runoff reduction, gut protection, and recharge and adopt a legally binding and locally-appropriate stormwater design manual for the USVI. It is important that stricter design standards are applied to new development projects that have the potential to increase existing pollutant loading to sensitive waters of the STXEEMP.

Territorial Program Action 4: Improve existing enforcement and complaint response procedures for erosion and sediment control violations resulting from construction activities in the East End. Provide office space in Christiansted for one to two enforcement officers located in Frederiksted to allow for an increased presence on the East End and to shorten response times for on-site inspections. Enforcement, reportedly, used to maintain an office near DPW in Anna's Hope. Establish and promote a dedicated complaint hotline for citizens to report sedimentation and other pollution issues to appropriate DPNR officials and for agency staff to follow-up with citizen reporters.

Territorial Program Action 5: Update land use, zoning, paved/unpaved roads, and drainage infrastructure maps (i.e., culverts, pipes, stormwater management facilities) across the USVI. Revised data sets will be critical for the Water Quality Program in developing TMDLs for the Southgate watershed over the next year, as well as for DPW infrastructure maintenance and planning, as well as the TPDES program BMP maintenance and retrofit tracking programs.

Territorial Program Action 6: Revise restoration implementation priorities for the Southgate and other watersheds as TMDLs are developed and approved, or as changing water quality standards result in de-listing of receiving waters (e.g., Isaac Bay).

Territorial Program Action 7: UVI should coordinate a professionally facilitated interagency work session to develop a proposed unified gut and wetland protection strategy for departmental and legislative consideration. Currently, regulatory mechanisms are not in place to protect these natural systems from the impacts of development. As the East End continues to develop, additional degradation of guts and wetlands is unavoidable (e.g., buffer encroachment, increased stormwater discharge, sediment deposition, and continued erosion). Policies should clearly establish requirements and restrictions on the permitting of gut alterations, piping of guts, design of new discharge outfalls, wetland buffer protection and enforcement, invasive species/vegetative management, and land subdivision procedures. The take home message for a gut management policy should be that channelization, filling, and piping of guts should be avoided wherever possible.

Territorial Program Action 8: Investigate the Territory's official participation in NOAA's Federal Clean Marina Program. Several states including Florida, have established these programs to better advance pollution prevention activities specific to marinas ranging from vessel pumpouts, fueling practices, and managing discharges from boat maintenance operations. Subsequently, there are many existing checklists, educational programs and other program materials that can be adapted for the USVI at low cost.

Territorial Program Action 9: Consider administering a local contractor and equipment operator erosion and sediment control certification or required licensing program.

Territorial Program Action 10: The USVI Territorial Emergency Management Agency is currently updating hazard mitigation plans and should weigh-in on major development and drainage infrastructure priorities. A significant portion of the Southgate and Great Pond watersheds, and some of the proposed new developments, are within the 100-yr floodplain. Therefore, future development proposed around existing guts and wetlands will likely need to meet existing (or more stringent) setback requirements. The setback distance (or buffer zone) should be determined through consideration of slope, aspect, vegetative cover, and other relevant factors. Despite the 1993 Great Pond APC Management Report discouraging development in the pond floodplain, a resort/casino development is proposed, and land reclamation activities are reportedly underway. Development here will not only have a significant risk of flooding, but will potentially have an adverse effect on hydrology in upstream residential areas and on the pond itself.

Territorial Program Action 11: Establish septic system inspection and maintenance requirements for areas where system failure is high. Soils, high groundwater elevations, and percentage of undeveloped lots could be factors used to identify which neighborhoods may be

higher priorities for promoting free septic inspections, subsidizing maintenance, or requiring new septic designs.

Territorial Program Action 12: Improve transparency of water quality information by posting on DPNR’s website approved reports or annual summaries of small package system effluent monitoring reports, beach closure summaries, and enforcement actions.

Territorial Program Action 13: Complete a mapping analysis and field investigation to determine potential land use threats within a 1,000-foot radius of permitted wells.

4.3 Education and Outreach

One of the most significant watershed management activities is simply raising awareness of watershed issues and providing opportunities for local stakeholders to reduce LBSP impacts on the STXEEMP. To this end, a targeted education and outreach plan is proposed below to increase awareness of key watershed behaviors that may negatively affect the surface waters and resources of the St. Croix East End Marine Park (EEMP). The purpose of an education plan is to further implementation of priority projects, and foster broad community awareness of watershed issues within the East End. An education plan is required by EPA in order to be eligible for watershed plan implementation grant funding.

The following actions have been developed to effectively engage watershed residents, businesses, farmers/agriculture, regulators, and tourists in voluntary watershed stewardship activities. Efforts have been made to identify key messages, delivery mechanisms, and integration opportunities with public sector education and outreach programs already existing in the USVI (e.g., St. Croix EEMP, USVI Drinking Water Program, and the DPNR Education Office). Implementation of most of these education and outreach activities is proposed for implementation years 1-5.

4.3.1 Targeting the Residential Community

Five of the six East End watersheds have residential and/or condominium developments, for a total of 22 neighborhoods and condominium complexes across the East End. In Southgate, Great Pond Bay, Solitude, Teague Bay, and Turner Hole, residential/condominium developments comprise the primary land use. Table 11 lists potential stewardship activities identified during field investigations of East End neighborhoods.

Residential Education Action 1: St. Croix EEMP Education/Outreach Coordinator to host an invitation-only meeting with presidents of each East End Home Owner Association (HOAs) and Condominium Association to review watershed plan recommendations and identify key education needs and outreach opportunities. These educational meetings could lead to development of guidance for the proper procedures for road, driveway, and culvert maintenance, or generate potential support for retrofit demonstration projects. Publish a

meeting summary in the *Avis* to promote awareness among other residents regarding common practices they can adopt within their neighborhoods that are being implemented in other areas in the East End.

Residential Education Action 2: STXEEMP or SEA could host a watershed education website where links to basic homeowner education guidance material can be posted (e.g., homeowner guides to septic system inspection and maintenance on the Coral Bay Community Council and RC&D websites). Many existing materials including publications, presentations, and basic homeowner environmental education were also previously developed by UVI-CES and could be relocated to a watershed education website.

Residential Education Action 3: Publish bimonthly newsletter articles featuring landscape practices and vegetation management strategies congruent with the priorities and goals of the watershed plan. STXEEMP in conjunction with DPNR should run radio ads on the importance of septic system inspections, proper pet waste disposal, and proper disposal of hazardous household materials to the protection of coastal waters. Create an informational pamphlet highlighting the importance of proper disposal of such materials in relation to LBSP for distribution at key events, such as Reef Jam. Post advertisement/digital copy of pamphlet on the USVI Waste Management Authority Website.

Residential Education Action 4: Investigate the potential benefits of installing pet waste disposal stations at Condo Associations or Cramer Park.

Residential Education Action 5: Promote neighborhood pride and participation in community culvert maintenance, rain garden demonstrations, and trash pickup days by hosting an annual watershed restoration contest and neighborhood stewardship award.

Residential Education Action 6: VI Waste Management Authority to host a demonstration on the Do-It-Yourself Used Oil Collection Program or host a battery and/or tire recycling day for East End residents. Advertise date in the *St. Croix Avis* and *St. Croix This Week*. November 15th is America Recycles Day during VI Recycles Month.

Residential Education Action 7: Develop a guide for homeowners that would illustrate watershed best management practices on small lots (e.g., construction, septic, pet waste, vegetation management, driveway management, and rain gardens).

Table 11. Targeted Residential Education Messaging Based on Field Observations

Neighborhood	Potential Stewardship Activities						
	Road, culvert, or driveway maintenance	Gut mgmt.	Veg. mgmt.	Stormwater retrofit (on-lot or larger)	Pollution prevention	New residential construction mgmt.	Septic survey
All for the Better/ Tipperary (SG)	X	X	X	X	X		X
Catherina’s Hope (TB)						X	
Cotton Valley (SB)	X	X			X		X
Grapetree Bay (TH)						X	
Hilltop Circle (TB)	No action identified						
Hope & Carton Hill (SB)	X	X		X			
Mt. Washington (SG/GP)					X	X	
Marienhof (GP)						X	
Parara (SG)					X		
Pleasant Valley (SB)	X	X	X	X			
Punnett Bay (Shoy’s) (SG)		X	X	X			
Green Cay/Prune Bay (SB)	X		X	X			
Reef Condos (TB)	No action identified						
Sally’s Fancy (GP)		X	X		X		
Seven Flags (SB)	X			X			
Seven Hills (SG)	X						
Sierra Verde (SB)	X			X			
Solitude North (SB)						X	
Southgate Farm/Anna’s Hope (SG)			X	X			
Union (GP)							X
Villa Madeline (TH)				X			
Yellow Cliff North (SB)	X						

SG= Southgate; SB = Solitude Bay; TB= Teague Bay; TH=Turner Hole; MC=Madam Carty; GP=Great Pond

4.3.2 Targeting the Business Community

Marinas, hotels, restaurants, golf courses, and a gas station comprise the other main land-use types within the East End. Independent engineering firms, construction contractors, and equipment operators, landscapers, and septic system specialists working in the East End also can play an important role in watershed management. A number of watershed recommendations have been previously discussed, including improved stormwater and wastewater management and pollution prevention. Specific education actions include:

Business Education Action 1: STXEEMP staff to host an invitation-only meeting with area businesses (e.g., Reef Golf, Divi Casino & Resort, St. Croix Yacht Club, Ziggy's) to review the watershed recommendations, existing conditions, and potential implementation options.

Business Education Action 2: Establish the STXEEMP-Friendly Business Program to assist local businesses in assessing and implanting cost-effective pollution prevention practices on site. Businesses could be provided a certification award with decal/sticker to display, may become eligible for matching grant funds for implementation, and could potentially benefit from additional advertising.

Business Education Action 3: Partner with VI Waste Management Authority on a grant to purchase dumpster lids for distribution to East End business.

Business Education Action 4: Conduct a public stormwater retrofit demonstration at a local business. The retrofit project should be advertised in the St. Croix *Avis* in advance of project implementation. A follow-up article to be run in the *Avis*, as well as the STXEEMP newsletter and/or the DPNR and NRCS website.

Business Education Action 5: Partner with industry representatives, SEA/CBCC, UVI, and DPNR to target two professional groups each year with free technical training workshops on preferred approaches and new technologies for the following topics: septic design and maintenance, stormwater management, construction site erosion and sediment control, road grading and drainage design, and buffer management.

4.3.3 Targeting the Agricultural Community

Farming and agriculture is another common and locally-important land use within the East End. Several watershed goals and priorities have been identified for this target audience and include: Farm Pond Maintenance/Improvements; Gut Management Practices/Buffer Protection; and Waste Management. Specific education actions include:

Agricultural Education Action 1: NRCS to establish STXEEMP farmer cooperative that meets quarterly on rotating sites to evaluate and propose restoration alternatives for gut maintenance, buffer protection, pond maintenance, and wastewater management on agricultural lands. This provides an opportunity to share lessons learned, establish partnerships for grant funding opportunities, and develop an inventory of pond maintenance and others restoration projects.

4.3.4 Targeting the Regulatory Community

To implement many of the territorial program and regulatory recommendations in Section 4.2, it will be critical to educate commissioners, legislators, and other politicians on the potential consequences of watershed activities on environmental resources and basic drainage patterns.

In addition, to promote common dialogue and enforcement efficiencies, continue providing inter-agency technical training for staff on watershed and stormwater management priorities. Specific education actions include:

Regulator Education Action 1: Hire an un-biased facilitator to conduct ½ - 1 full day training for commissioners and/or politicians to demonstrate the connection between land use management decisions, capital expenditures, water quality standards, and enforcement activities on the quality of water resources. Optional afternoon sessions should include field trip to stormwater management facility, gut, construction site, or pollution source to demonstrate specific gaps in existing programs and the direct impacts on water resources.

Regulator Education Action 2: Develop a hydrology handbook for non-engineers to identify key elements to look for when evaluating development applications from a stormwater perspective. This could be especially helpful to plan reviewers, commissioners, politicians, and other non-technical parties with an interest in rapidly identifying opportunities for improving stormwater management at the site-scale. As an example, the *Hydrology Handbook for Conservation Commissioners* provides a resource for non-technical, elected officials in Massachusetts to better understand the hydrologic impacts of development and redevelopment projects on wetlands (<http://www.mass.gov/dep/water/laws/hydrol.pdf>).

Regulator Education Action 3: Conduct bi-annual construction site inspection training for enforcement staff and contractors. This could focus on the installation and maintenance of temporary erosion and sediment control practices, as well as permanent stormwater facilities.

4.3.5 Targeting the Tourists

As the East End becomes more of a tourist attraction, a number of opportunities will arise to broaden the watershed message to a user group that can have a significant, yet unknowing, impact on the STXEEMP.

Visitor Education Action 1: STXEEMP and DPW to install watershed signage announcing entrance into the STXEEMP watersheds on East End Rd. to promote awareness of the importance of the area and the connection between land and marine park to visitors. Watershed information should also be included in signage at parks and trailhead restoration projects to illustrate the watershed stewardship efforts underway in the USVI.

Visitor Education Action 2: STXEEMP to create an informational pamphlet providing an overview of the East End watershed, and STXEEMP-friendly businesses to have available at various tourist kiosks.

Visitor Education Action 3: STXEEMP, in conjunction with business outreach, to provide stickers/placards for posting at resorts/hotels, condos, and home rentals to remind visitors of wastewater disposal constraints to help reduce septic failure and treatment plant problems.



5.0 Implementation Strategy

This section presents a preliminary implementation schedule for allocating efforts over the next five years, summarizes key strategies to apply in each individual watershed, and makes suggestions on methods to evaluate progress and success of implementation activities over time. The complete implementation of watershed plan recommendations can take decades. Over time, significant changes will likely occur in conditions on the ground, local priorities, funding opportunities, and the participation of stakeholder and key implementation partners. The failure to track changes and update watershed plans on approximately a five year cycle can render plans obsolete.

5.1 Preliminary Implementation Schedule

In order to advance implementation, at least in the short-term, it is advantageous to establish a preliminary schedule, that includes an estimated budget, and assigned roles for meeting each of the management recommendations outlined in [Section 2.0](#) through the actions listed in [Sections 3.0](#) and [4.0](#). The schedule presented in Table 12 is preliminary in nature, and is intended to provide a platform to launch internal planning discussions among implementation and funding partners. Not all actions and management recommendations identified in this report are included in this early implementation schedule; however each management recommendation is represented with some level of effort. For **\$2,000,000**, implementation of a number of key structural and non-structural projects can be accomplished within the first five years. It should be noted that implementation is already underway on a number of priority recommendations (e.g., SEA secured funding from USDA to develop master drainage plan for Hope and Carton neighborhood and develop engineering designs for Adams' gut).

Identifying the correct implementation partners is critical to advancing watershed activities. For many of the projects listed in this plan, consider the following when identifying responsible parties:

- **Stormwater retrofits**—property owner must be engaged and willing to either maintain project or turnover maintenance easement to territorial agency; technical and engineering support will likely need to come from DPNR or DPW or third-party engineer. Permitting agents will also need to be involved.
- **Road stabilization and culvert repair**—homeowners associations will be primarily responsible for drainage improvements on private road networks. DPW will be the key project partner for projects affecting public roads.
- **Gut stabilization**—property owners, NRCS, DFW, and permitting authorities will be likely implementation partners. Buffer enhancement, exclusionary fencing for livestock, and

potential easement establishment along guts during restoration projects should be considered, particularly where grant funding has been used to fund project.

- **Education and outreach**—implementation is likely to be the responsibility of STXEEMP, particularly for coordination with other agency education programs, schools, and community groups.
- **Territorial programs and regulations**—implementation leads will be agency-specific, but should be assigned and tracked by the watershed coordinator.

5.2 Individual Watershed Implementation Priorities

This watershed plan presents recommendations to minimize the impacts on the STXEEMP from all six watersheds, collectively. Modeling provides insight into the pollutant load allocation within each watershed, which may help prioritize restoration efforts at the watershed scale, where necessary (Figure 13). A review of individual watershed characteristics, conditions, and management opportunities was presented in the STXEEMP Watersheds Existing Conditions Report. Based on this information, a summary of overarching watershed management strategies for each individual watershed is provided in Table 13.

5.3 Evaluating Implementation Progress

Evaluating implementation progress and measuring performance of structural and non-structural practices to achieve the overarching watershed goals is critical to determining the success of a watershed planning effort and to secure additional funding. Before implementation gets too far underway, the watershed coordinator and implementation committee should establish a formal tracking and monitoring program that may include:

- **Annual progress report** and ½ day meeting—this forces the watershed team to track implementation actions completed that year, review budgets for the following year, and update plan priorities as necessary. Annual reporting also allows the watershed coordinator to brief agency staff, elected officials, funders, and the public on watershed management progress. This effort can help improve communication with implementation partners, keep watershed activities on the front burner as capital budgets and other agency priorities are being established, and keeps watershed stewardship in the public conscience.
- **Monitoring plan**—develop a scientifically-sound monitoring plan for establishing baseline conditions before restoration activities are in place, and measure individual project performance over time. This plan should integrate with existing water quality efforts of UVI and the DPNR.
- **Tracking database**—establish a repository of watershed data including GIS files to track installation, monitoring, and maintenance of restoration projects; cost information for individual projects; and watershed stakeholder contacts and listservers, etc.
- **Performance Metrics**—develop a list of performance metrics to be used to evaluate progress towards meeting each of the three watershed goals. Examples are provided in Table 14.

Table 12. Preliminary Implementation Schedule over Next Five Years*

Action**	Lead	Implementation Year and Planning Level Cost Estimate (thousands of \$)				
		1	2	3	4	5
MR 1: Hire or assign a full-time watershed coordinator and convene quarterly implementation committee meetings	DPNR	\$60	\$60	\$60	\$60	\$60
MR 2: Shared office space for additional DPNR enforcement staff to be housed in Christiansted; Operation and Administration of Hotline	DPNR (DEP)	\$40	\$40	\$40	\$40	\$40
MR 2: Develop Stormwater Design Manual and training	DPNR (DEP)	\$25	\$125	\$25		
MR 4: Conduct master planning for Hope and Carton Road Network; and install early action stabilization project at Goat Hill Road	SEA, TNC	\$80				
MR4: Implement two additional road stabilization projects	SEA, DPW		\$12	\$100	\$100	
MR4: Complete engineering designs for two gut restoration projects; implement in Years 2 and 4.	SEA, USDA	\$25	\$200		\$150	
MR5: Install 1-2 early implementation retrofits	DPNR (DEP)	\$30	\$60			
MR5: Complete designs and complete retrofit of two existing stormwater facilities; link with stormwater manual training	DPNR (DEP)			\$25	\$100	\$100
MR5/2: Host workshop/meetings related to retrofitting and gut/wetland strategies	STXEEMP, UVI		\$25		\$25	
MR6: Complete Pond Survey, complete design and install one pond restoration project	USDA			\$25	\$25	\$50
M7: Complete two Education/Outreach Actions per year	SEA, STXEEMP	\$10	\$10	\$10	\$10	\$10
M9: Initiate performance monitoring at restoration projects and establish sentinel baseline stations	UVI		\$10	\$15	\$10	\$15
MR4/2/8/9: Update existing GIS data and establish formal infrastructure tracking and maintenance database	CZM, DPW	\$5	\$5	\$5	\$5	\$5
Annual Total		\$275	\$547	\$305	\$525	\$280
Total		\$1,932				
* Does not encompass <u>all</u> the recommended actions listed in this Management Plan, only a subset.						
**For ease of reference to detailed description, MR equals Management Recommendation as listed in Section 2.						

Figure 13. Estimates on Pollutant Load Source Allocations for each STXEEMP Watershed

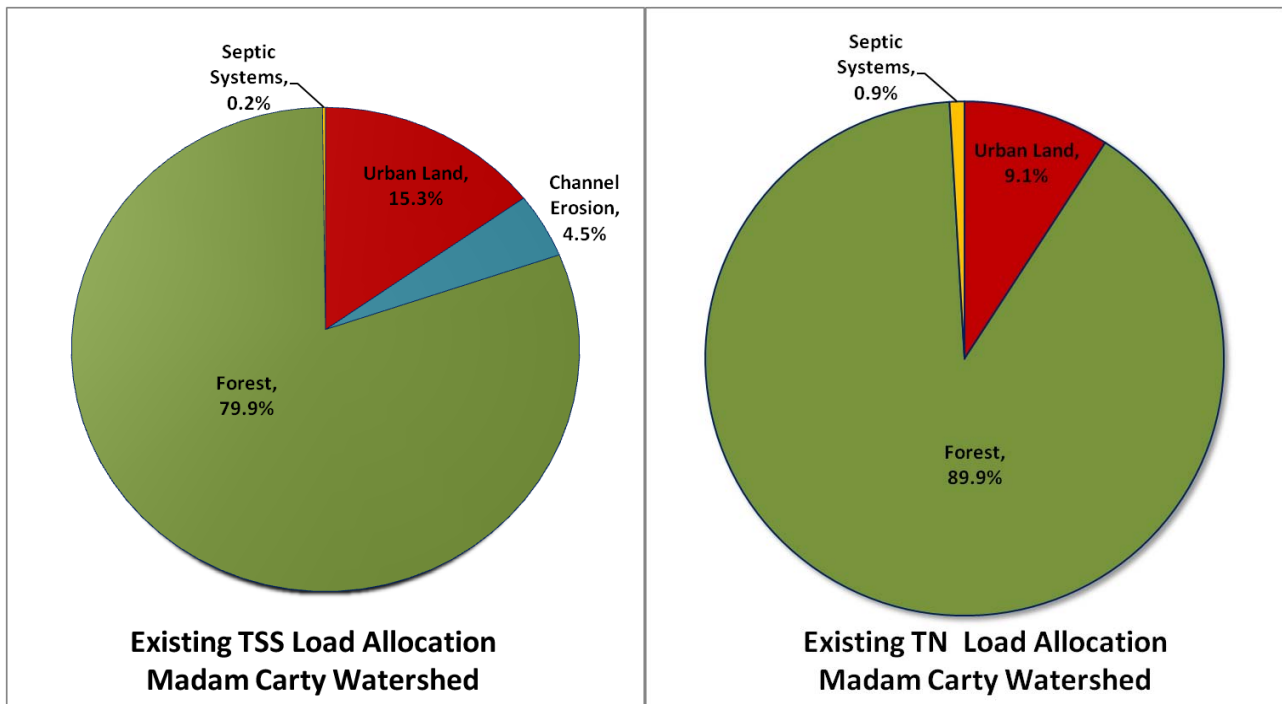
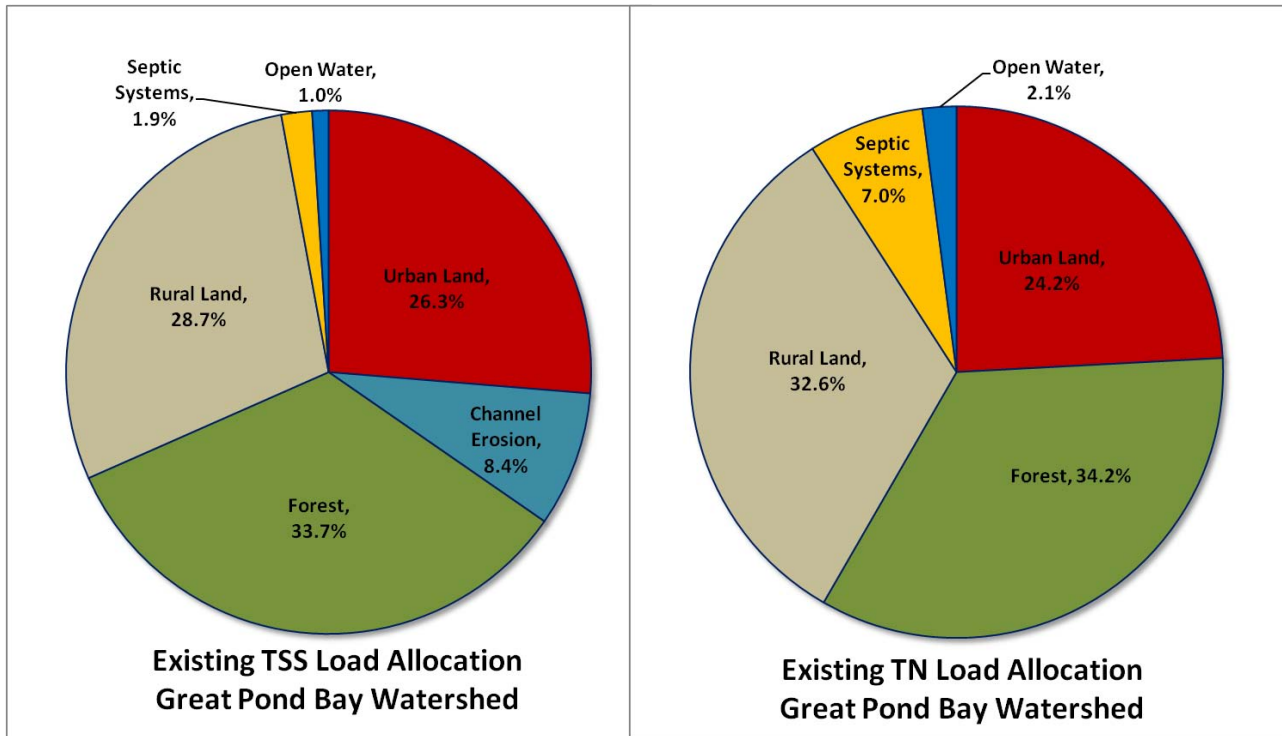

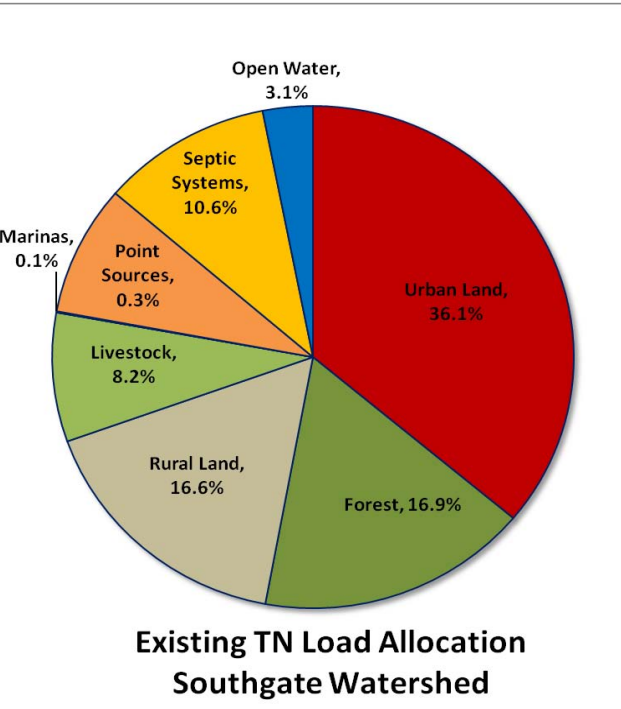
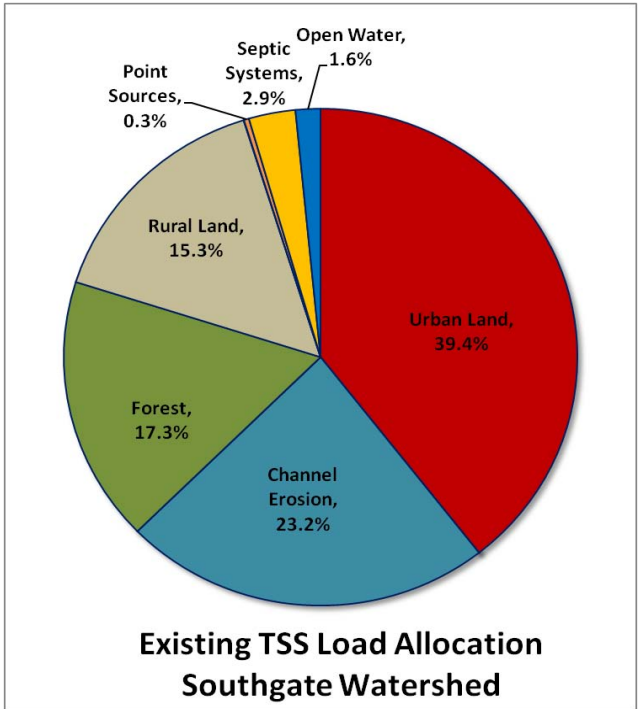
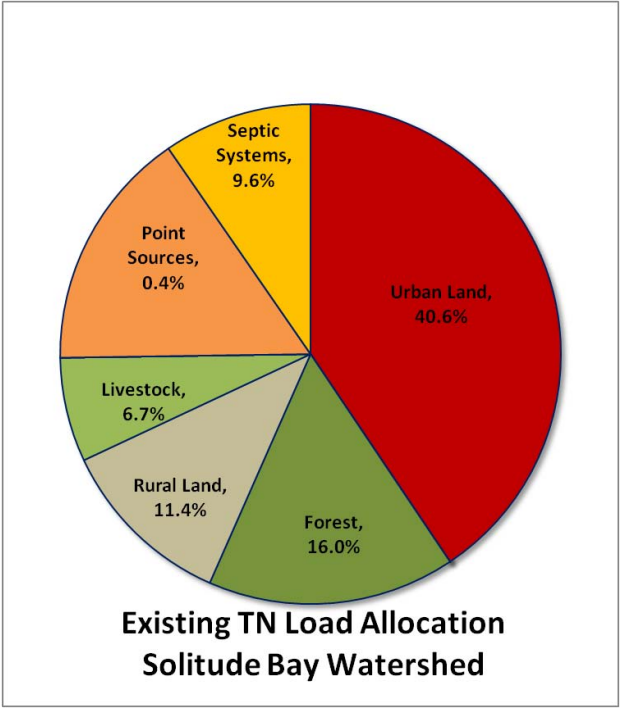
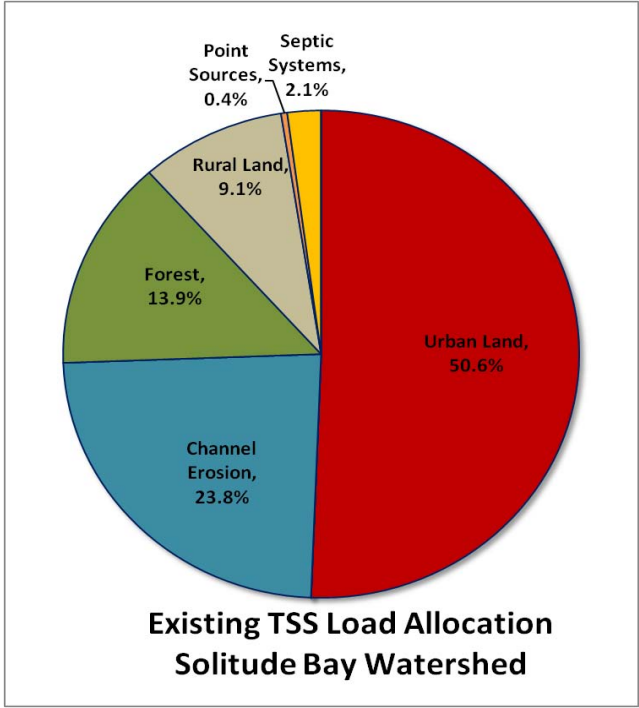

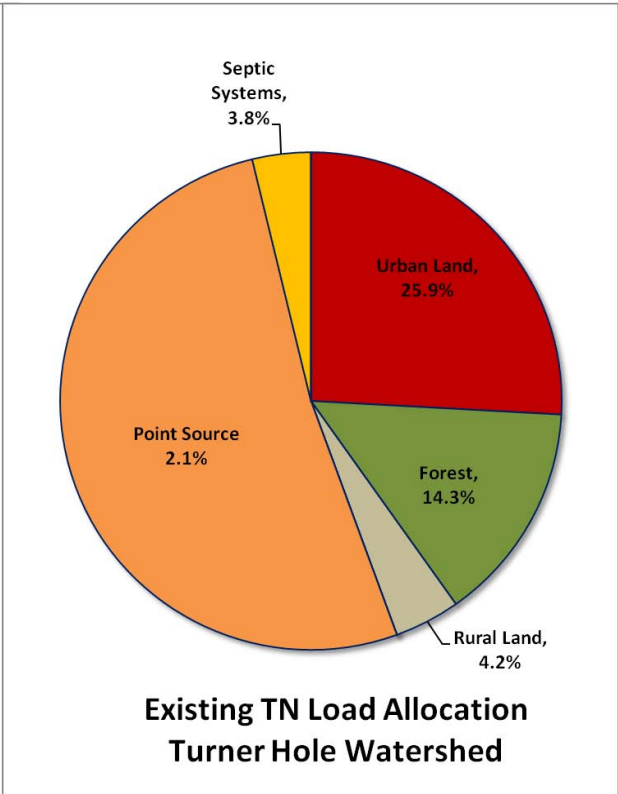
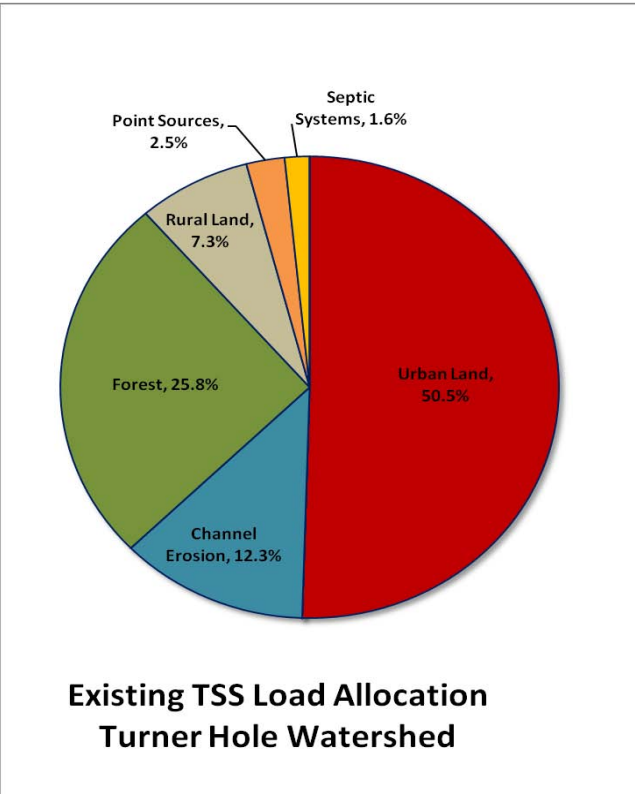
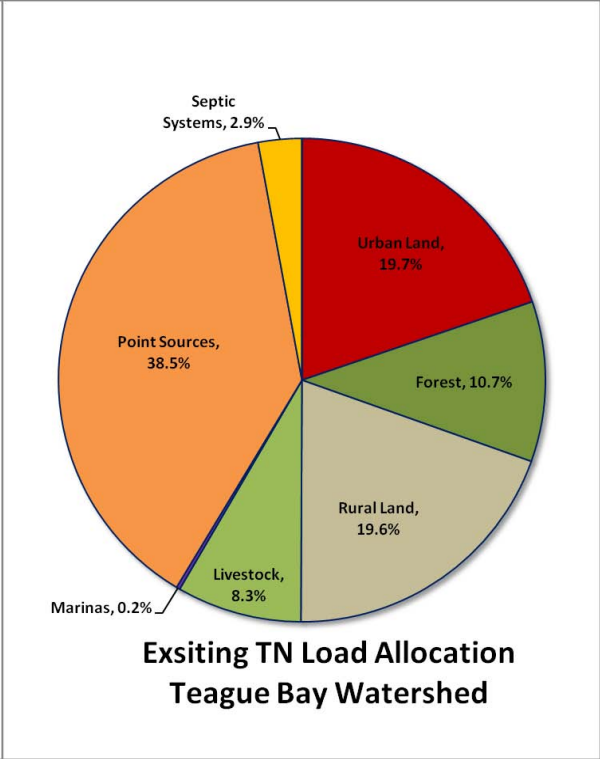
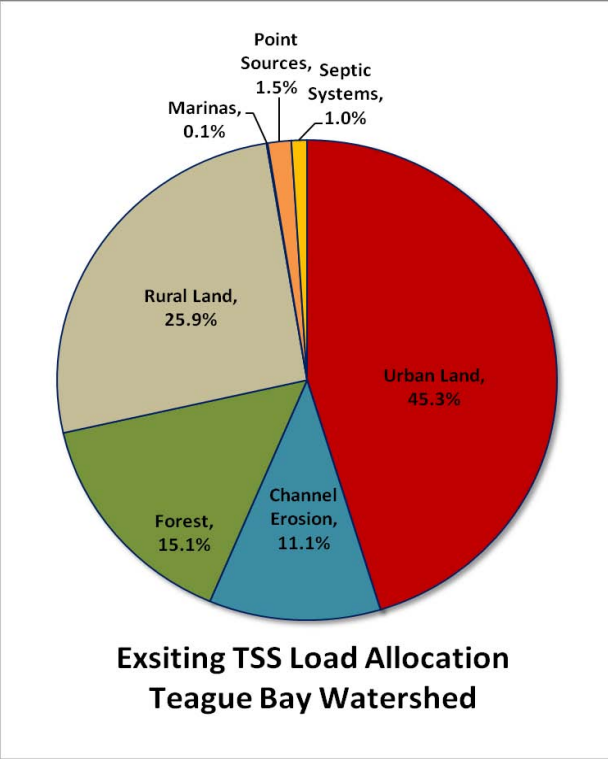

Table 13. Key Management Strategies for each Individual Watershed

Watershed	Management Priorities
Great Pond	<ol style="list-style-type: none"> 1. Prevent impacts from proposed development in the Great Pond floodplain area; consider opportunities for land acquisition, buffer expansion, and/or stringent development regulations; 2. Engage residents and contractors involved in small lot construction practices to apply erosion and sediment control practices; 3. Use high visibility of Great Pond to promote illegal dumping reform as a measure towards preserving natural resources of the STXEEMP; and 4. Replace culvert along Rt. 624 to improve chronic flood conditions, reduce DPW maintenance burden, and demonstration proper stream alignment and culvert sizing practices.
Madam Carty	<ol style="list-style-type: none"> 1. Prevent impacts from proposed Robin Bay Development and active construction of Pt. Elizabeth development by requiring stringent development regulations; 2. Conduct gut research on natural channels not currently impacted by development; Establish monitoring stations in key parts of the watershed to establish reference conditions for undeveloped watershed in the USVI, and to provide baseline information for comparison against data collected during urbanization efforts; and 3. Plan for increased inspection capacity and enforcement measures to accompany proposed development projects.
Solitude Bay	<ol style="list-style-type: none"> 1. Stabilize unpaved roads; 2. Engage local residents in restoration activities throughout the watershed and in their immediate neighborhoods; 3. Work with local businesses to reduce pollution through voluntary pollution prevention activities and through the installation of stormwater retrofits; and 4. Perform maintenance on high priority culverts.
Southgate	<ol style="list-style-type: none"> 1. Stop headcut migration of Adams’ Farm (East Gut) and stabilize nickpoints adjacent to roads and other infrastructure; 2. Engage local residents in restoration activities throughout the watershed and in their immediate neighborhoods; 3. Document the wetland restoration benefits of the recently completed embankment elevation project at Southgate Pond; and 4. Work with local businesses to reduce pollution through voluntary pollution prevention activities and through the installation of stormwater retrofits
Teague Bay	<ol style="list-style-type: none"> 1. Demonstrate road stabilization practices with TNC on Goat Hill Road; 2. Work with Reef Golf Course to stabilize gut while providing a golfing amenity; and 3. Install demonstration retrofits at St. Croix Yacht Club and a farm pond restoration project;
Turner Hole	<ol style="list-style-type: none"> 1. Retrofit and perform maintenance on existing stormwater facilities; 2. Improve response time to citizen complaints regarding sources of pollution; 3. Engage residents and contractors involved in small lot construction practices to apply erosion and sediment control practices; and 4. Stabilize unpaved roads.

Table 14. Example Metrics for Evaluating Progress towards Meeting Watershed Goals

Watershed Goal	Metrics
<p>1. Protect the marine resources of St. Croix’s East End Marine Park from the negative impacts of LBSP and maintain the rural character of the East End</p>	<ul style="list-style-type: none"> • Number of restoration actions listed in Sections 3 and 4 of this plan that were completed; • Measured improvements in water quality; • Length of unpaved road stabilized; • Reduced maintenance time required for roads and culverts; • Additional acres of conservation land; • Number of ESC violations and average response time; • Number of citizen complaints; • Number of existing septic systems inspected and/or replaced; • Number of beach closures; • Area of impervious cover treated by retrofit projects;
<p>2. Engage local residents and businesses in watershed stewardship activities</p>	<ul style="list-style-type: none"> • Dollars spent on education and outreach; • Number of volunteers participating in outreach activities; • Number of dumpsters missing tops/covers; • Number of downloads from education website; • Number of businesses enrolled in STXEEMP-Friendly Business Program; and • Number of certified Clean Marina programs.
<p>3. Demonstrate restoration actions that can be applied throughout the USVI.</p>	<ul style="list-style-type: none"> • Installation of demonstration restoration projects; • Number of attendees participating in site visits/workshops to discuss retrofit and other restoration projects; • Inclusion of design products in Territorial-wide reference documents or design manuals.

Appendices

Appendix A

Methods for Estimating Pollutant Load Reductions and Ranking Projects

1.0 Estimating Pollutant Loads

The Watershed Treatment Model (WTM) was developed by the Center for Watershed Protection as a planning-level spreadsheet model used to estimate pollutant loading (nutrients, sediment, and bacteria) under current watershed conditions, and to evaluate the effects of proposed structural and non-structural management practices identified during field assessments on current pollutant loads. The model can also account for the influence of existing management practices and evaluate the effects of future development on pollutant loads. Unless otherwise noted, this analysis uses default land use coefficients, pollutant event mean concentrations (EMCs) and loading rates for primary and secondary sources, as well as reduction efficiencies for structural and non-structural BMPs. It should be noted that a number of these values should be adapted to the USVI if absolute numerical loads are desired, but for comparative purposes, the default values are deemed appropriate when consistently applied across watersheds.

1.1 Existing Load Assumptions

The following important assumptions and input variables were used for establishing existing loads:

1. The primary input into the WTM is land use and the 2003 UVI/DPNR GIS land use layer was used to generate acres per land use category for this analysis. The USVI land use layer for the East End is incomplete and should be updated to better reflect on the ground conditions. No modifications to the existing land use maps were made for this analysis, except for the addition of paved and unpaved roads that were added to the model as separate land use categories. Table 1 summarizes watershed acres per land use category used in the WTM. Where USVI and WTM land use categories differed, procedures used in the 2007 North Shore TMDL were followed, including:
 - Hotels (USVI) are represented by Multifamily land use (WTM)
 - Parks & Open Space lands use (USVI) are represented by Rural lands (WTM)
 - Public Facilities and Waterfront/Marina areas (USVI) are represented by Commercial/Retail lands (WTM)
 - Undeveloped areas (USVI) are represented by Forest lands (WTM)

Table 1. Watershed Land Use Acres Used in Model Run

WTM Land Use	Erosion Potential	Watershed (acres)					
		GP	MC	SB	SG	TB	TH
Forested ¹	High	457.8	547.6	432.0	263.9	252.2	316.4
	Low	688.9	476.4	315.3	376.3	154.4	113.8
Rural ²	High	11.7		124.6	19.3	241.9	62.5
	Low	582.5		165.0	323.7	162.2	6.8
Residential (High)	High			6.9	17.8	7.1	
	Low			1.4	91.0	3.0	
Residential (Low)	High	13.2	3.2	230.9		84.2	64.3
	Low	172.1	1.9	234.9	210.3	41.2	48.2
Residential (Medium)	High					6.4	14.5
	Low			16.0		3.0	7.4
Multifamily ³	High			3.3			12.2
	Low	7.4		23.2	10.0		12.0
Commercial ⁴	High					8.8	
	Low					7.9	
Paved	High	9.4	1.7	22.1	16.9	18.8	13.1
	Low	32.9	9.0	27.8	36.6	15.3	36.5
Unpaved	High	0.7	1.2	16.8	1.9	8.5	3.0
	Low	9.6	2.3	20.7	8.2	6.2	3.2
Water		13.5			22.7		
Total		1999.7	1043.2	1640.9	1398.4	1021.1	713.9

¹ Forested (WTM) land use includes Undeveloped Land (USVI); roads and any missing land use acres were subtracted from undeveloped lands totals to reach equivalent total watershed acres
² Rural (WTM) land use includes Agricultural (USVI) and Open Space/Parks (USVI)
³ Multifamily (WTM) includes Hotels/Resorts (USVI)
⁴ Commercial (WTM) includes Public Facilities (USVI) and Marinas (USVI)

2. Impervious cover estimates for each land use category were based on WTM default values, and adjusted based on information presented in Finney, et al (2008). The total watershed impervious area in the model was compared to the existing DPNR impervious cover data for each watershed and assumed acceptable if they fell within 10% of DPNR value. Table 2 summarizes the impervious coefficients used.
3. An average annual rainfall of 37 inches was used to estimate runoff volumes. Soils are based on 2008 USDA SSURGO data for the USVI (Table 3).

Table 2. Impervious Cover Coefficients Used in Model Run

Category Imperviousness	IC Coefficient Ranges*	Used in WTM
major paved roads	50-100%	100% paved, 90% unpaved
commercial/industrial land	35-85%	72%**
high density residential	35-65%	40% HDR; 44% resorts (multifamily)
medium density residential	20-38%	25%
low density residential	5-20%	12%**
agricultural land/golf course	2-7%	0% rural
urban open land	3%	0% rural
forested land	0-7%	0% undeveloped
* Presented in Finney et al. (2008)		
** WTM default		

Table 3. Percentage of HSG Soil Group in each Watershed

Watershed	Hydrologic Soil Group			
	A	B	C	D
Great Pond Bay	0%	25%	63%	12%
Madam Carty	1%	58%	38%	3%
Solitude Bay	1%	59%	36%	4%
Southgate	1%	31%	60%	7%
Teague Bay	0%	68%	27%	4%
Turner Hole	0%	70%	24%	5%

4. Default pollutant event mean concentrations (EMCs) in runoff from various land uses were derived from values from the National Stormwater Quality Database (NSQD), which is a summary of national stormwater data from over 200 jurisdictions nationwide (Pitt et. al., 2003). Tables 4 and 5 show the values used in this analysis, some of which were adjusted as follows:

- High and low TSS and TP EMC values were assigned for each land use category based on designated “High” or “Low” Erosion Potential areas. WRI/NOAA (2005) applied the N-SPECT model in 2005 in USVI and Puerto Rico watersheds by using slope, rainfall, soil, and an erodibility factor to determine areas of relative erosion potential (see Figure 1). The re-interpretation of this data specifically for this analysis sets the threshold for “High” Erosion Potential based on the relative value of 1000 for the East End watersheds using WRI’s “Vulnerability to Erosion” dataset.
- Loading rates for undeveloped and rural lands were based on rates used in the 2007 North Shore TMDL (adjusted to account for annual rainfall variation by a factor of 1.1).

Figure 1. Using Erosion Potential Analysis to Assign High and Low EMCs and Loading Rates for Primary Sources in the WTM

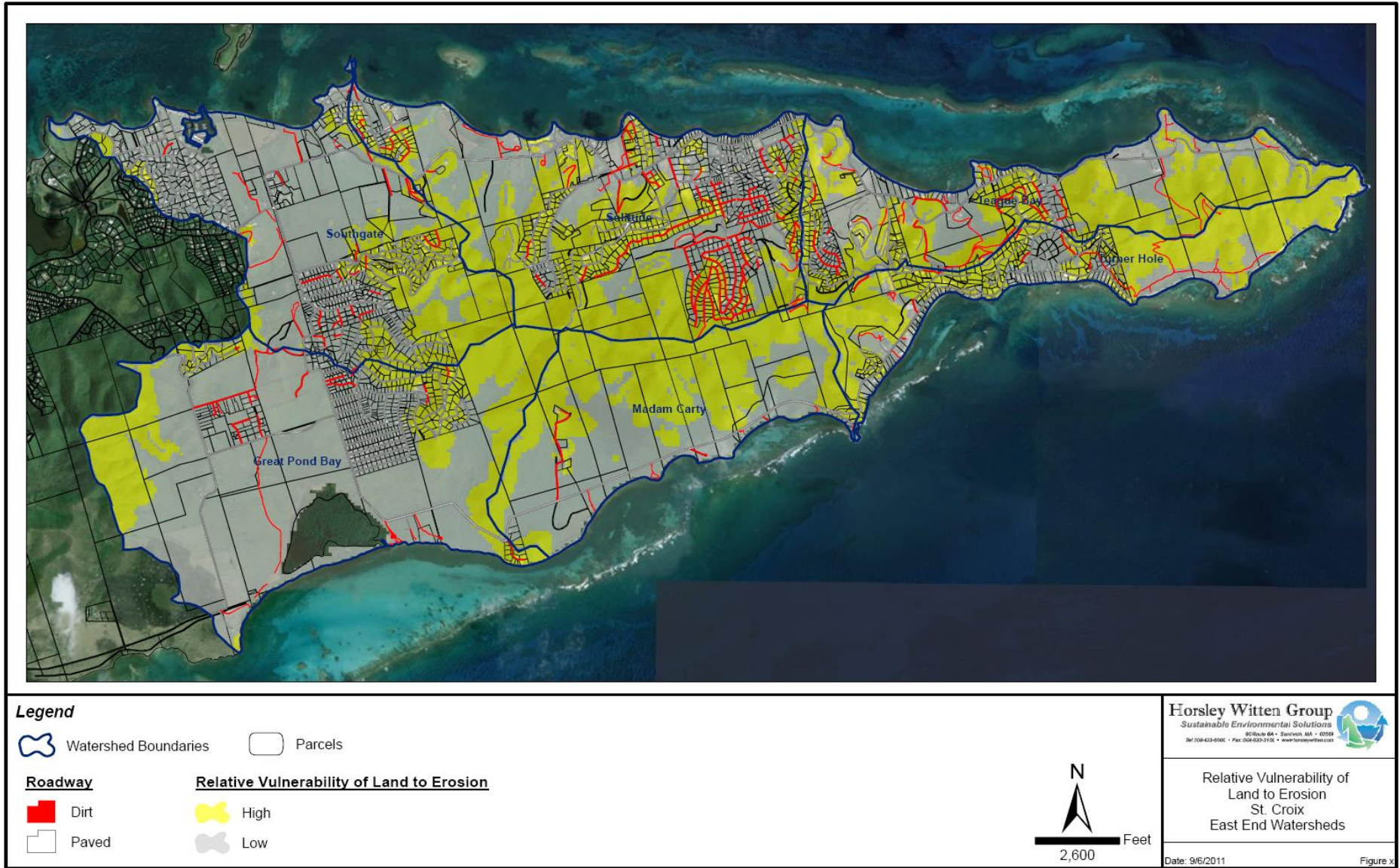

- High and low TSS loads from unpaved roads were derived from work done by Carlos Ramos-Scharron (2007) in Puerto Rico (see Figure 2 below). These values are lower than loads estimated in Fish Bay, USVI, and should be considered on the low end. More data would need to be collected and more thorough analysis conducted to accurately estimate sediment loads from roads in the East End (per com. Ramos-Scharron, 2011).

Figure 2. High and Low values selected from points along the sediment production curve for unpaved roads as slope increases based on data from La Parguera (Ramos-Scharrón, 2007). These estimates should be considered conservative for application in the East End given the high vehicular usage of the unpaved network.

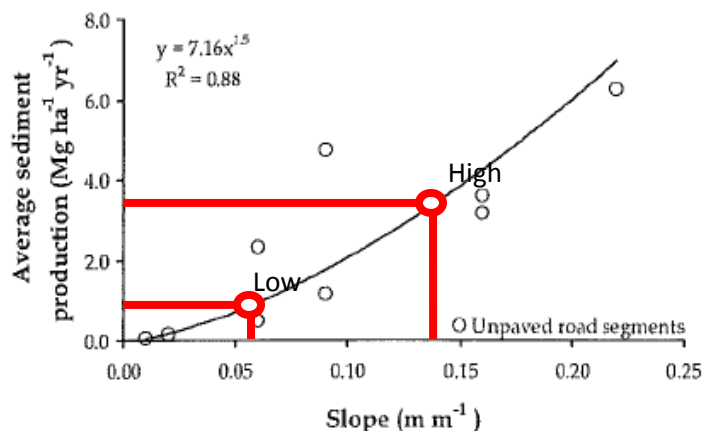

Table 4. Pollutant Event Mean Concentrations (EMC) in Stormwater Runoff Used in Model Run

WTM Land Use	Erosion Potential	EMC			
		(mg/L)			(MPN/100ml)
		TN	TP	TSS	Fecal Coliform
Residential ⁺	High	2.1	0.31	59	7,000
	Low		0.27 ⁺	49	
Commercial ⁺	High	2.1	0.27 ⁺	59	4,200
	Low		0.22	43	
Paved ⁺	High	2.3	0.27 ⁺	99	1,700
	Low			59 ⁺	
Unpaved	High	2.3	0.25	588 ⁺⁺	1,700
	Low			167 ⁺⁺	

EMCs are based on median concentrations for each specific land use type as reported in the NSQD (2004) unless otherwise noted.

⁺ Median value across all land types in NSQD (2004)

⁺⁺ Conservative TSS EMCs back calculated from Ramos-Scharron (2007) average sediment production in La Parguera for roads, where Low value is equivalent to a median annual loading rate at 30 inches of rainfall a year of 896 lbs/acre/yr (1 Mg/ha), and high is of 3136 lbs/acre/yr at 3.5Mg/ha/yr (15% slope). These rates are an order of magnitude lower than production rates measured on St. John.

Table 5. Annual Loading Rates Used in the WTM

WTM Land Use	Erosion Potential	Assumed Loading Rate			
		(lbs/acre/yr)			(#billion/acre/yr)
		TN	TP	TSS	FC
Forested	High	2.5	0.2	78 ⁺⁺⁺	12
	Low			50 ⁺⁺	
Rural	High	4.6	0.7	127 ⁺	39
	Low			100	
Water	n/a	12.8	0.5	155	--

Rates are based on default loading rates in the WTM, unless otherwise noted.
⁺ Loading rate for rural lands used in 2007 North Shore TMDL (adjusted from 40 inches/yr rainfall)
⁺⁺ Uses half of rural TSS loading rate for forested area.
⁺⁺⁺ High value uses same rate adjustment factor of 1.27 as rural load.

- Secondary sources of pollutants were limited to gut erosion, marina berths, septic discharges, livestock, and waste water discharges from package plants. Tables 6A and 6B summarize the data assumptions used for these secondary sources. Septics were estimated based on the number of single family dwelling units determined by an aerial mapping count. DPNR and local package plant manager provided estimates of daily flow and average effluent concentrations for wastewater point discharges. Estimates of marina berths were based on direct conversation with Green Cay Marina operators and a count of vessels moored at the St. Croix Yacht Club using 2007 aerial images. Since goats and horses are not default values in the WTM, estimates for livestock were applied uniformly across the three watersheds and modeled as 30 cattle.

The WTM has limited capacity to model stream erosion in non-urban settings. Most of the guts in the East End are not typical perennial, urban streams; therefore the model requires the user to assign a broad level of erosion, effectively assigning an allocation of total estimated load to stream erosion (e.g., we assume 1/3 of the TSS load is from stream erosion), which the model then backs into based on the loads estimated from other primary and secondary sources. We assigned an erosion level to each watershed based on a combination of factors including: miles of guts, field observations, and number of candidate gut restoration projects identified in each watershed.

- Existing treatment options were limited to marina pumpouts and existing stormwater facilities. No non-structural practices such as buffer enhancement, erosion control, pet waste programs, street sweeping, reduced lawn fertilization, etc were incorporated into the model at this time.

Table 6A. Secondary Sources and Existing Management Assumptions

Watershed	Secondary Sources				Existing Management	
	% of total watershed storm load allocated to gut erosion*	Estimated # dwellings	Estimated # of boats	Live-stock	Marina Pumpouts	BMPs**
Great Pond Bay	10%	196	-	No	-	0
Madam Carty	5%	7	-	No	-	0
Solitude Bay	25%	372	-	Yes	-	0
Southgate	25%	333	154	Yes	1	0
Teague Bay	15%	91	30	Yes	0	0
Turner Hole	15%	94	-	No	-	3 dry detention basin

* Due to lack of available data, this value is assigned based on best professional judgment from field observations and serves as a placeholder.
 ** BMPs are located at the Divi Casino, Divi Hotel, and Villa Madeline

Table 6B. Point Source Discharge from Waste Water Package Plants

Treatment plant	Type	Average Flow (GPD)	Effluent TSS (mg/L)	Effluent TP (mg/L)	Effluent TN (mg/L)
Chenay Bay Resort	Extended Aeration W/disinfection	2,883	8.3	5.0	5
Cheeseburgers/Southgate Condos	Activated Sludge W/disinfection	2,051	17.9	5.0	3.48
Divi Hotel and Condominiums	Secondary Treatment	57,000	30	5.0	40
Reef Golf/Condos (Reef Assoc. II)	Secondary Treatment	32,000	30	5.0	40
Coakley Bay Condos	Secondary Treatment	15,000	30	5.0	40
Green Cay Marina (St. Croix Financial Center)	Secondary Treatment	6,000	30	5.0	40

Estimates provided by Mirko Restivic and Benjamin Keularts (DPNR)

1.2 Future Load Assumptions

Future development in the WTM often uses Zoning information. The zoning information available in the USVI is outdated and not ideal for WTM application. Modeling for future development in this analysis was based on best professional judgment and is based on the following assumptions:

1. Two new resorts/hotels that result in the conversion of 25 existing agricultural land use acres and 50 undeveloped acres to resort/hotel (“multifamily” in the WTM) acres.

2. Assume that both new developments have wastewater systems that meet the assumptions used for the existing Divi site (see Table 6B)
3. Existing stormwater management practices at the Great Pond site is considered either non-effective and not accounted for since proposed plans were not available at this time. Stormwater management at the Robin Bay site in Madam Carty includes wet ponds, constructed wetlands, and bioretention facilities.
4. The future development tab in the WTM spreadsheet was not used, rather a new model was run reflecting changes in land use.

1.3 Load Reduction Assumptions

Potential load reductions are modeled based on the implementation of only three restoration activities: road stabilization, gut repair, and stormwater retrofitting. No programmatic or non-structural improvements are considered at this time. Modeling assumptions include:

1. Stabilization of unpaved roads was modeled as a change in the EMC for existing unpaved roads to the lower EMC associated with paved roads. Where necessary, individual road projects were evaluated separately and total surface area (generated in GIS or by assuming average road width of 20 ft) divided between high and low erosion potential areas.
2. Gut restoration projects were modeled only for Southgate and were assigned a reduction consistent with shifting from 25% to 15% of TSS contribution to the total watershed storm load.
3. Stormwater retrofits were modeled as management practices applied to existing conditions (rather than using the revised retrofit spreadsheet provided in the model). Total drainage area and impervious estimates for each retrofit practice were used (see Table 9) and adjusted to reflect a 75% capture efficiency. Removal efficient discount values for maintenance and design criteria were set at the highest level available. Default pollutant removal efficiencies provided in the WTM were used for this analysis (Table 7). Only TSS reductions were evaluated.

Table 7. WTM default BMP Pollutant Removal Efficiencies

BMP	Efficiency (%)			
	TN	TP	TSS	Bacteria
Dry Water Quantity Pond	5%	10%	10%	0%
Dry Extended Detention Pond	10%	15%	55%	0%
Wet Pond	30%	50%	80%	70%
Wetland	25%	50%	75%	80%
Filters	30%	60%	80%	80%
Green Roof	45%	45%	80%	0%
Rooftop Disconnection	25%	25%	85%	0%
Permeable Pavement	60%	60%	75%	0%
Grass (open) Channel	30%	25%	60%	0%
Dry Swale (bioswale, WQ swale)	55%	50%	85%	0%

BMP	Efficiency (%)			
	TN	TP	TSS	Bacteria
Wet Swale	25%	20%	70%	0%
Raintanks and Cisterns	40%	40%	40%	0%
Soil Amendments	50%	50%	75%	0%
Sheetflow to Open Space (excluding riparian buffers)	50%	50%	85%	0%
Grassed Filter Strips	50%	50%	85%	0%
Bioretention	65%	55%	85%	90%
Infiltration Practices	55%	65%	95%	85%

2.0 Project Ranking and Prioritization

Table 8 provides the ranking criteria used to help prioritize candidate projects. Scoring criteria and weights are assigned to 11 different metrics. Specific feedback from local residents and agency staff was used to establish project ranking criteria and weights. The following discussion points from July 2011 meetings in particular were used to revise the ranking methodology:

- While important, priorities should not be driven by impaired water status given the limitations of the water quality monitoring program;
- Private vs. publicly-owned lands, while typically an important implementation factor are not as important in STX given the existence of funding opportunities for private/rural properties and DPW's willingness to support road and drainage projects on private networks;
- Cost is not as big of a factor as improvement in water quality;
- The most important factor is pollutant load reduction; and
- Improved safety (of the road network) is important to local residents.

A brief description of the ranking metrics is provided below:

- Impaired waters are based on the DPNR 2010 Integrated Waters Report and are shown in Figure 2.15 of the Existing Conditions Report.
- Drainage areas to each candidate project were delineated using GIS and based on field notations. Impervious cover within each drainage area was estimated using the impervious cover layer provided by DPNR. Minor modifications were made to this estimate as observed in the field.
- To determine pollutant removal potential, we used a combination of the WTM default removal efficiencies provided in Table 7 and a conservative estimate of how much area actually could be captured and managed given practice space limitation. In addition gut stabilization practices assume a pollutant removal 70% reduction in TSS and nutrients

based on recent studies in the Chesapeake Bay (Medina and Curtis, 2011). Road stabilization projects are assumed to reduce pollutant loads by 80%.

- To determine relative cost estimates, generally accepted cost estimates derived by the Center for Watershed Protection were used where feasible (CWP ranking spreadsheet, 2010). Table 8 shows the assumed cost/cubic foot treated for various practices and provides the sources of this information. Using this table, plus best professional judgement practices were loosely considered low cost if unit costs were less than or equal to \$10/cf; medium if between \$11 and \$25/cf, and high if \$25/cf. This estimate was supplemented with site-specific knowledge related to site constraints and complexity of design. For planning level cost estimates for more detailed concepts, these unit costs will actually be increased by at least 30% given the additional costs for material and labor in the USVI.
- Projects scored highly if they were determined to provide a public benefit such as reduced road flooding. High scoring projects also include those located on public lands or on private property that was in a highly visible location or open to volunteer participation by residents or others.
- Where the identification of an implementation partner or management entity has occurred or is considered easy to determine (e.g., Homeowners association, business owner, designated agency, or site facilities manager) , then the management feasibility was considered high. If there are no easily identifiable partners, then the project ranked low.
- Site constraint factors may include soils, utilities, access issues, ownership issues, limitations on space, and impacts to existing natural areas.

Similar factors were used to rank gut and road restoration projects with the exception of the following additional metrics:

Guts

- Length of gut restoration—on a scale of 1-5

Roads

- Traffic volume—on a scale of 1-5 with 1 being low
- Load reduction from road stabilization—on a scale of 2-5 based on number of acres stabilized and severity of existing condition
- DPW priority—on a scale of 1-5 based on whether there is a current or potential threat to public roads/culverts
- Relative cost—on a scale of 1-5 based on the # of structures and extent of effort

Tables 10A-10C are the ranking spreadsheets and show which projects were grouped into High, Medium, and Low implementation priorities.

Table 8. Project Ranking Factors

Factor	Description	Scoring Criteria and Numerical Range		Weight
Water Quality Benefits	Areas drains to designated impaired waters	yes	5	5
		no	0	
	Total drainage area to project	≥ 10 ac	5	5
		≥ 5 ac	3	
		< 5 acre	2	
	Total impervious cover to be managed (retrofit only)	> 5 acre	5	5
		≥ 1 acre	3	
		< 1 acre	2	
	Pollutant removal potential (TSS) based on pre-determined BMP removal efficiencies and volume managed	> 85% or most of WQ volume managed	10	10
≥ 75% or some of WQ volume managed		6		
<75% or not much of WQ volume managed		3		
Other Public Benefit	Flood prevention, drainage improvement; or transportation safety	High	5	5
		Med	3	
		Low	2	
	Public Awareness: Visibility and potential for public education and involvement	High	5	5
		Medium	3	
Low		0		
Cost	Relative Construction Cost Based on the Type of Practice	Low cost	2	2
		Med cost	1	
		High cost	0	
	Potential funding source for early implementation	High	3	3
		Low	0	
Management Feasibility	Identified party for implementation and long-term management	Yes	5	5
		Maybe	2	
		Not really	0	
Site Constraints	Includes conflicts with existing natural areas; soils; utilities; limited space; and construction and maintenance access	None	5	5
		Minor or Unknown	2	
		Major	0	
			Retrofit Total	50

Table 9. Unit Costs for Various Practices (from Center for Watershed Protection)

Unit Costs				
Derived From: Urban Subwatershed Restoration Manual (USRM) 3, Appendix E, Table E.4, Median Cost (except where noted)				
Practice	Qualifier	Unit Cost (\$/cf treated)	Notes	Ranking Factor
Green Roof	Extensive green roof	\$170.00	Appendix E -- assumes "Extensive" green roof system	High
Rooftop Disconnection	100-900 ft ² of rooftop, 1" of rainfall, \$50 per disconnection	\$1.00	Derived from programs evaluated in Portland, OR	Low
Rain Tank/Cistern	Cistern or larger storage device	\$15.00	Appendix E	Medium
Soil Amendments		\$7.50	Appendix E	Low
Filter Strip	Width = 25 to 75 ft	\$6.00	Appendix E	Low
Permeable Pavement		\$30.00	Derived from \$10 per sq ft from Hathaway & Hunt (2006)	High
Grass Channel	3 - 5% of CDA	\$6.25	Half of water quality swale, needs updating. Can also use \$15/lf (WDNR, 2003)	Low
Bioretention	> 0.5 acre treated	\$20.00	Derived from actual bids in Virginia from consulting firm (in 2010)	Medium
Rain Garden	< 0.5 acre treated	\$10.00	Assumed as half of cost of bioretention due to lack of underdrain, gravel, etc.	Medium
Stormwater Planters		\$26.00	Appendix E	High
Infiltration	3 -- 5% of CDA	\$15.00	Appendix E, Table E.4. Can also use \$10 per sf (WDNR, 2003)	Medium
Dry Wells/French Drain		\$11.50	Appendix E	Medium
Dry Swale	3 -- 5% of CDA	\$12.50	Appendix E, Table E.4	Medium
Wet Swale	3 -- 5% of CDA	\$12.50	Assumed to be same as Dry Swale	Medium
Extended Detention Pond	2 -- 4% of CDA	\$3.00	Appendix E, Table E.4. Can also use \$3800 per impervious acre.	Low
Filtering Practice	3 -- 5% of CDA	\$20.00	Appendix E, Table E.4. Assumes structural filter.	Medium
Constructed Wetland	3 -- 6% of CDA	\$7.00	Appendix E. Can also use \$2900 per impervious acre.	Low
Wet Pond	3 -- 5% of CDA	\$5.00	Appendix E. Can also use \$8350 per impervious acre.	Low
Regenerative Design				
Other Practices (not included in remainder of spreadsheet)				
Catch Basin Insert		\$4.00	From EPA Website: http://cfpub.epa.gov/npdes/stormwater/menuofbmps/index.cfm?action=browse&Rbutton=detail&bmp=77	Low
Downspout Disconnection to Rain Barrel	1 or several 55-gallon barrels	\$25.00		Medium
Impervious Cover Removal		\$20.00		Medium
Reforestation/Tree Planting/Native Landscaping		\$5.00	Based on guidance in the Chesapeake Bay Riparian Handbook and City of Portland Stormwater Management Manual	Low
References				
City of Portland Stormwater Management Manual is available on line at: http://www.portlandonline.com/BES/index.cfm?c=47952				
Chesapeake Bay Riparian Handbook is available online at: http://www.chesapeakebay.net/pubs/subcommittee/nsc/forest/sect06.pdf				
Runoff Reduction Method Technical Memo is available online at: http://www.cwp.org/Resource_Library/Center_Docs/SW/RRTechMemo.pdf				
Urban Subwatershed Restoration Manual No. 3: Urban Stormwater Retrofit Practices is available online at: http://www.cwp.org/formmaker/Download-Form_RedirectFormPage.html				
Wisconsin Department of Natural Resources (WDNR). 2003. <i>Rain gardens: A how-to manual for homeowners</i> . Madison, WI.				
Hathaway, J. and W. Hunt. 2006. "Stormwater BMP Costs." North Carolina State University. Department of Biological and Agricultural Engineering. Raleigh, NC.				
List of Acronyms				
CDA	Contributing Drainage Area			
cf	cubic foot/feet			
sf	square foot/feet			

Table 10A. Retrofit Project Ranking

Rank	RETROFIT			Drainage Area (acres)	Impervious Area (acres)	Water Quality					Public Benefit		Cost		Mngmt Feas.	Site Constraints	Total
	Site ID	Location	Description			Impaired water	Drainage Area to Site	Impervious Area to Site	TSS Removal and volume managed	Length	Other	Public Awareness	Construction Cost	potential funding			
Low	SG-R-3A	Green Cay Marina	oil/grit separator	0.8	0.6	5	2	2	3		0	0	1	0	5	2	20
	SG-R-3C	Green Cay Marina	oil/grit separator	0.4	0.3	5	2	2	3		0	0	1	0	5	2	20
	SB-R-8	Candle Reef II	cul-de-sac island bioretention	0.5	0.3	0	2	2	6		1	1	1	0	5	4	22
	SB-R-5A	Coakley Bay Condo	bioretention	0.7	0.4	0	2	2	8		1	1	2	0	5	2	23
	SB-R-5B	Coakley Bay Condo	bioretention	0.4	0.2	0	2	2	8		1	1	2	0	5	2	23
	SB-R-2A	Blue Water Terrace	bioretention	1.0	0.60	0	2	2	6		0	2	2	0	5	4	23
	SB-R-2B	Blue Water Terrace	bioretention	1.0	0.60	0	2	2	6		0	2	2	0	5	4	23
	SB-R-7A	Carden Beach	cul-de-sac island bioretention, forebay maintenance, and outlet stabilization	1.7	0.2	0	2	2	8		3	3	2	0	3	2	25
	SB-R-4	Ziggy's	swale	5.8	1.5	0	3	3	6		2	5	1	0	5	0	25
	SG-R-2B	Southgate Condos	bioretention in rear	0.4	0.3	5	2	2	6		0	0	2	0	5	3	25
	SB-R-7	Carden Beach	shallow constructed wetland	3.1	0.5	0	2	2	10		3	2	2	0	5	0	26
	SG-R-1	Cheeseburgers	bioswale	0.9	0.6	3	2	2	5		1	5	1	3	3	2	27
	SB-R-6	Coakley Bay Condo	roadside swale in front of Coakley Bay Condos (includes fixing trail and culvert)	19.4	4.0	0	5	2	6		5	3	1	3	2	1	28
	TH-R-3C	Divi Hotel/Resort	permeable pavement in parking lot	0.4	0.3	5	2	2	10		2	2	0	0	2	3	28
Med	TH-R-4	Hotel Renovation	bioretention in parking lot	0.4	0.3	5	2	2	8		2	3	1	0	5	2	30
	TH-R-2C	Divi Casino	landscape island rain garden in Divi parking lot	0.6	0.6	5	2	2	5		2	3	2	1	5	3	30
	TH-R-2B	Divi Casino	landscape island rain garden in Divi parking lot	0.3	0.3	5	2	2	5		0	3	2	1	5	5	30
	SG-R-20B	Chenay Bay	linear bioretention in parking lot	0.4	0.4	5	2	2	6		5	2	1	0	5	2	30
	SG-R-3B	Green Cay Marina	bioretention	0.4	0.2	5	2	2	8		2	3	1	0	5	2	30
		Villa Madeline	maintenance and expansion of existing detention practice	6.7	3.7	5	3	3	8		4	1	2	0	3	2	31
	SG-R-2A	Southgate Condos	rain garden at Entrance	0.3	0.2	5	2	2	8		0	2	2	1	5	4	31
	SG-R-4	Green Cay Marina	swales in roadside median	9.9	2.6	5	5	3	6		3	3	1	2	3	0	31
	TH-R-3B	Divi Hotel/Resort	rain garden in parking lot	0.6	0.5	5	2	2	6		3	3	2	1	5	3	32
	TH-R-3D	Divi Hotel/Resort	rain garden in parking lot	0.4	0.3	5	2	2	6		3	3	2	1	5	3	32
TB-R-2A	STX Yacht Club	constructed wetland forebay and formalized swale	0.8	0.5	5	2	2	8		3	4	1	2	3	2	32	
SG-R-5	Tamarind Reef	shallow bioretention near tennis courts	0.3	0.1	5	2	2	10		2	3	1	0	5	2	32	
High	SB-R-3	Seven Flags	stepped detention behind homes on Seven Flags Rd.	54.1	7.4	0	5	5	10		5	2	0	3	2	3	35
	TB-R-2B	STX Yacht Club	rain garden	86.5	9.8	5	5	5	5		2	4	2	2	3	2	35
	SB-R-1A	Fire Station	rain garden in front	9.7	1.9	0	5	3	6		3	5	2	3	5	3	35
	TH-R-3A	Divi Hotel/Resort	retrofit existing dry detention basin	11.6	3.7	5	5	3	6		5	2	2	0	5	2	35
	TH-R-1	East End Bay Trail	bioretention at East End Bay Trailhead parking lot	1.4	0.3	0	2	2	10		5	5	2	3	5	2	36
	SG-R-20A	Chenay Bay	rain garden at restaurant	0.2	0.1	5	2	2	10		2	3	2	3	5	3	37
	SB-R-1B	Fire Station	dry swale, cistern, and dumpster area on side	2.5	2.3	0	2	5	8		5	5	1	3	5	3	37
	TB-R-3A	Reef Golf Course	ED wet pond	27.9	3.1	5	5	3	6		5	2	2	0	5	5	38
	TB-R-3B	Reef Golf Course	constructed wetland/forebay	205.1	29.9	5	5	5	10		2	5	1	3	3	0	39
	TH-R-2A	Divi Casino	retrofit existing dry detention basin	66.5	13.7	5	5	5	6		4	3	2	0	5	5	40

Table 10B. Gut Restoration Project Ranking

Location	Description	Water Quality					Public Benefit		Cost		Mngmt Feas.	Site Constraints	Total	Priority
		Impaired water	Drainage Area to Site	Impervious Area to Site	TSS Removal and volume managed	Length	Other	Public Awareness	Construction Cost	potential funding				
West Gut behind Cheeseburgers	isolated bank stabilization	5	5	1	3	0	0	0	2	0	0	5	21	Low
West Gut on Schusters property	NCSU restoration plan	5	5	2	5	0	1	0	0	3	2	0	23	Low
Sally's Fancy	Riprap stabilization at head cut, install curb and paved flume	0	5	1	5	0	3	5	2	5	2	3	31	Medium
East Gut Adams Farm headcut	Stabilize headcut and overland flow path	5	5	5	10	3	5	0	0	5	2	5	45	High
Gut at Reef Golf Course	Divert small storms, stabilize eroding banks, check dams to slow erosive velocities	5	5	5	5	3	2	3	0	3	4	5	40	High
	Total points possible	5	5	5	10	5	5	5	5	5	5	5	60	

Table 10C. Unpaved Road Improvement Project Ranking

Unpaved Road Improvements		Distance	Acres	Impaired Waters	Traffic volume	Potential load reduction	DPW priority	Cost	Funding Potential	Priority	
Project ID	Location										
SB-RC-1	Sierra Verde/Bajamar Rd	350 ft	0.2	0	2	2	0	4	0	8	Low
GP-RC-33	Unnamed Road off SouthShore	300 ft	0.1	0	2	2	4	3	2	13	Medium
SB-RC-8	Hope and Carton Neighborhood	3.6 miles	8.7	0	4	5	1	1	5	16	High
TB-RC-4	Goat Hill Rd.	1200 ft	0.6	5	1	3	0	3	4	16	
SB-RC-9	Seven Flags Rd.	1000 ft	0.5	0	3	5	5	1	3	17	
TB-RC-3	Ridge Rd. at Rt. 82	250 ft	0.1	5	3	2	2	4	1	17	
	Total points possible			5.0	5.0	5	5	5	5	30	

Appendix B

Watershed Management Maps

Great Pond Restoration Priorities Map
Great Pond Culvert Map

Madam Carty Watershed Map

Solitude Bay Watershed Restoration Priorities Map
Solitude Bay Culvert Map

Southgate Watershed Restoration Priorities Map
Southgate Culvert Map

Teague Bay Watershed Restoration Priorities Map
Teague Bay Culvert Map

Turner Hole Watershed Restoration Priorities Map
Turner Hole Culvert Map

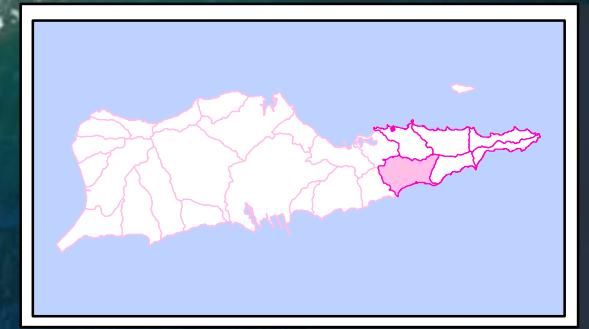

Legend

- Great Pond Bay Watershed
- Watershed Boundaries
- Parcels
- Estate Boundaries with Names
- Guts
- 20ft. Contours
- Roadway Type**
- Dirt
- Paved

Gut Restoration Projects

- High Priority
- Medium Priority
- Low Priority

Pollution Prevention Projects

- High Priority

Road Stabilization Projects

- High Priority
- Medium Priority
- Low Priority

Trail Stabilization Projects

- High Priority

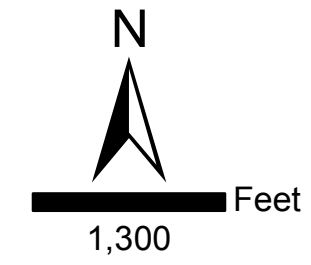

Horsley Witten Group
 Sustainable Environmental Solutions
 90 Route 6A • Sandwich, MA • 02563
 Tel: 508-833-6600 • Fax: 508-833-3150 • www.horsleywitten.com

Great Pond Bay Watershed -
 Project Ranking
 St. Croix
 East End Watersheds

Date: 9/19/2011 - mw

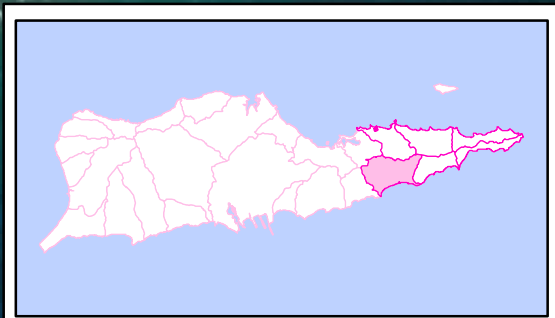
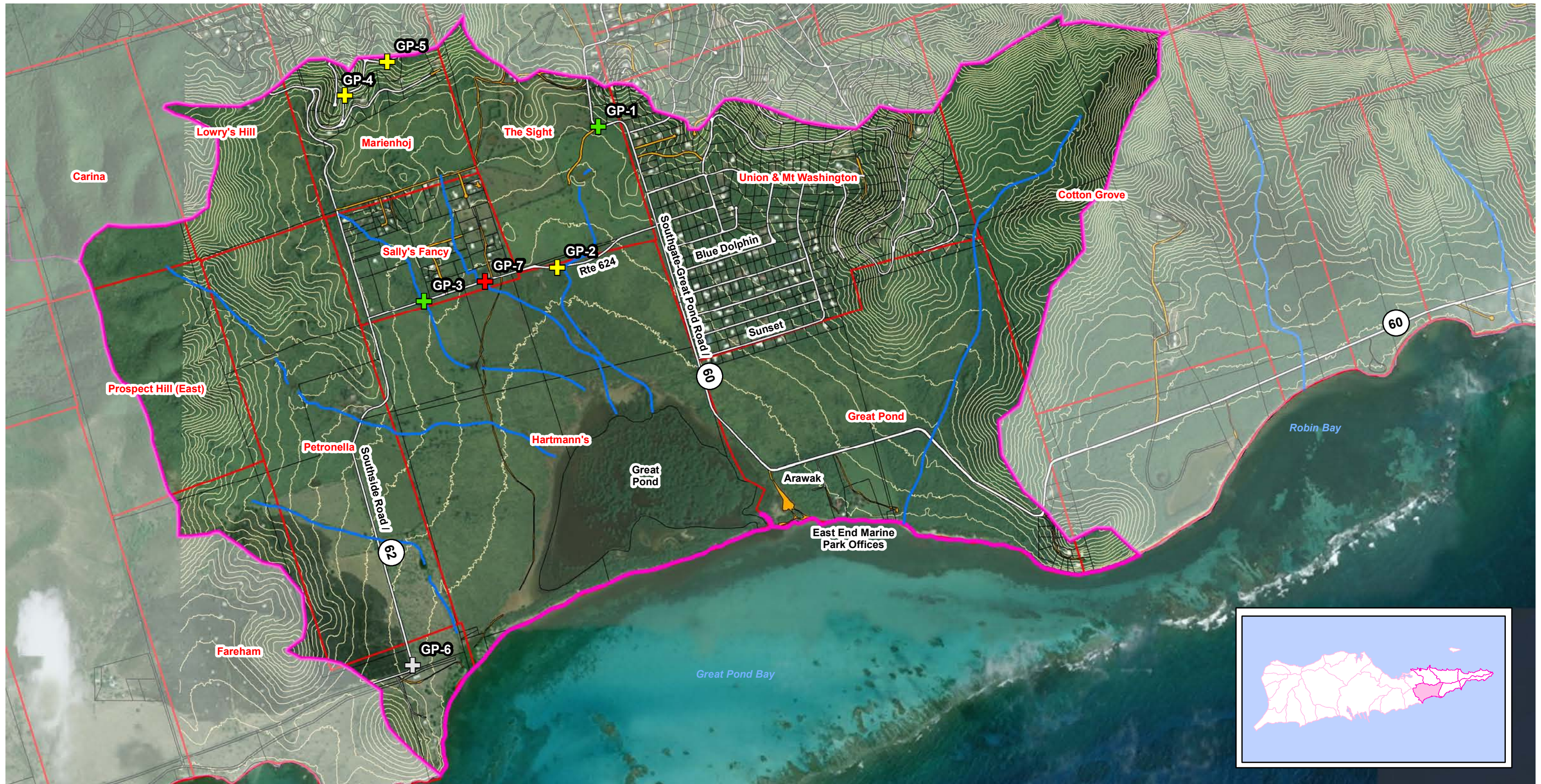

Legend

- Great Pond Bay Watershed
- Watershed Boundaries
- Parcels
- Estate Boundaries with Names

- Guts
 - 20ft. Contours
- Roadway Type**
- Dirt
 - Paved

Culvert Maintenance

- High Priority
- Medium Priority
- Low Priority
- Maintenance not needed at this time

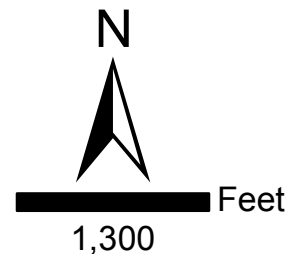







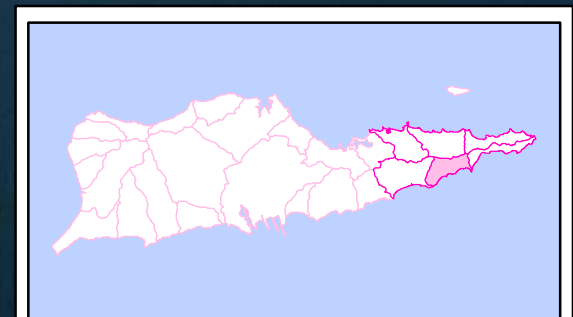
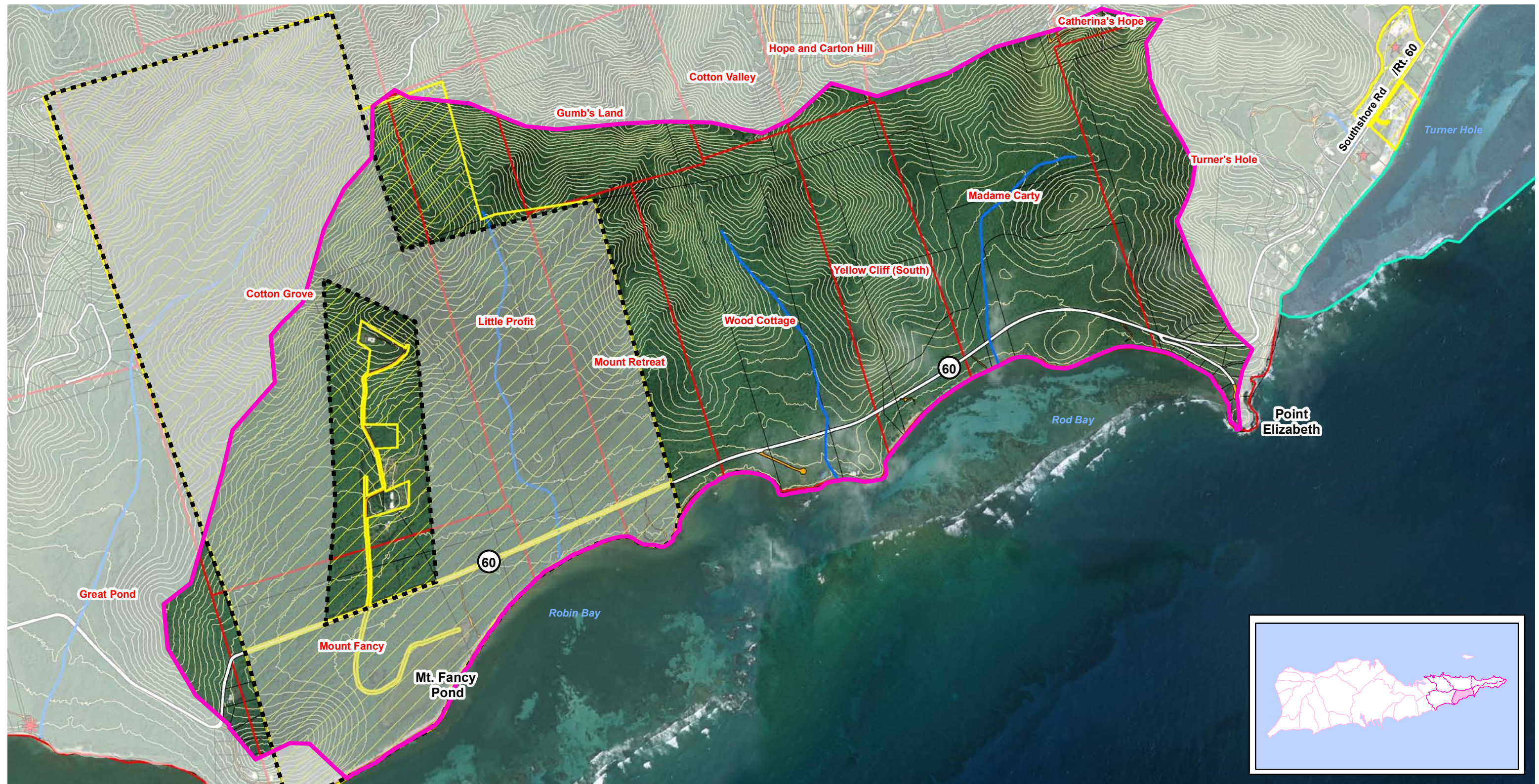

Horsley Witten Group
 Sustainable Environmental Solutions
 90 Route 6A • Sandwich, MA • 02563
 Tel: 508-833-6600 • Fax: 508-833-3150 • www.horsleywitten.com

**Great Pond Bay Watershed -
 Culverts
 St. Croix
 East End Watersheds**

Date: 9/19/2011 - mw



Legend

-  Madam Carty Watershed
-  Watershed Boundaries
-  Parcels
-  Estate Boundaries with Names
-  Guts
-  20ft. Contours
-  District 4 - High Density Zoning District
-  Potential Robin Bay Resort Development

Roadway Type

-  Dirt
-  Paved

* There are no Candidate Restoration Projects within the Madam Carty Watershed

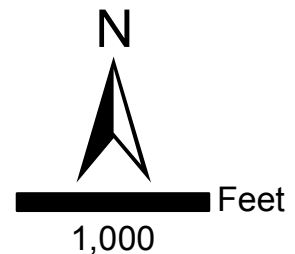

Horsley Witten Group
 Sustainable Environmental Solutions
 90 Route 6A • Sandwich, MA • 02563
 Tel: 508-833-6600 • Fax: 508-833-3150 • www.horsleywitten.com

**Madam Carty Watershed -
 Project Ranking
 St. Croix
 East End Watersheds**

Date: 9/19/2011 mw



Legend

- Solitude Watershed
- Watershed Boundaries
- Parcels
- Estate Boundaries with Names

- Guts
- 20ft. Contours
- Roadway Type**
- Dirt
- Paved

Retrofit Projects

- High Priority
- Medium Priority
- Low Priority

Pollution Prevention Projects

- High Priority

Road Stabilization Projects

- High Priority
- Medium Priority
- Low Priority

Trail Stabilization Projects

- High Priority

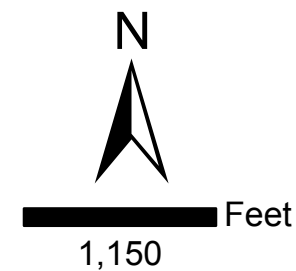

Horsley Witten Group
 Sustainable Environmental Solutions
 90 Route 6A • Sandwich, MA • 02563
 Tel: 508-833-8600 • Fax: 508-833-3150 • www.horsleywitten.com

Solitude Watershed - Project Ranking
 St. Croix
 East End Watersheds

Date: 9/19/2011 - mw

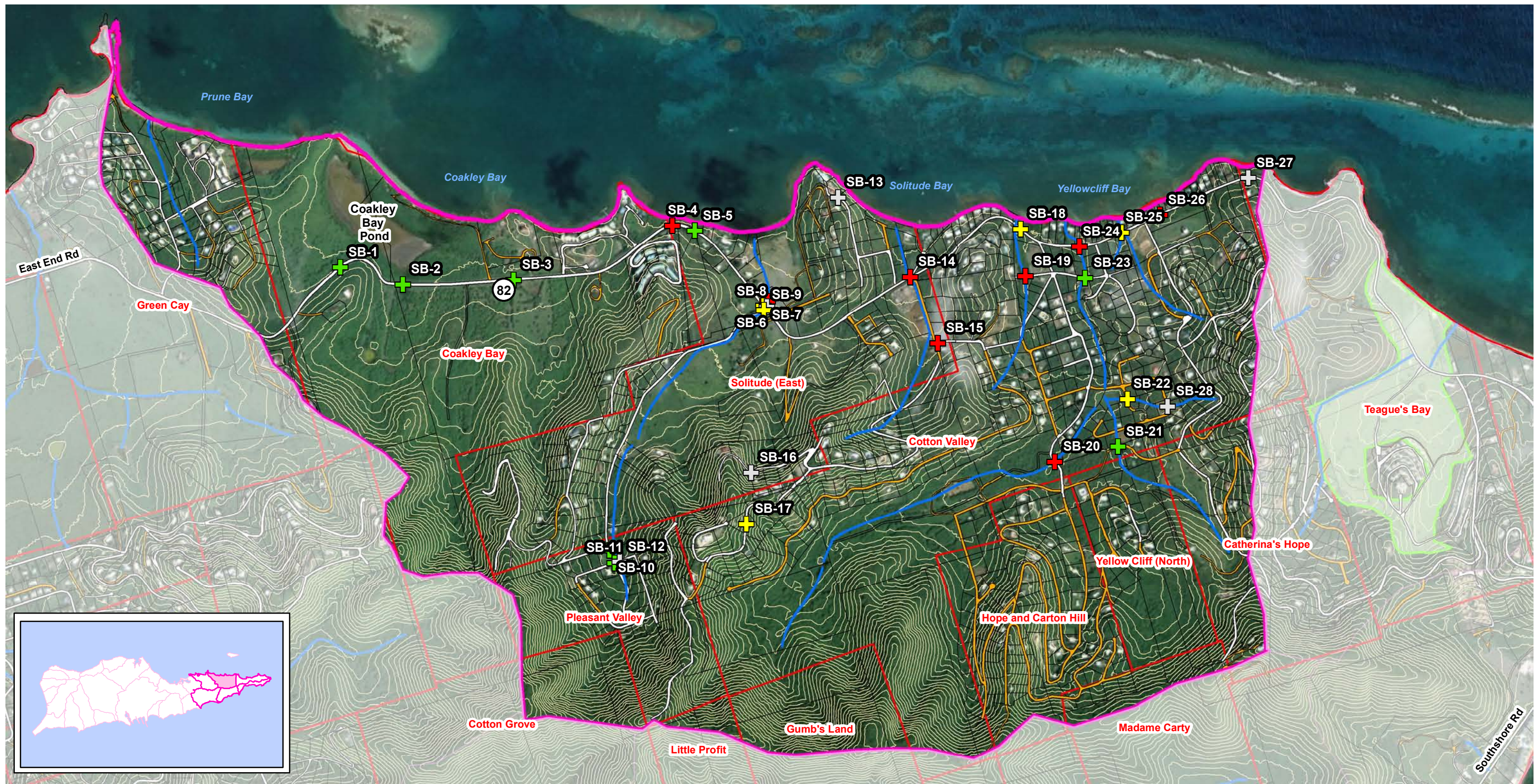

Legend

- Solitude Watershed
- Watershed Boundaries
- Parcels
- Estate Boundaries with Names

- Guts
- 20ft. Contours

Roadway Type

- Dirt
- Paved

Culvert Maintenance

- High Priority
- Medium Priority
- Low Priority
- Maintenance not needed at this time

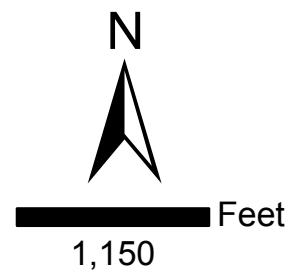

Horsley Witten Group
 Sustainable Environmental Solutions
 90 Route 6A • Sandwich, MA • 02563
 Tel: 508-833-8600 • Fax: 508-833-3150 • www.horsleywitten.com

Solitude Watershed - Culverts
 St. Croix
 East End Watersheds

Date: 9/19/2011 - mw

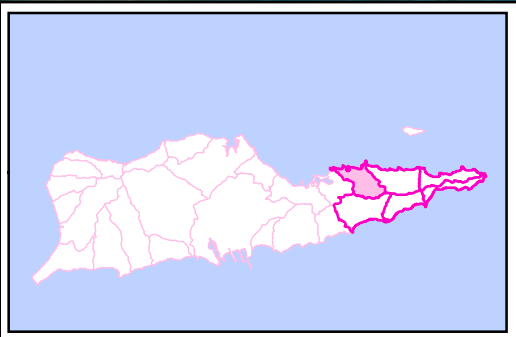

Legend

- Impaired 2010 303(d) List
- Southgate Watershed
- Watershed Boundaries
- Parcels
- Estate Boundaries with Names

- Guts
- 20ft. Contours
- Parks/Recreation/Open Space Lands
- Roadway Type**
- Dirt
- Paved

Retrofit Projects

- High Priority
- Medium Priority
- Low Priority

Pollution Prevention Projects

- High Priority

Gut Restoration Projects

- High Priority
- Medium Priority
- Low Priority

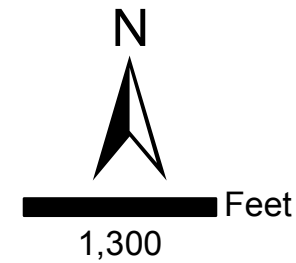

Horsley Witten Group
Sustainable Environmental Solutions
90 Route 6A • Sandwich, MA • 02563
Tel: 508-833-6600 • Fax: 508-833-3150 • www.horsleywitten.com

Southgate Watershed -
Project Ranking
St. Croix
East End Watersheds

Date: 9/19/2011 - mw

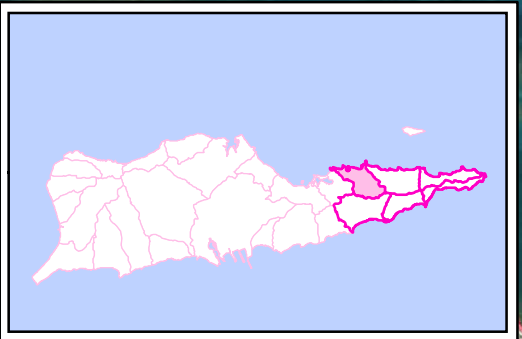
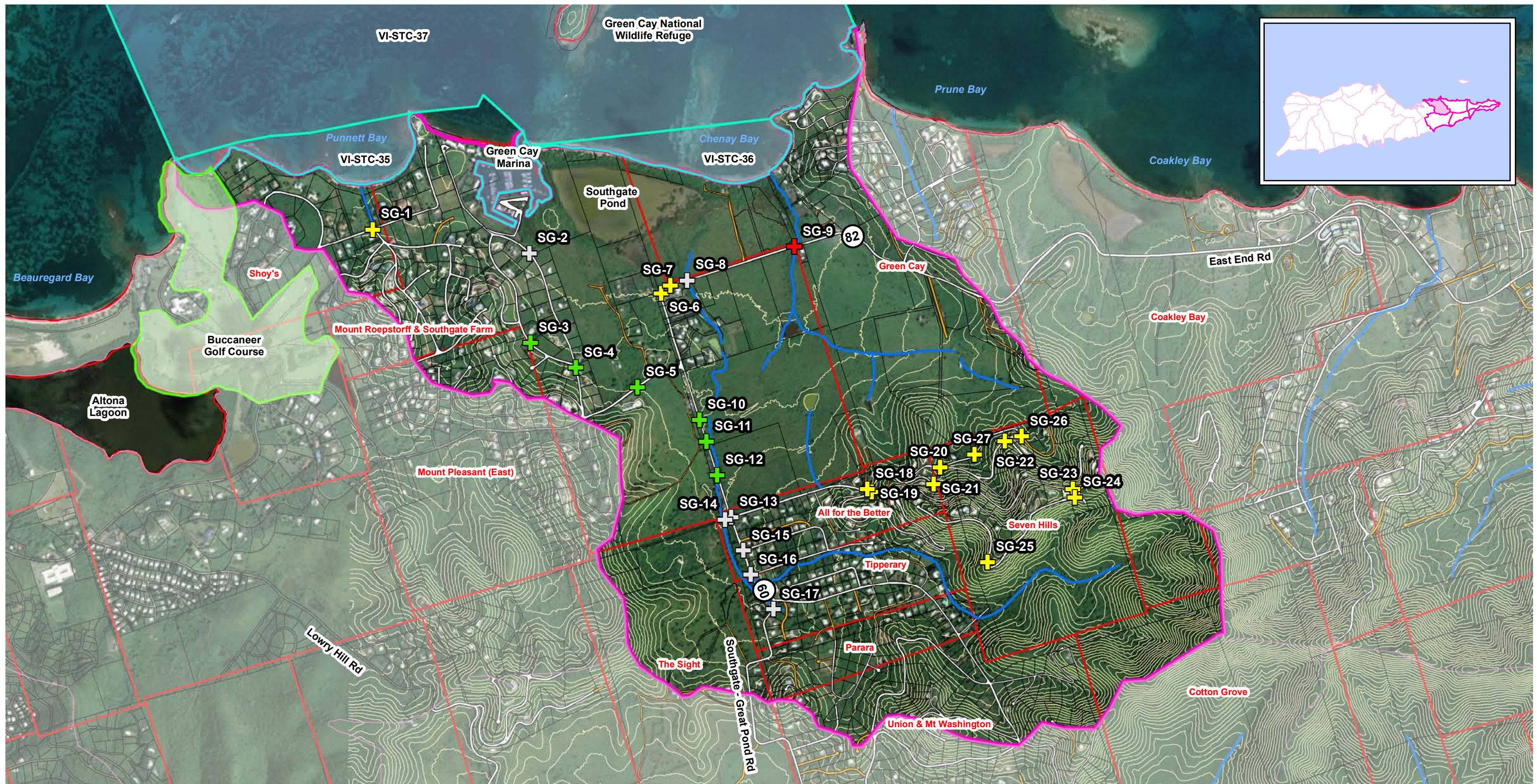

- Legend**
- Impaired 2010 303(d) List
 - Southgate Watershed
 - Watershed Boundaries
 - Parcels
 - Estate Boundaries with Names

- Guts
 - 20ft. Contours
 - Parks/Recreation/Open Space Lands
- Roadway Type**
- Dirt
 - Paved

- Culvert Maintenance**
- High Priority
 - Medium Priority
 - Low Priority
 - Maintenance not needed at this time

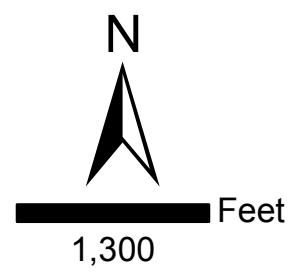

Horsley Witten Group
 Sustainable Environmental Solutions
 90 Route 6A • Sandwich, MA • 02563
 Tel: 508-833-6600 • Fax: 508-833-3150 • www.horsleywitten.com

Southgate Watershed - Culverts
 St. Croix
 East End Watersheds

Date: 9/19/2011 - mw

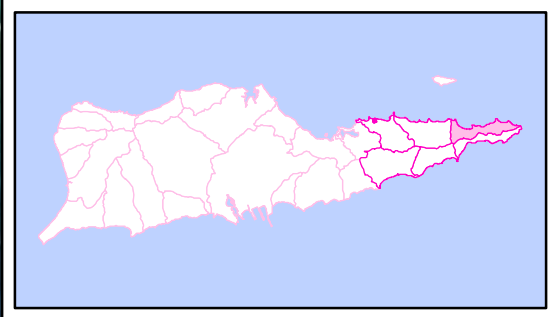

Legend

- Sediment Study Sites
- Teague Bay Watershed
- Watershed Boundaries
- Parcels
- Estate Boundaries with Names

- Roadway Type**
- Guts
 - 20ft. Contours
 - Parks/Recreation/Open Space Lands
 - Impaired 2010 303(d) List
 - TNC Preserve
- Roadway Type**
- Dirt
 - Paved

- Retrofit Projects**
- High Priority
 - Medium Priority
 - Low Priority
- Trail Stabilization Projects**
- High Priority

- Gut Restoration Projects**
- High Priority
 - Medium Priority
 - Low Priority

- Road Stabilization Projects**
- High Priority
 - Medium Priority
 - Low Priority



1,150 Feet

Horsley Witten Group
Sustainable Environmental Solutions
90 Route 6A • Sandwich, MA • 02503
Tel: 508-833-6600 • Fax: 508-833-3150 • www.horsleywitten.com

Teague Bay Watershed -
Project Ranking
St. Croix
East End Watersheds

Date: 9/19/2011 - mw



Legend

- Sediment Study Sites
- Teague Bay Watershed
- Watershed Boundaries
- Parcels
- Estate Boundaries with Names
- Guts
- 20ft. Contours
- Parks/Recreation/Open Space Lands
- Impaired 2010 303(d) List
- TNC Preserve

Roadway Type

- Dirt
- Paved

Culvert Maintenance

- High Priority
- Medium Priority
- Low Priority
- Maintenance not needed at this time

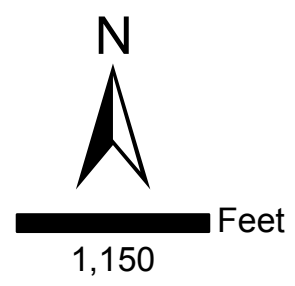

Horsley Witten Group
 Sustainable Environmental Solutions
 90 Route 6A • Sandwich, MA • 02503
 Tel: 508-833-6600 • Fax: 508-833-3150 • www.horsleywitten.com

Teague Bay Watershed - Culverts
 St. Croix
 East End Watersheds

Date: 9/19/2011 - mw

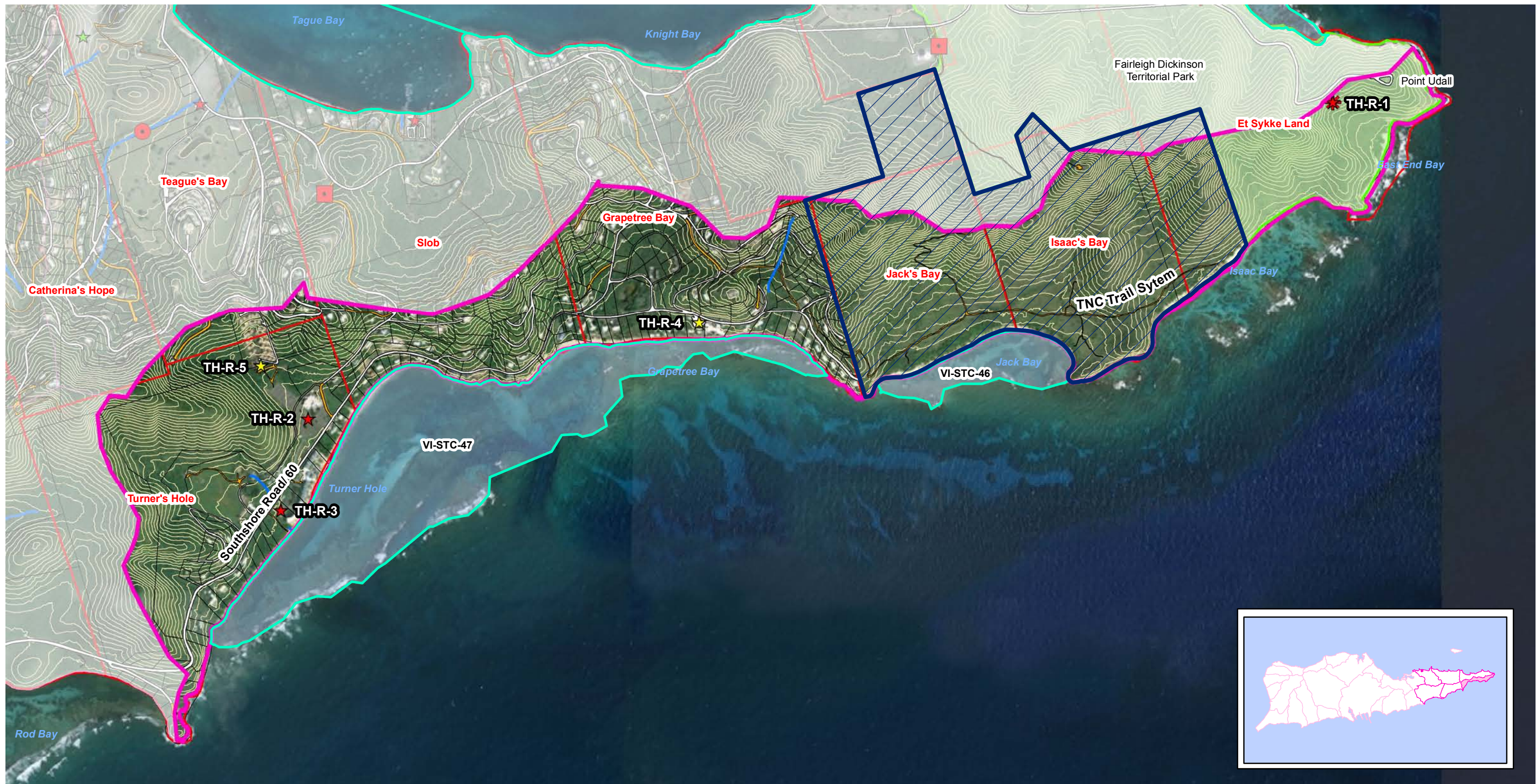

Legend

- Impaired 2010 303(d) List
- Turner Hole Watershed
- Watershed Boundaries
- Parcels
- Estate Boundaries with Names

- Guts
- 20ft. Contours
- Parks/Recreation/Open Space Lands
- TNC Preserve
- Roadway Type**
- Dirt
- Paved

Retrofit Projects

- High Priority
- Medium Priority
- Low Priority

Trail Stabilization Projects

- High Priority

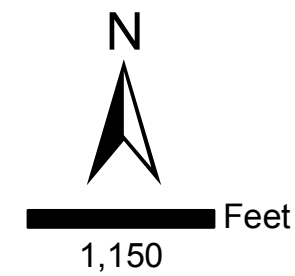

Horsley Witten Group
 Sustainable Environmental Solutions
 90 Route 6A • Sandwich, MA • 02563
 Tel: 508-833-5600 • Fax: 508-833-3150 • www.horsleywitten.com

Turner Hole Watershed -
 Project Ranking
 St. Croix
 East End Watersheds

Date: 9/19/2011 - mw

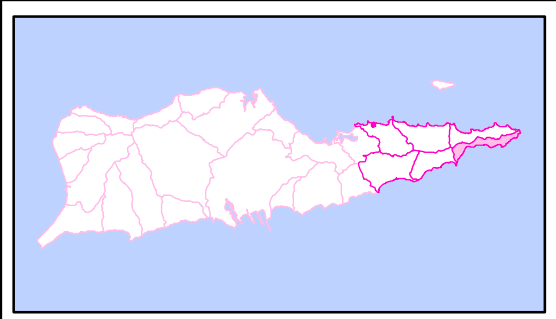
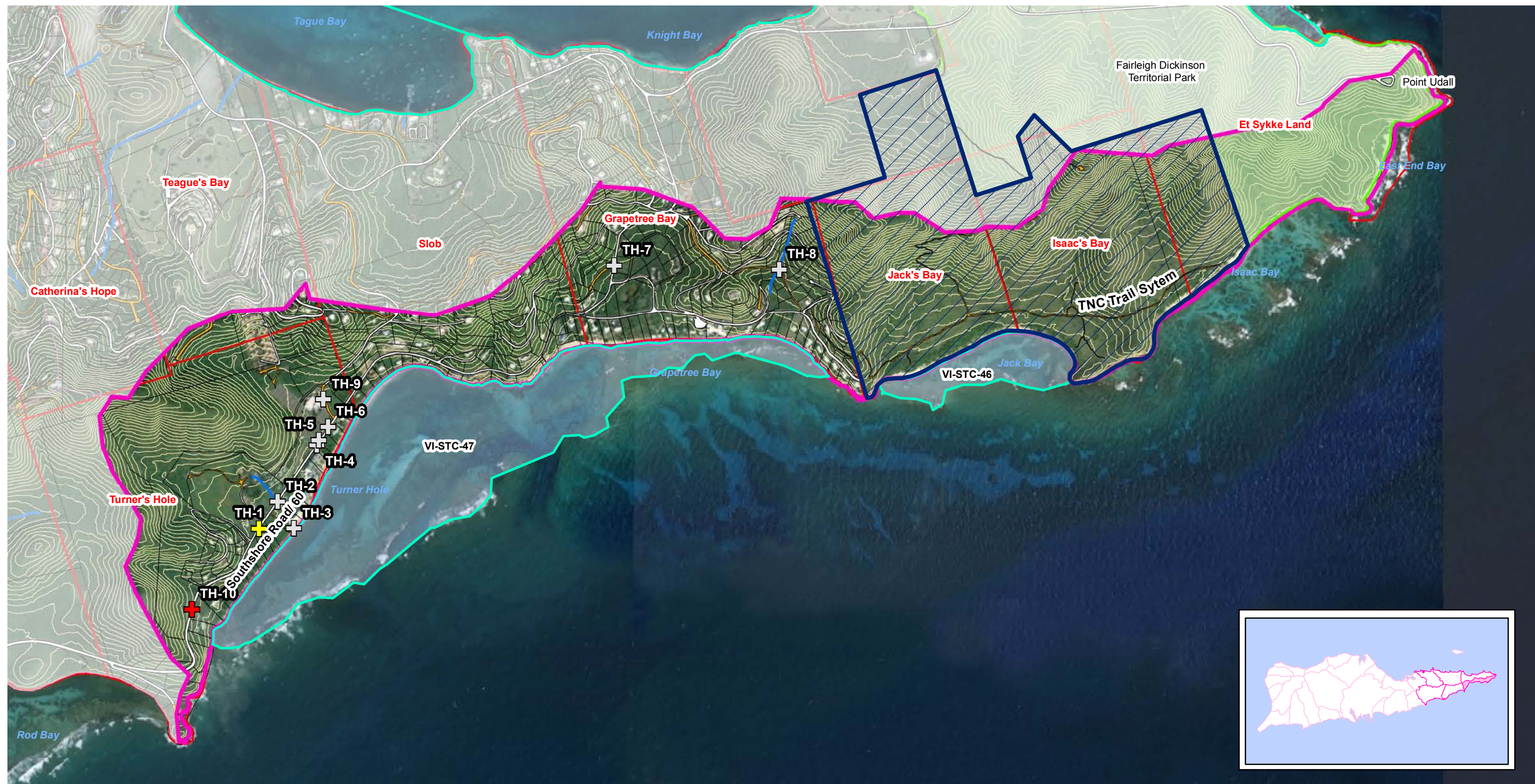

Legend

- Impaired 2010 303(d) List
- Turner Hole Watershed
- Watershed Boundaries
- Parcels
- Estate Boundaries with Names

- Guts
 - 20ft. Contours
 - Parks/Recreation/Open Space Lands
 - TNC Preserve
- Roadway Type**
- Dirt
 - Paved

Culvert Maintenance

- High Priority
- Medium Priority
- Low Priority
- Maintenance not needed at this time

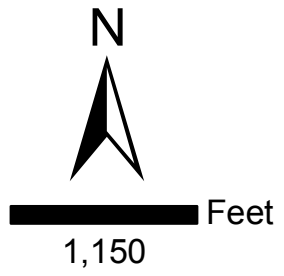

Horsley Witten Group
 Sustainable Environmental Solutions
 90 Route 6A • Sandwich, MA • 02563
 Tel: 508-833-5600 • Fax: 508-833-3150 • www.horsleywitten.com

Turner Hole Watershed -
 Culverts
 St. Croix
 East End Watersheds

Date: 9/19/2011 - mw

Appendix C

High Priority Concept Summaries

Adams' Farm East Gut (SG-G-2)
Divi Casino (TH-R-2A)
Divi Hotel/Resort (TH-R-3A)
Chenay Bay (SG-R-20A)
East End Bay Trail (TH-R-1)
Fire Station (SB-R-1B/A)
Goat Hill Rd. (TB-RC-4)
Milgie's Grocery Store (GP-RC-2)
Reef Golf Course (TB-R-3B/A; TB-G-1)
Ridge Rd. at Rt. 82(TB-RC-3)
Seven Flags Rd. (SB-R-3/SB-RC-9)
St. Croix Yacht Club (TB-R-2B)
Unnamed Rd. (GP-RC-33)

Adams' Farm (East Gut) Southgate

Project ID: SG-G-2

Type: Gut stabilization

Description: This concept is focused on the prevention of further migration of a 10'-12' deep, three-lobed headcut that is actively eroding southward across Adam's Farm cattle and horse pastureland towards an existing impoundment. The estimated drainage area to the gut is 130 acres. The estimated rate of headcut migration is approximately 10 ft/year based on a mapping analysis between comparing the location of the headcut perimeter between 2007 and 2011. This is consistent with anecdotal reports from the property owner estimating 10-15 ft/yr and is equivalent to erosion of almost 500 cubic yards of material. This concept involves the formalization and re-vegetation of the overland flow path between the pond and the gut, as well as the excavation, re-grading, and stabilization of the top of the gut.

Constraints: None. Access is good. It should be noted that stabilization with concrete and riprap is not necessarily the preferred approach to gut restoration; however, in this instance, a combination of "hard" and "soft" solutions is proposed.

Key Design Elements:

1. Installation of a culvert under dirt driveway that is designed to pass the 1-yr rainfall event;
2. Proposed 330 ft channel stabilized with turf reinforcement mat to convey overland flows to the existing gut;
3. Installation of a cattle crossing pad across for restricted, stabilized access across grass channel;
4. Use of a boulder drop structure to convey flows down into gut without additional erosion;

5. Grouted boulder low flow channel with 4:1 side slopes stabilized with coir fabric and local plantings; and
6. Two additional boulder drop structures (length ~100 ft) two convey flow from side lobes into grouted boulder low flow channel.

See more detailed design plan set at: www.horsleywitten.com/stx-east-end-watersheds/designs.html



Existing impoundment above headcut.



Existing overland flow path, and site of proposed reinforced channel.



The uppermost of three-lobed headcut.

Site Map:

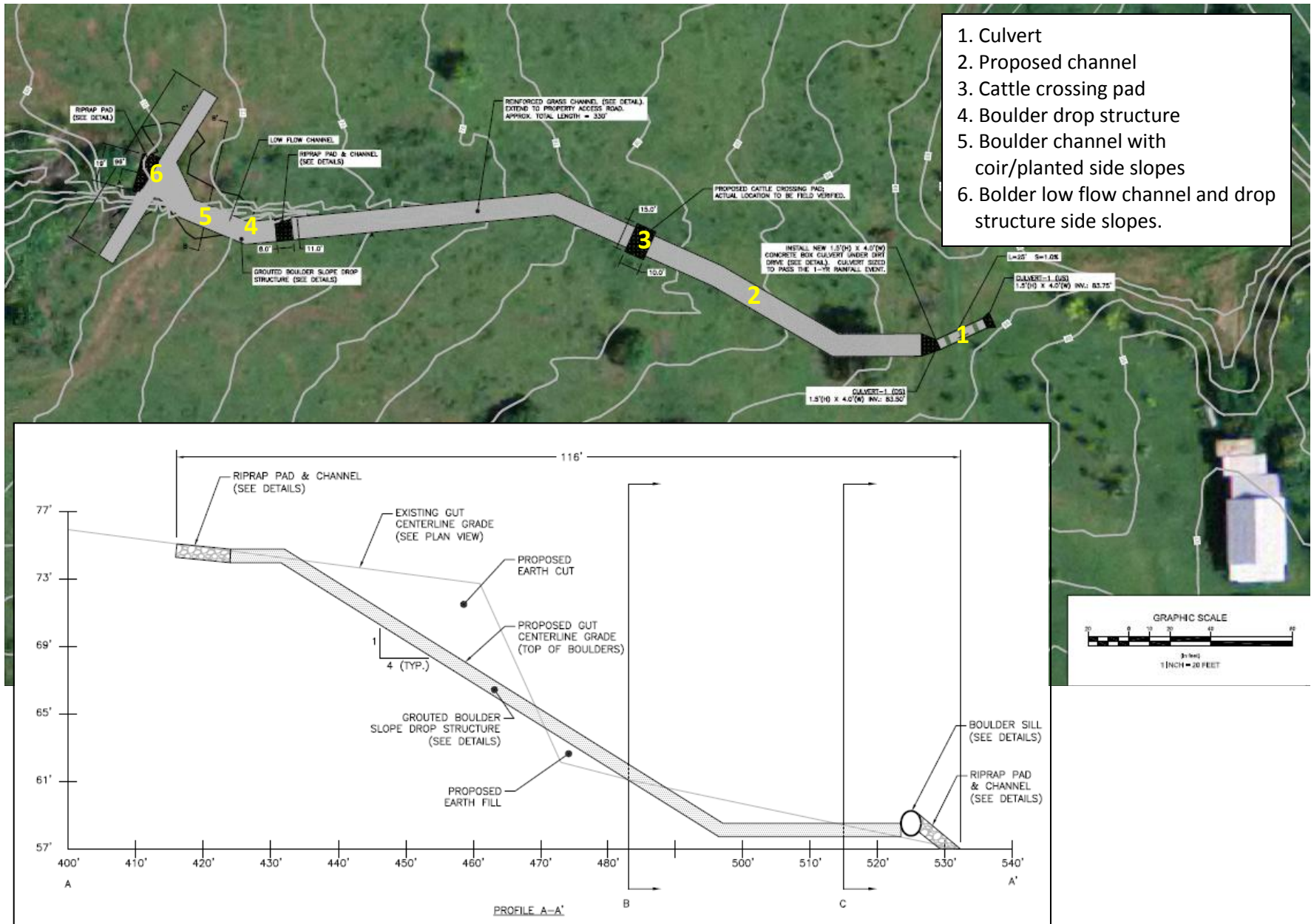

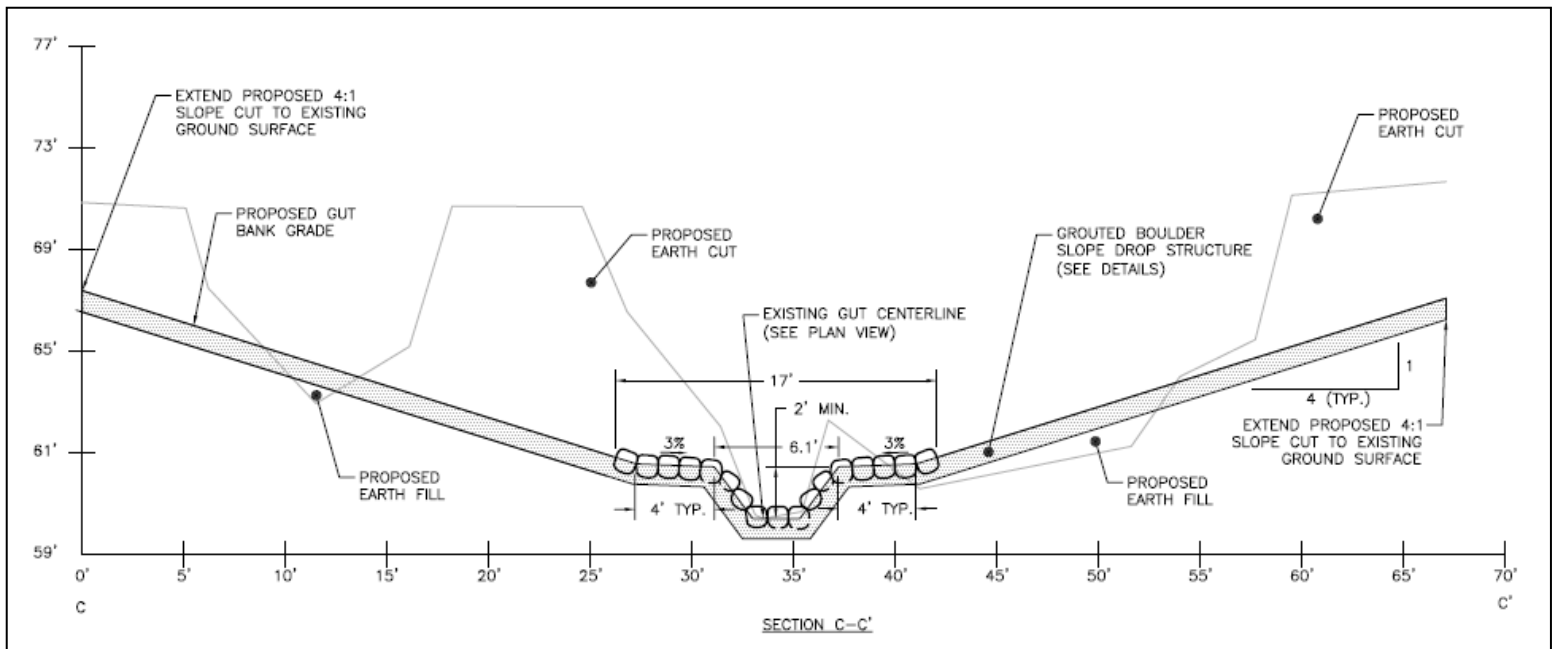
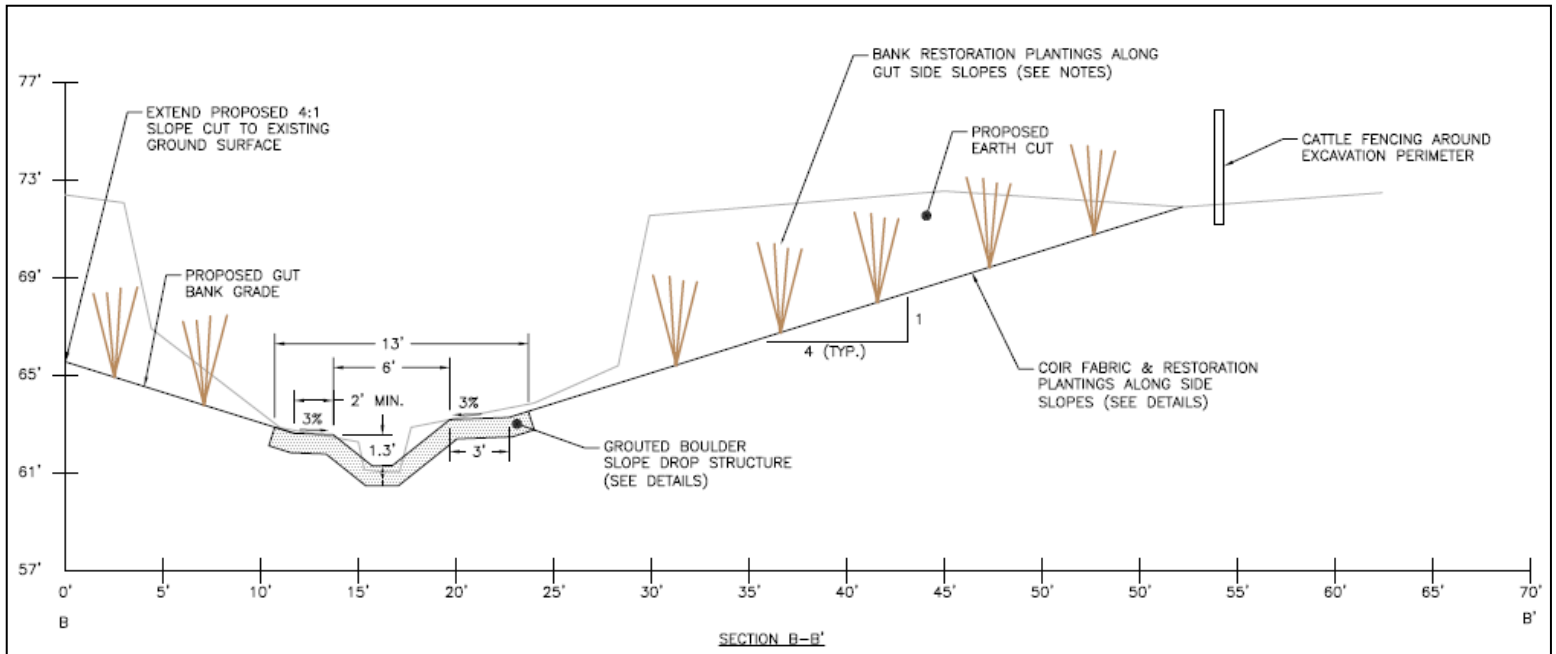

Planning Level Cost Estimate:

**ADAMS' GUT RESTORATION
ESTIMATE OF CONSTRUCTION QUANTITIES & COSTS
ST. CROIX, USVI**

SEPT. 2011

Quantities listed are estimates only and not guaranteed to approximate the actual amounts to be used.

ITEM NUMBER	DESCRIPTION	ESTIMATED QUANTITY	UNIT	UNIT PRICE	STX UNIT PRICE	TOTAL AMOUNT
1.01	MOBILIZATION/DEMobilIZATION	1	LUMP SUM	-	\$10,000.00	\$10,000
1.02	SITE CLEARING & GRUBBING	580	SQUARE YARD	\$2.50	\$3.25	\$1,900
1.03	EXCAVATION	500	CUBIC YARD	-	\$27.00	\$13,500
1.04	FINE GRADING AND COMPACTION	1,200	SQUARE YARD	\$2.00	\$2.60	\$3,200
1.05	CLEAN SAND	80	CUBIC YARD	\$80.00	\$104.00	\$8,400
1.06	LOAM & SEED	440	SQUARE YARD	\$5.00	\$6.50	\$2,900
1.07	CRUSHED STONE	4	CUBIC YARD	\$42.00	\$54.60	\$300
1.08	RIPRAP	16	CUBIC YARD	\$50.00	\$65.00	\$1,100
1.09	BOULDERS FOR DROP STRUCTURE	200	CUBIC YARD	\$200.00	\$260.00	\$52,000
1.10	CONTROLLED DENSITY FILL	60	CUBIC YARD	-	\$200.00	\$12,000
1.11	1.5' X 4' CONCRETE BOX CULVERT	25	LINEAR FOOT	-	\$400.00	\$10,000
1.12	CONCRETE HEADWALLS & WINGWALLS	2	EACH	\$3,000.00	\$3,900.00	\$7,300
1.13	TURF REINFORCEMENT MAT	550	SQUARE YARD	\$8.00	\$10.40	\$5,800
1.14	FILTER FABRIC	60	SQUARE YARD	\$3.00	\$3.90	\$300
1.15	COIR FABRIC	250	SQUARE YARD	\$8.00	\$10.40	\$2,600
1.16	SILT FENCE FOR EROSION CONTROL	50	LINEAR FOOT	-	\$9.00	\$500
1.17	RESTORATION PLANTINGS	1	LUMP SUM	-	\$20,000.00	\$20,000

SUB TOTAL \$151,800

ESTIMATED BID PRICE **\$ 152,000**

Contingency 30% \$ 46,000

ESTIMATED CONSTRUCTION CONTRACT **\$ 198,000**

Project ID: TH-R-2A, TH-R-2A, TH-R-2C

Type: Retrofit, road stabilization

Description: Retrofit of existing detention basin to provide better water quality treatment and demonstrate preferred design feature of this type of BMP. Total drainage area to the existing practice is approximately 66 acres, with more than 13 acres of impervious cover consisting of parking lot, roads, and roof top.

Key Design Elements:

1. Installation of paved flumes to direct runoff from upper parking lot into existing grass swale;
2. Excavate existing grass swale along Ridge Rd. to remove sediment that has been deposited overtime; insert check dam below culvert to create sediment forebay to help trap sediment and slow velocities;
3. Install water bars on Ridge Rd. to stabilize road surface and direct runoff into existing swale;
4. Create sediment forebay where flows enter detention basin using check dam and concrete box structure that can be maintained;
5. Extend flow path within detention basin by the use of a gabion basket berm;
6. Raise existing berm and modify outlet structure to detain flows and provide opportunity for permant pool;
7. Plant wetland species;
8. Install simple rain gardens in existing landscape islands to provide additional pretreatment;

See more detailed design plan set at:
www.horsleywitten.com/stx-east-end-watersheds/designs.html



Existing swale along Ridge Rd. for proposed excavation and check dam installation. Install waterbars along road.



Existing detention basin with double outlet pipes along South Shore Rd.



Parking lot landscape island for proposed conversion to rain garden, which would provide additional pretreatment for detention basin.

Site Map:

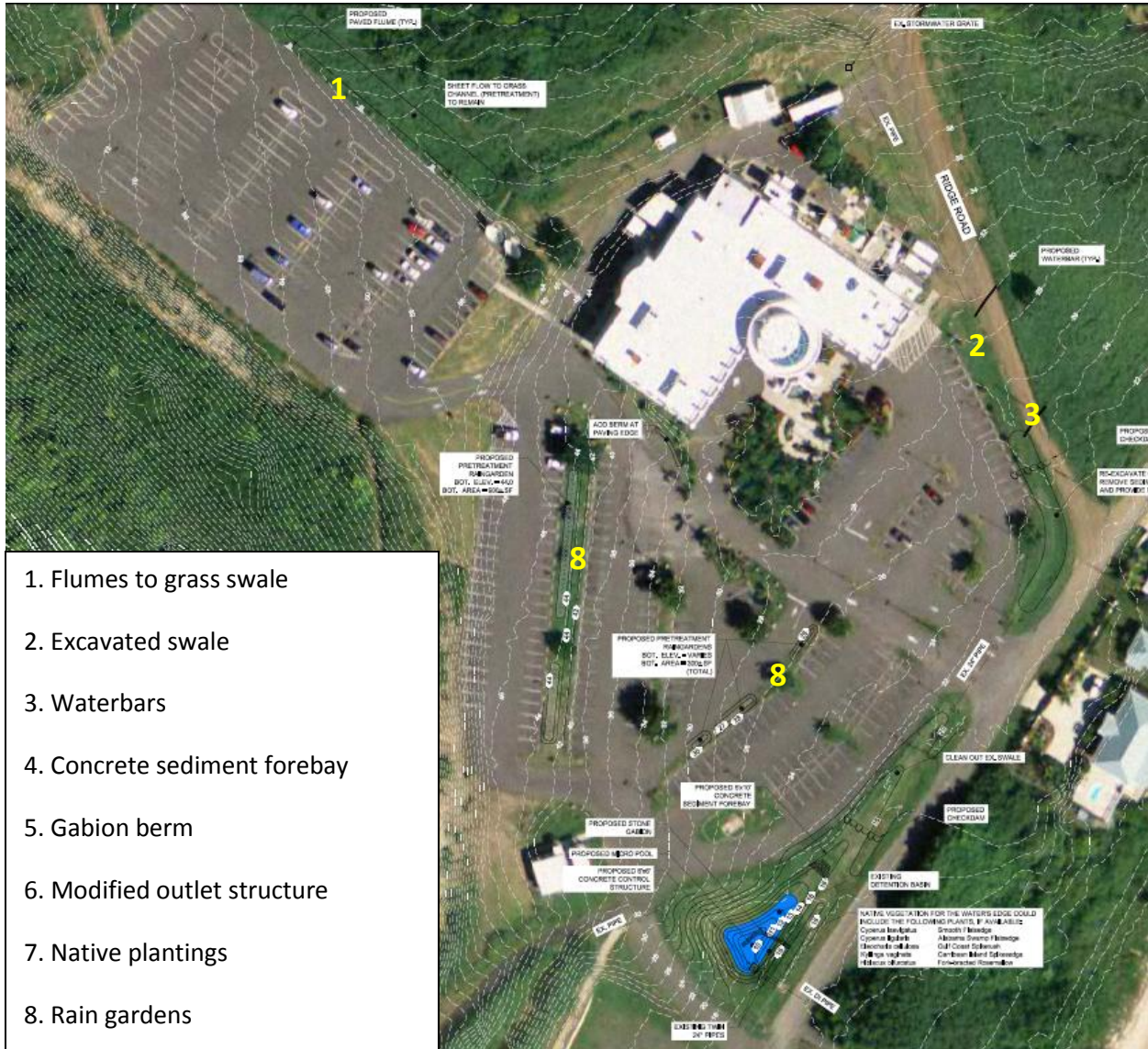

1. Flumes to grass swale
2. Excavated swale
3. Waterbars
4. Concrete sediment forebay
5. Gabion berm
6. Modified outlet structure
7. Native plantings
8. Rain gardens

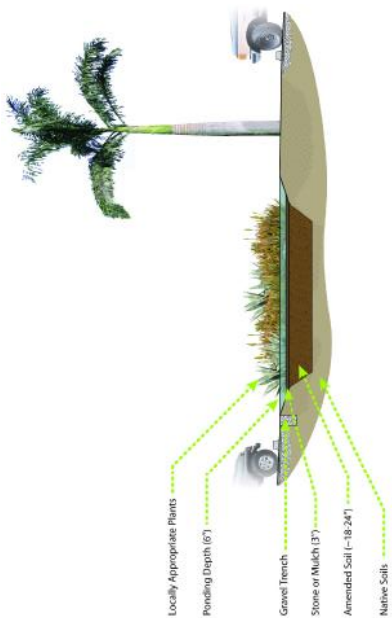

Planning Level Cost Estimate:

**DIVI CASINO
ESTIMATE OF CONSTRUCTION QUANTITIES & COSTS
ST. CROIX, USVI**

SEPT. 2011

Quantities listed are estimates only and not guaranteed to approximate the actual amounts to be used.

ITEM NUMBER	DESCRIPTION	ESTIMATED QUANTITY	UNIT	MA UNIT PRICE	UNIT PRICE	TOTAL AMOUNT
1.0	MOBILIZATION/DEMOBILIZATION	1	LUMP SUM		\$6,000.00	\$6,000
2.0	SITE CLEARING & GRUBBING	1,503	SQUARE YARD	\$2.50	\$3.25	\$4,883
3.0	EXCAVATION	272	CUBIC YARD	\$30.00	\$39.00	\$10,597
4.0	FINE GRADING AND COMPACTION	700	SQUARE YARD	\$2.00	\$2.60	\$1,820
5.0	LOAM & SEED	830	SQUARE YARD	\$5.00	\$6.50	\$5,397
6.0	RIPRAP	10	CUBIC YARD	\$100.00	\$130.00	\$1,300
7.0	GABION BASKET	16	CUBIC YARD		\$400.00	\$6,222
8.0	TIMBERS FOR SEDIMENT FOREBAY & CHECK DAMS	75	LINEAR FOOT	\$10.00	\$13.00	\$975
9.0	WATER BAR	2	EACH		\$2,000.00	\$4,000
10.0	BITUMINOUS BERM	40	LINEAR FOOT	\$10.00	\$13.00	\$520
11.0	CURB STOPS	25	EACH	\$60.00	\$78.00	\$1,950
12.0	SEDIMENT FOREBAY	1	EACH	\$4,000.00	\$5,200.00	\$5,200
13.0	6'X6' CONCRETE CONTROL STRUCTURE	1	EACH	\$4,000.00	\$5,200.00	\$5,200
14.0	RAIN GARDEN-PLANTS/SOIL/MULCH	1,200	SQUARE FOOT	\$10.00	\$13.00	\$15,600
15.0	PLANTS FOR DETENTION BASIN	2,472	SQUARE FOOT	\$6.00	\$7.80	\$19,282

SUB TOTAL \$89,000

\$ -

ESTIMATED BID PRICE

\$ 89,000

Contingency

30%

\$ 27,000

ESTIMATED CONSTRUCTION CONTRACT

\$ 116,000

This page intentionally left blank.

Project ID: TH-R-3A/B/C/D

Type: Retrofit

Description: Retrofit concept includes the expansion and modification of the existing detention basin to improve water quality treatment. The existing facility appears undersized for the amount of area draining to it. Other options for this site include installation of rain gardens in the parking lots and potential permeable pavement installation in small northern parking area.

Key Design Elements:

1. Modify existing detention basin:
 - Over-excavate to expand and to amend basin with organic soils;
 - Install culvert under existing walkway;
 - Create sediment forebay at existing inlet pipes with timber or concrete weir;
 - Plant with umbrella sedge or other hydrophilic species; and
 - Install new outlet pipe.
2. Permeable pavement in the small north parking lot;
3. Rain garden in existing landscaped area on edge of north lot (see existing curb cut); and
4. Rain garden/swale across South Shore Rd. along edge of gravel parking lot.



Existing detention basin proposed for modification.



Location for proposed rain garden or bioswale.



Small parking lot and landscaped area proposed for permeable pavement and rain garden.

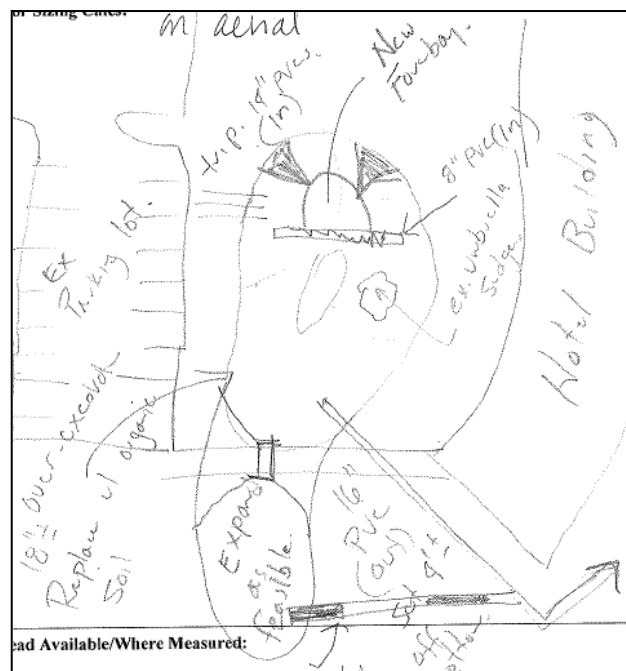

Sketch of expanded detention basin and forebay.

Site Map:

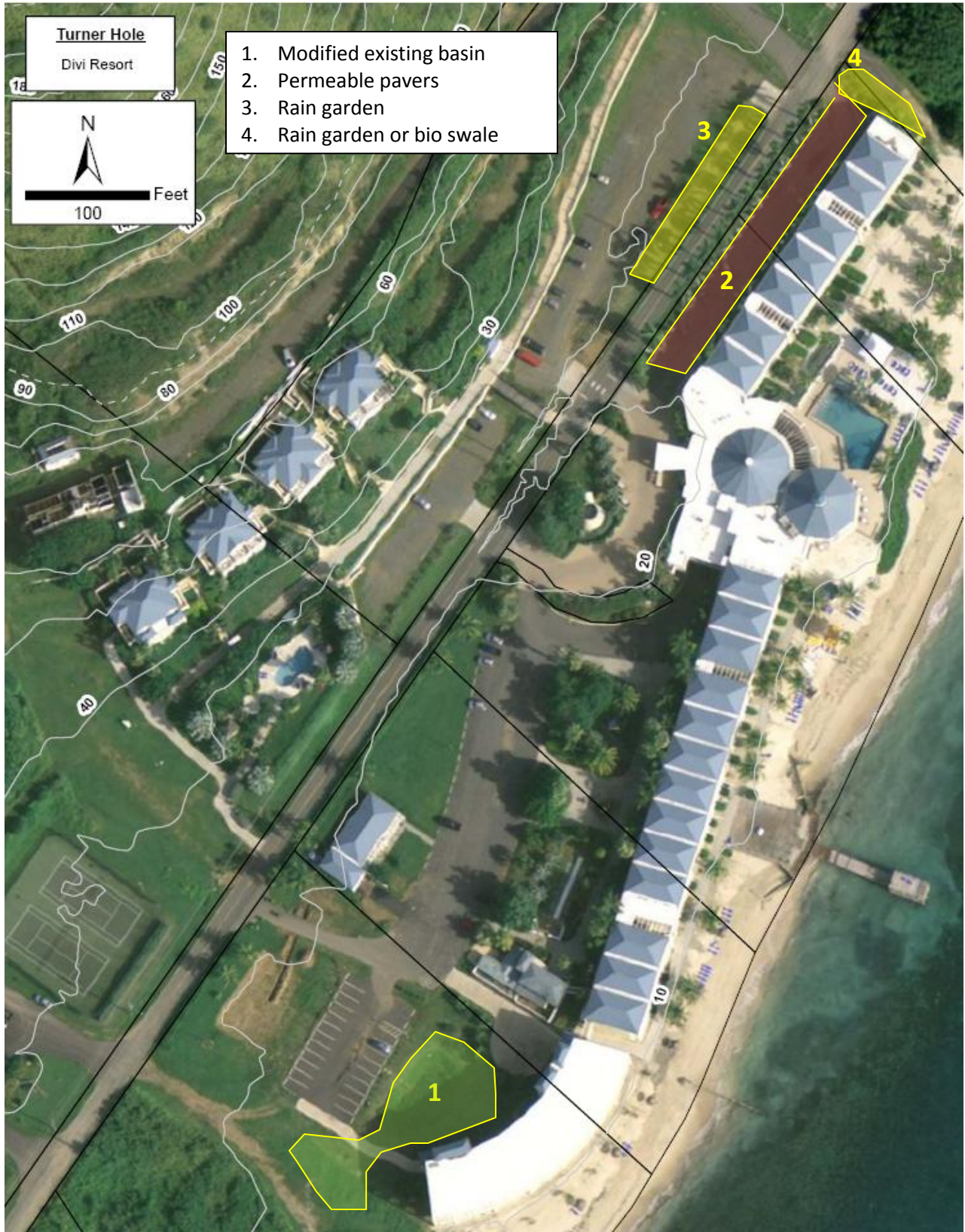

Chenay Bay Southgate

Project ID: SG-R-20A/B

Type: Retrofit, pollution prevention

Description: Retrofit concept includes the installation of a rain garden adjacent to the restaurant at Chenay Bay Resort, as well as the installation of a shallow bioretention in the parking lot to provide some water quality treatment prior to discharge into the adjacent wetland. Both features could serve not only to improve stormwater management, but can also improve site aesthetics. Pollution prevention activities at this site include the cleanup of trash in the wetland area, covering of outdoor material storage area, and restoration of riparian buffer adjacent to East Gut outlet.

Key Design Elements:

1. Extend paved flume around corner of restaurant and install gutter/downspout on new desk addition to convey flows into a small sediment forebay;
2. Excavate a ~900 sq ft (max to treat 1.25 inches) rain garden in turf area adjacent to restaurant. This highly visible location with good access can be used as a demonstration site, involve volunteers for construction, and the donation of plant materials;
3. Overflow from the rain garden can go towards the beach;
4. Remove pavement along wetland edge and install bioswale; repave and/or restripe parking lot;
5. Discharge overflow pipe into wetland area;
6. Install a cover on the existing concrete structure where outdoor materials are stored;
7. Coordinate with SEA to establish trash cleanup days for wetland and beach area.



Proposed area for rain garden installation. Extend existing paved flume and install gutter and downspouts to convey flows to sediment forebay.



Location along edge of parking lot to install water quality facility to treat parking lot runoff.



Existing outdoor material storage area that could use a cover.

Site Map:

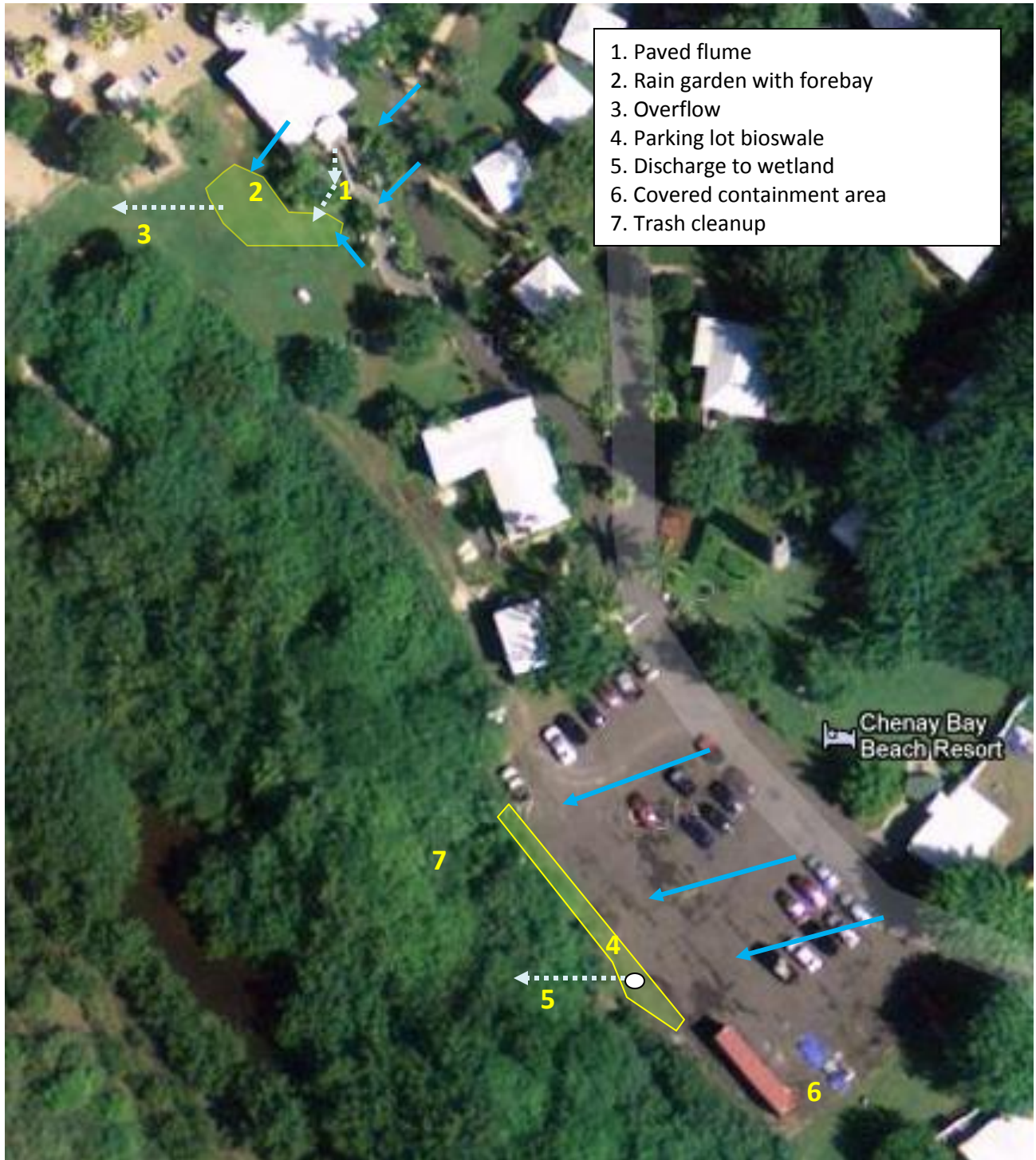

East End Bay Trail Turner Hole

Project ID: TH-R-1

Type: Retrofit

Description: Concept includes installing a bioretention facility adjacent to the recently stabilized trailhead at the East End/Point Udall to capture and treat runoff from the newly installed parking lot and East End Rd. Landscape plantings were specifically selected to reflect the dry conditions and native species located at the East End.

Constraints: Potential depth to bedrock/rotten rock. This plan was reviewed by site contractor and a bid estimate was generated based on the quantity take-off provided below. The bid estimate came back extremely high, with little justification provided per unit cost assumptions. There is little evidence that this concept, as proposed, will move forward; however, the plan details provide a model example of a dry climate bioretention application.

Key Design Elements:

1. Removal of debris pile and shallow excavation of area for proposed bioretention;
2. Use of existing rock on site to build revetment on hillside of proposed bioretention;
3. Install asphalt v-ditch to convey flows from edge of parking lot into rip rap channel;
4. 12-foot long rip-rap channel to convey flows into bioretention facility;
5. 560 sq ft bioretention facility planted with cactus and other drought/salt tolerant species; and
6. Overflow spillway back towards trail, uphill from first existing water bar/trail drainage stabilization feature.

See more detailed design plan set at: www.horsleywitten.com/stx-east-end-watersheds/designs.html. Note that plan set includes detailed Erosion and Sediment Control practices and detailed planting plan.



Trailhead location map.



Newly installed parking lot and trailhead.



Signage posted at site indicating funding and project oversight for the trail stabilization project.

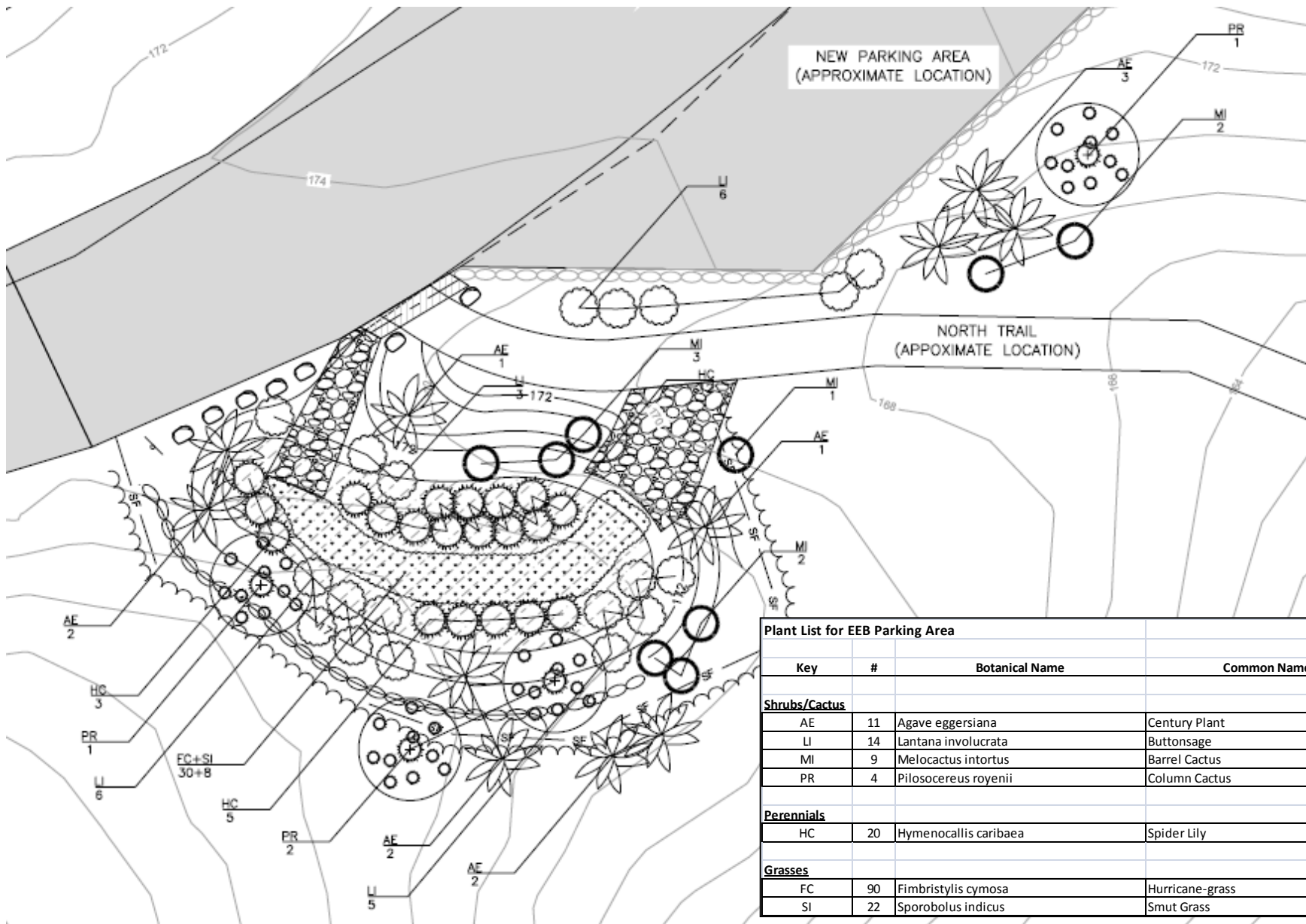

Planning Level Quantity Estimates:

**EAST END BAY TRAIL BIORETENTION AREA
ST. CROIX, USVI**

3/3/2011

Quantities listed are estimates only and not guaranteed to approximate the actual amounts to be used.

ITEM NUMBER	DESCRIPTION	ESTIMATED QUANTITY	UNIT
1.0	MOBILIZATION/DEMobilIZATION	1	LUMP SUM
2.0	SITE CLEARING & GRUBBING	170	SQUARE YARD
3.0	BIORETENTION	560	SQUARE FOOT
4.0	FILTER FABRIC	409	SQUARE FOOT
5.0	STONE RETAINING WALL/BOULDERS	25	CUBIC YARD
6.0	CLEAN SAND	2	CUBIC YARD
7.0	RIP RAP	6	CUBIC YARD
8.0	CRUSHED STONE	1	CUBIC YARD
9.0	ASPHALT	1	SQUARE YARD
10.0	EROSION CONTROL BLANKET	128	SQUARE YARD
11.0	SILT FENCE FOR EROSION CONTROL	77	LINEAR FOOT

Bioretention Broken Down			
ITEM	DESCRIPTION	UNIT	QUANTITY
	Bio Excavation	CY	135
	18" Planting Soil	CY	32
	3" Pea Gravel	CY	6
	9" Stone	CY	16
	Bioretention plantings	LS	1

Fire Station

Solitude Bay

Project ID: SB-R-1A/B

Type: Retrofit, pollution prevention

Description: Retrofit concept includes the installation of a rain garden and dry swale to capture and treat road and driveway drainage. It is assumed that the parking area for the proposed Police Substation will drain to the dry swale. A second part of the project entails the relocation of the Cotton Valley Dumpster Site to the Solitude Fire Station property, which would include upgrades to improve pollution prevention measures.

Site Constraints: There is an existing well at the site, which may limit the potential to install a rain garden.

Key Design Elements:

1. Install ~2,900 square foot rain garden at the corner of property; install paved flume and sediment forebay to better direct flows from road and trap sediment behind timber weir structure;
2. Rain garden overflow and additional road drainage conveyed via paved swale across bus stop and fire station entrance and proposed driveway to relocated dumpster area;
3. Drainage from the paved swales and from the proposed dumpster driveway are directed to the pretreatment forebay of a dry swale;
4. The dry swale outlet structure includes a trash rack, and discharges to the existing gut;
5. Construct covered enclosure for dumpster area, with concrete sidewalls and fencing in rear to reduce wind-blown trash accumulation in gut;

6. Install cistern to collect and reuse rooftop runoff from dumpster area; and
7. Remove invasive species and enhance native plantings along gut buffer.

See more detailed design plan set at: www.horsleywitten.com/stx-east-end-watersheds/designs.html



Proposed area for rain garden.



Existing swale to be converted to water quality dry swale.



Existing covered enclosure from St. Thomas similar to proposed dumpster enclosure design for Fire Station.

Site Map:

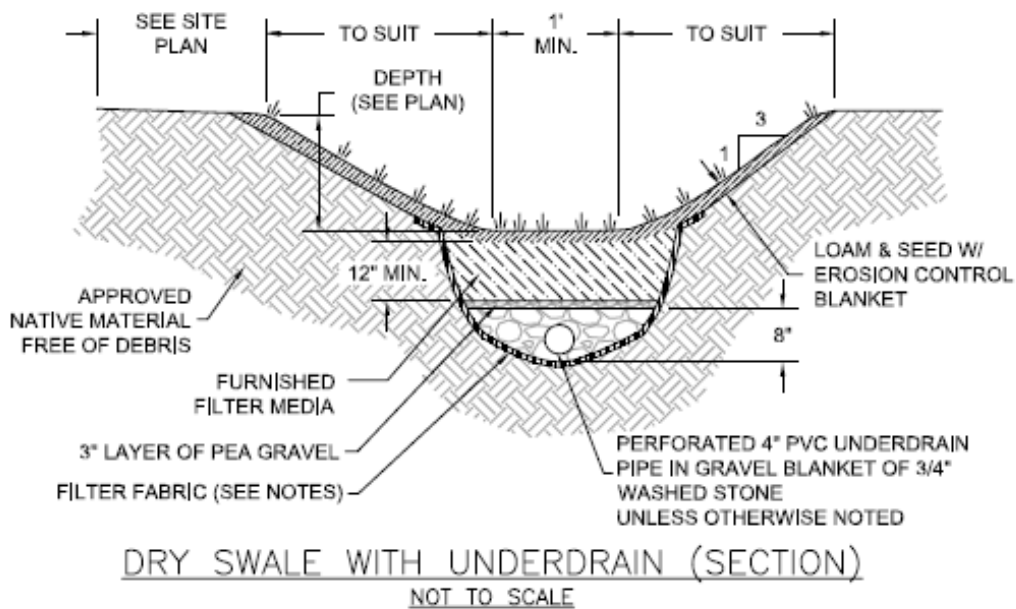
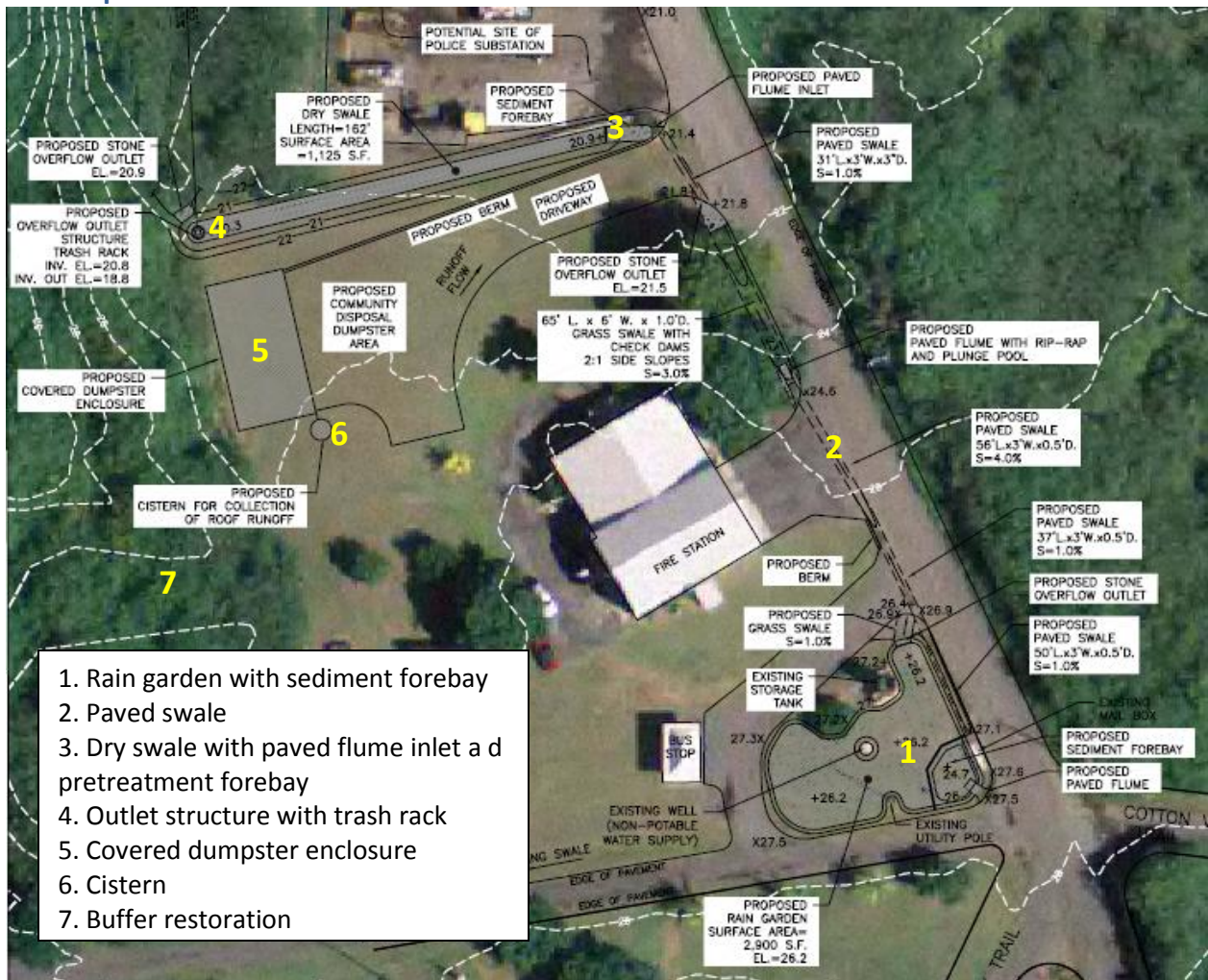

Planning Level Cost Estimate:

**SOLITUDE FIRE STATION-DRAINAGE
ESTIMATE OF CONSTRUCTION QUANTITIES & COSTS
ST. CROIX, USVI**

SEPT. 2011

Quantities listed are estimates only and not guaranteed to approximate the actual amounts to be used.

ITEM NUMBER	DESCRIPTION	ESTIMATED QUANTITY	UNIT	MA-UNIT PRICE	UNIT PRICE	TOTAL AMOUNT
1.0	MOBILIZATION/DEMobilIZATION	1	LUMP SUM	\$11,000.00	\$14,300.00	\$14,300
2.0	SITE CLEARING & GRUBBING	1,001	SQUARE YARD	\$2.50	\$3.25	\$3,300
3.0	EXCAVATION	400	CUBIC YARD	\$30.00	\$39.00	\$15,600
4.0	FINE GRADING AND COMPACTION	600	SQUARE YARD	\$2.00	\$2.60	\$1,600
5.0	CLEAN SAND	20	CUBIC YARD	\$80.00	\$104.00	\$2,100
6.0	LOAM & SEED	444	SQUARE YARD	\$5.00	\$5.00	\$2,300
7.0	CRUSHED STONE	9	CUBIC YARD	\$72.00	\$93.60	\$900
8.0	RIPRAP	20	CUBIC YARD	\$100.00	\$130.00	\$2,600
9.0	TIMBERS FOR SEDIMENT FOREBAY & CHECK DAMS	115	LINEAR FOOT	\$10.00	\$13.00	\$1,500
10.0	ASPHALT	10	TONS		\$200.00	\$2,100
11.0	BITUMINOUS BERM	10	LINEAR FOOT	\$10.00	\$13.00	\$200
12.0	PAVED FLUME	3	EACH	\$1,500.00	\$1,950.00	\$5,900
13.0	OVERFLOW OUTLET STRUCTURE	1	EACH	\$4,000.00	\$5,200.00	\$5,200
14.0	12" HDPE PIPE	165	LINEAR FOOT		\$150.00	\$24,800
15.0	12" FLARED END SECTION	1	EACH	\$1,000.00	\$1,300.00	\$1,300
16.0	FILTER FABRIC	230	SQUARE YARD	\$3.00	\$3.90	\$900
17.0	COIR FABRIC	205	SQUARE YARD	\$8.00	\$10.40	\$2,200
18.0	SILT FENCE FOR EROSION CONTROL	200	LINEAR FOOT		\$9.00	\$1,800
19.0	DRY SWALE-TURF/SOIL/STONE	162	LINEAR FOOT	\$24.00	\$31.20	\$5,100
20.0	RAIN GARDEN-PLANTS/SOIL/MULCH	1	LUMP SUM	\$27,000.00	\$35,100.00	\$35,100

SUB TOTAL \$128,800

ESTIMATED BID PRICE		\$ -
Contingency	30%	\$ 129,000
ESTIMATED CONSTRUCTION CONTRACT		\$ 39,000
		\$ 168,000

**SOLITUDE FIRE STATION-COMMUNITY DUMPSTER AREA RELOCATION
ESTIMATE OF CONSTRUCTION QUANTITIES & COSTS
ST. CROIX, USVI**

SEPT. 2011

Quantities listed are estimates only and not guaranteed to approximate the actual amounts to be used.

ITEM NUMBER	DESCRIPTION	ESTIMATED QUANTITY	UNIT	MA-UNIT PRICE	UNIT PRICE	TOTAL AMOUNT
1.0	MOBILIZATION/DEMObILIZATION	1	LUMP SUM	\$12,950.00	\$16,835.00	\$16,900
2.0	SITE CLEARING & GRUBBING	1,035	SQUARE YARD	\$2.50	\$3.25	\$3,400
3.0	EXCAVATION	160	CUBIC YARD	\$30.00	\$39.00	\$6,300
4.0	FINE GRADING AND COMPACTION	718	SQUARE YARD	\$2.00	\$2.60	\$1,900
5.0	LOAM & SEED	60	SQUARE YARD	\$5.00	\$6.50	\$400
6.0	CRUSHED STONE	160	CUBIC YARD	\$72.00	\$93.60	\$15,000
7.0	COVERED DUMPSTER ENCLOSURE	1	LUMP SUM	\$60,000.00	\$78,000.00	\$78,000
8.0	ASPHALT	120	TONS		\$200.00	\$24,000
9.0	BITUMINOUS BERM	150	LINEAR FOOT	\$10.00	\$13.00	\$2,000
10.0	CISTERN	1	EACH	\$5,000.00	\$5,000.00	\$5,000
11.0	SILT FENCE FOR EROSION CONTROL	80	LINEAR FOOT		\$9.00	\$800

SUB TOTAL \$153,700

\$ -

ESTIMATED BID PRICE

\$ 154,000

Contingency 30%

\$ 47,000

ESTIMATED CONSTRUCTION CONTRACT

\$ 201,000

Goat Hill Rd. Teague Bay

Project ID: TB-RC-4

Type: Road stabilization

Description: Project concept is to stabilize approximately 1200 ft of unpaved road that is managed by The Nature Conservancy and the Department of Recreation.

Key Design Elements:

1. Install series of waterbars and stabilized outlets/bleed-offs in mid-upper portion of road as needed based on slope;
2. Restrict vehicle access;
3. Install bleed-offs and waterbars to maintain integrity of lower portion of road;
4. Install swale with check dams along inside right-of-way on East End Rd. to safely convey flows to existing paved cross-dip.



Lower portion of road that is relatively stable at this time.



Space alongside road to install stepped/check dam system.



Erosion along ditch at upper portion of road.

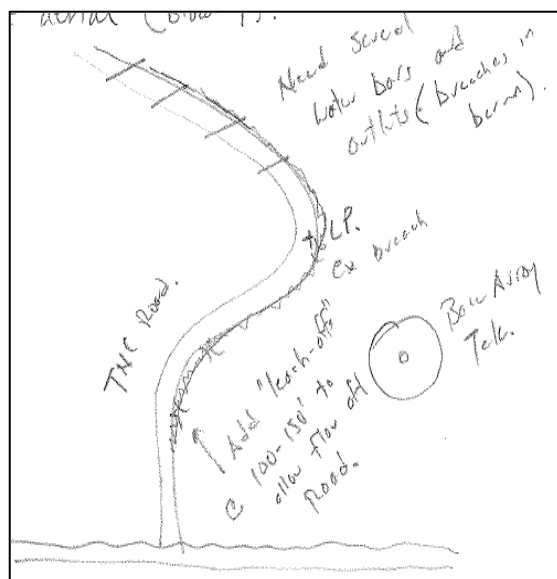

Sketch from field sheet.

Site Map

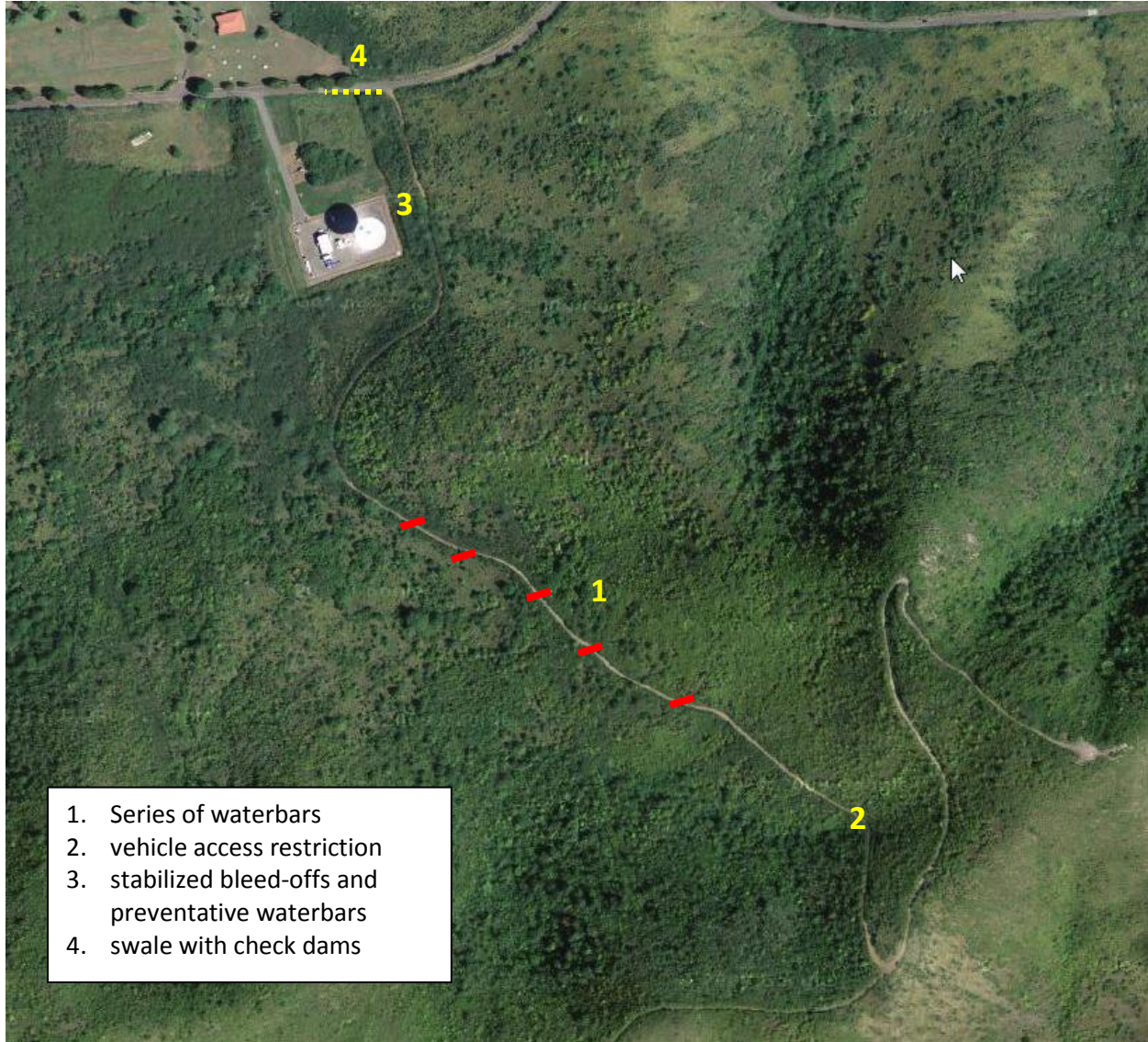

1. Series of waterbars
2. vehicle access restriction
3. stabilized bleed-offs and preventative waterbars
4. swale with check dams

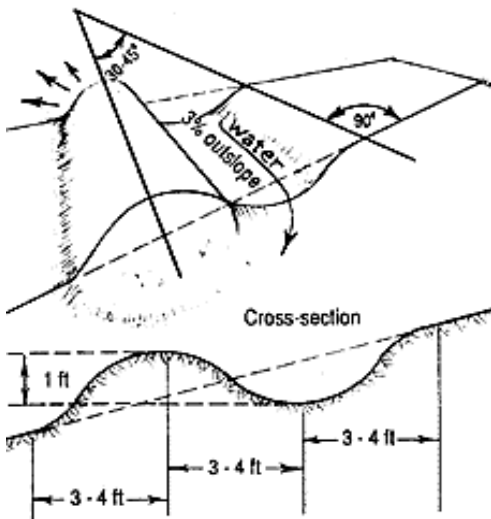

Waterbar Cross Section
(Source: MN Extension Service)

Road Grade	Spacing (ft)		
	Waterbars	Dips	Cross Drains
2%	250	300	135
5%	135	180	100
10%	80	140	80
15%	60	Do not use	60
20%	45		45
25%	40		30

Source: HI DFW (2003) and VICES (2003); Coeur d'Alene RMP/EIS (2006)

Milgie's Grocery Culvert

Great Pond

Project ID: GP-RC-2

Type: Drainage improvement

Description: This project involves the realignment of the east gut flowing through Sally's Fancy and the installation of a culvert below Rt. 624.

While not a priority watershed restoration project, this location is a chronic flooding problem and requires consistent maintenance by DPW. The gut has been impacted by residential development and the direction of flow has been altered at the Rt. 624 crossing.

Culvert sizing calculations have not been done for this concept plan.

Key Design Elements:

1. Install box culvert and raise the road grade as necessary at the point where the gut meets Rt. 624 (prior to diversion along road);
2. Reconnect gut to downstream reach and restore floodplain wetland;
3. Install small wetland/sediment forebay and, potentially, a roadside swale to collect runoff from Milgie's grocery via the existing paved dip; and
4. Conduct residential survey to determine extent of encroachment into gut buffer and look for opportunities for restoration and pollution prevention;

Constraints: None. Existing utility pole threatened by gut erosion and ponding.



Location at Milgie's where East Gut flow is diverted along the parking area and then across Rt. 624 via an existing paved dip.



This area is a flooding nuisance and requires constant maintenance by DPW to clean out area where sediment settles and prevents drainage.



Restore gut and natural wetland/floodplain area.

Site Map:

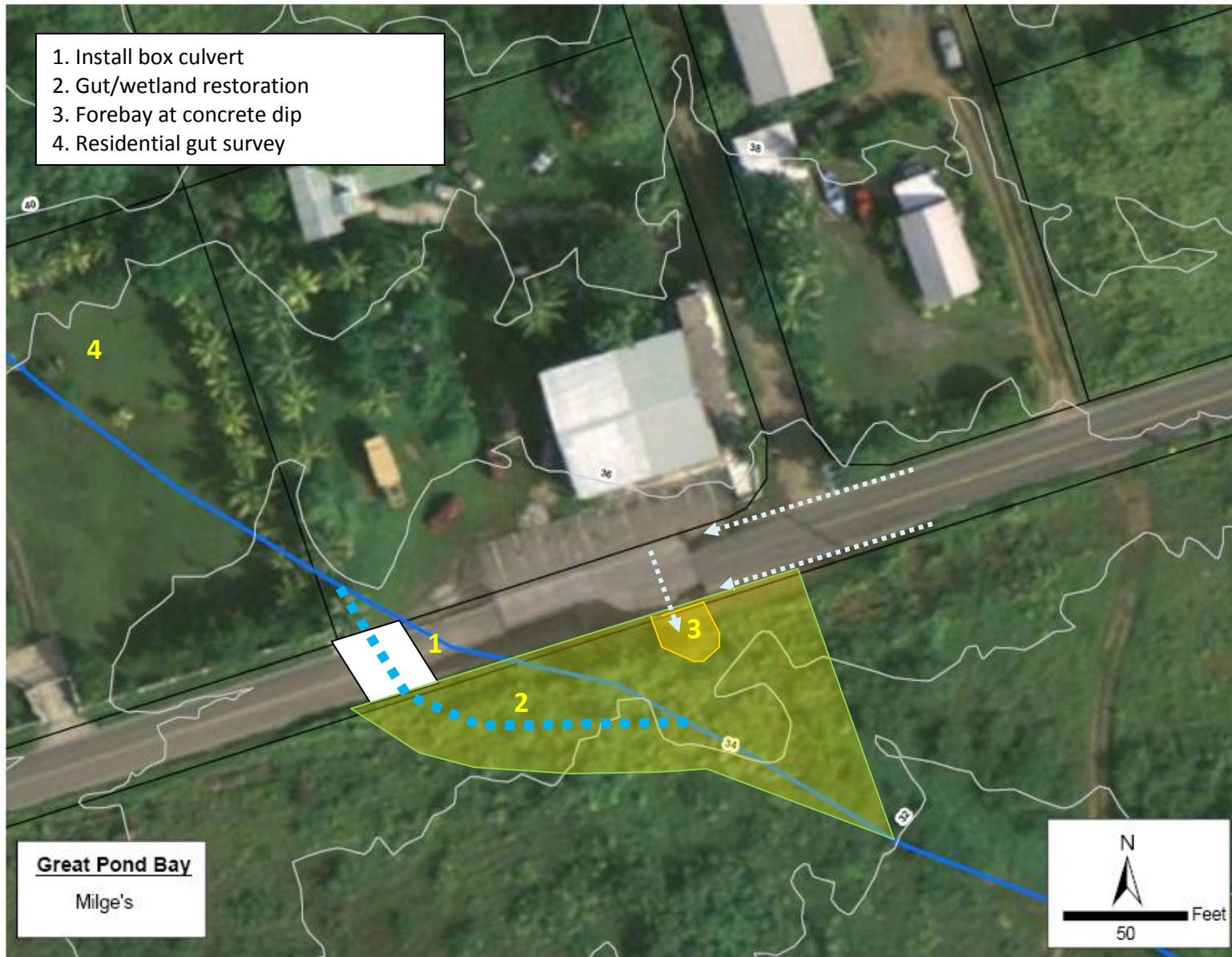

Reef Golf Course Teague Bay

Project ID: TB-R-3A, TB-R-3B, TB-G1

Type: Retrofit; gut stabilization

Description: Concept includes two separate retrofits in combination with gut stabilization and culvert replacement on the Reef Golf Course and Duggan's property. Over 200 acres ultimately drain down to the gut and existing water features on the property. The gut that appears to have historically been relocated to the western edge of the property is actively eroding/widening, particularly where bedrock has been exposed. Sediment deposition at the bottom of the reach has completely blocked the culvert under East End Rd. The concepts include diverting flows from the gut to a new water feature on the golf course, stabilizing the gut, replacing the culvert, and creating a stormwater wetland across East End Rd.

Constraints: There may be permitting issues associated with construction in the gut and in a potential wetland area.

Key Design Elements:

1. Diversion structure:
 - Sends 2-inches of rainfall from gut to the proposed pond
 - Sends all additional rainfall through the gut
2. Pond
 - Designed with a permanent pool elevation of 17.5' (depth of 6.5')
 - Will overtop spillway crest at elevation 18.0' and conveyed back to gut
 - Rim Elevation = 19.0'
 - 4:1 side slopes: 4' berm top width
3. Culvert
 - 3'(H) x 5'(W) concrete box culvert
 - Designed to pass the 5-yr storm event without overtopping roadway
4. Constructed wetland
 - Permanent pool Elevation of 8.0'

- Must remove 12"-18" of existing muck
 - 3:1 side slopes
5. Gut restoration
 - About 600' of restoration required
 - Check dams spaced every 20'-25' when designed at 18" water depths
 - Reinforced with coir fabric

See more detailed design plan set at:
www.horsleywitten.com/stx-east-end-watersheds/designs.html



Gut along western property boundary for golf course.



Proposed location of new water feature.



Area for proposed constructed wetland.

Site Map:

1. Diversion Structure
2. Proposed pond/water feature
3. Culvert Replacement
4. Constructed wetland
5. Gut stabilization

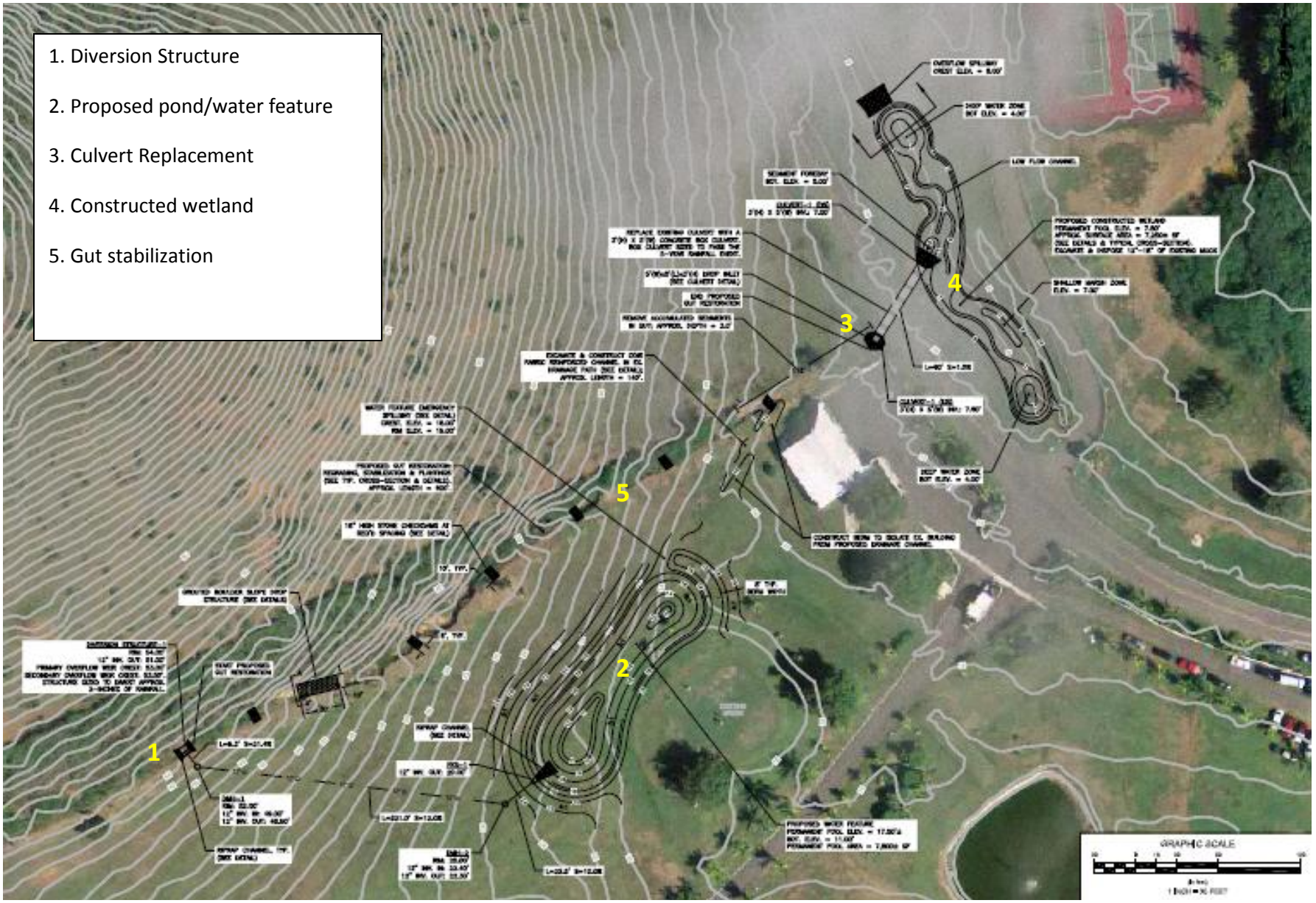

Planning Level Cost Estimate:

**REEF GOLF RESTORATION - GUT DIVERSION & WATER FEATURE
ESTIMATE OF CONSTRUCTION QUANTITIES
ST. CROIX, USVI**

SEPT. 2011

Quantities listed are estimates only and not guaranteed to approximate the actual amounts to be used.

ITEM NUMBER	DESCRIPTION	ESTIMATED QUANTITY	UNIT	MA UNIT PRICE	STX UNIT PRICE	TOTAL AMOUNT
1.01	MOBILIZATION/DEMOBILIZATION	1	LUMP SUM	-	\$9,200.00	\$9,200
1.02	EXCAVATION	1,500	CUBIC YARD	-	\$27.00	\$40,500
1.03	FINE GRADING AND COMPACTION	2,800	SQUARE YARD	\$2.00	\$2.60	\$7,300
1.04	CLEAN SAND	40	CUBIC YARD	\$80.00	\$104.00	\$4,200
1.05	LOAM & SEED	2,300	SQUARE YARD	\$5.00	\$6.50	\$15,000
1.06	CRUSHED STONE	5	CUBIC YARD	\$42.00	\$54.60	\$300
1.07	RIPRAP	6	CUBIC YARD	\$50.00	\$65.00	\$400
1.08	MANHOLE	2	EACH	\$3,000.00	\$3,900.00	\$7,800
1.09	DIVERSION STRUCTURE	1	EACH	\$10,000.00	\$13,000.00	\$13,000
1.10	12" HDPE PIPE	260	LINEAR FOOT	-	\$150.00	\$39,000
1.11	12" FLARED END SECTION	1	EACH	\$1,000.00	\$1,300.00	\$1,300
1.12	FILTER FABRIC	100	SQUARE YARD	\$3.00	\$3.90	\$400
1.13	COIR FABRIC	120	SQUARE YARD	\$8.00	\$10.40	\$1,300

SUB TOTAL \$139,700

ESTIMATED BID PRICE \$ 140,000

Contingency 30% \$ 42,000

ESTIMATED CONSTRUCTION CONTRACT \$182,000

**REEF GOLF RESTORATION - GUT RESTORATION & CULVERT REPLACEMENT
ESTIMATE OF CONSTRUCTION QUANTITIES
ST. CROIX, USVI**

SEPT. 2011

Quantities listed are estimates only and not guaranteed to approximate the actual amounts to be used.

ITEM NUMBER	DESCRIPTION	ESTIMATED QUANTITY	UNIT	MA UNIT PRICE	STX UNIT PRICE	TOTAL AMOUNT
2.01	MOBILIZATION/DEMOBILIZATION	1	LUMP SUM	-	\$8,900.00	\$8,900
2.02	SITE CLEARING & GRUBBING	560	SQUARE YARD	\$2.50	\$3.25	\$1,900
2.03	EXCAVATION	300	CUBIC YARD	-	\$27.00	\$8,100
2.04	FINE GRADING AND COMPACTION	700	SQUARE YARD	\$2.00	\$2.60	\$1,900
2.05	CLEAN SAND	140	CUBIC YARD	\$80.00	\$104.00	\$14,600
2.06	LOAM & SEED	670	SQUARE YARD	\$5.00	\$6.50	\$4,400
2.07	CRUSHED STONE	50	CUBIC YARD	\$42.00	\$54.60	\$2,800
2.08	RIPRAP	100	CUBIC YARD	\$50.00	\$65.00	\$6,500
2.09	BOULDERS FOR DROP STRUCTURE	40	CUBIC YARD	\$200.00	\$260.00	\$10,400
2.10	ASPHALT	12	TONS	-	\$200.00	\$2,400
2.11	CONTROLLED DENSITY FILL	26	CUBIC YARD	-	\$200.00	\$5,200
2.12	3' X 5' CONCRETE BOX CULVERT	60	LINEAR FOOT	-	\$500.00	\$30,000
2.13	REINFORCED CONCRETE HEADWALL/WINGWALLS	2	EACH	\$3,000.00	\$3,900.00	\$7,800
2.14	CONCRETE DROP INLET	1	EACH	\$5,000.00	\$6,500.00	\$6,500
2.15	FILTER FABRIC	200	SQUARE YARD	\$3.00	\$3.90	\$800
2.16	COIR FABRIC	670	SQUARE YARD	\$8.00	\$10.40	\$7,000
2.17	RESTORATION PLANTINGS	1	LUMP SUM	-	\$15,000.00	\$15,000

SUB TOTAL \$134,200

ESTIMATED BID PRICE **\$ 135,000**

Contingency 30% \$ 41,000

ESTIMATED CONSTRUCTION CONTRACT **\$ 176,000**

**REEF GOLF RESTORATION - CONSTRUCTED WETLAND
ESTIMATE OF CONSTRUCTION QUANTITIES
ST. CROIX, USVI**

SEPT. 2011

Quantities listed are estimates only and not guaranteed to approximate the actual amounts to be used.

ITEM NUMBER	DESCRIPTION	ESTIMATED QUANTITY	UNIT	MA UNIT PRICE	STX UNIT PRICE	TOTAL AMOUNT
3.01	MOBILIZATION/DEMOBILIZATION	1	LUMP SUM	-	\$4,300.00	\$4,300
3.02	EXCAVATION	600	CUBIC YARD	-	\$27.00	\$16,200
3.03	FINE GRADING AND COMPACTION	2,000	SQUARE YARD	\$2.00	\$2.60	\$5,200
3.04	LOAM & SEED	1,080	SQUARE YARD	\$5.00	\$6.50	\$7,100
3.05	CRUSHED STONE	3	CUBIC YARD	\$42.00	\$54.60	\$200
3.06	RIPRAP	11	CUBIC YARD	\$50.00	\$65.00	\$800
3.07	FILTER FABRIC	100	SQUARE YARD	\$3.00	\$3.90	\$400
3.08	COIR FABRIC	1,890	SQUARE YARD	\$8.00	\$10.40	\$19,700
3.09	SILT FENCE FOR EROSION CONTROL	50	LINEAR FOOT	-	\$9.00	\$500
3.10	RESTORATION PLANTINGS	1	LUMP SUM	-	\$10,000.00	\$10,000

SUB TOTAL \$64,400

ESTIMATED BID PRICE \$ 65,000

Contingency 30% \$ 20,000

ESTIMATED CONSTRUCTION CONTRACT \$ 85,000

This page intentionally left blank.

Ridge Rd. at Rt. 82

Teague Bay

Project ID: TB-RC-3

Type: Road stabilization

Description: Project concept is to stabilize approximately 600 ft of unpaved road that discharges sediment onto East End Rd. The deterioration of the drainage ditch at the lowest curve is evident, and there is extensive erosion of the road surface just uphill of this bend. This road is a candidate for paving; however, the installation of strategically placed waterbars is also an option.

Key Design Elements:

1. Pave lower section of road; or
2. Install a minimum of 4 waterbars;
3. Stabilized bleed-off at top of bend;
4. Install check dams as necessary in roadside ditch to prevent erosive flows;



Erosion along ditch at bend in road.

Sketch:

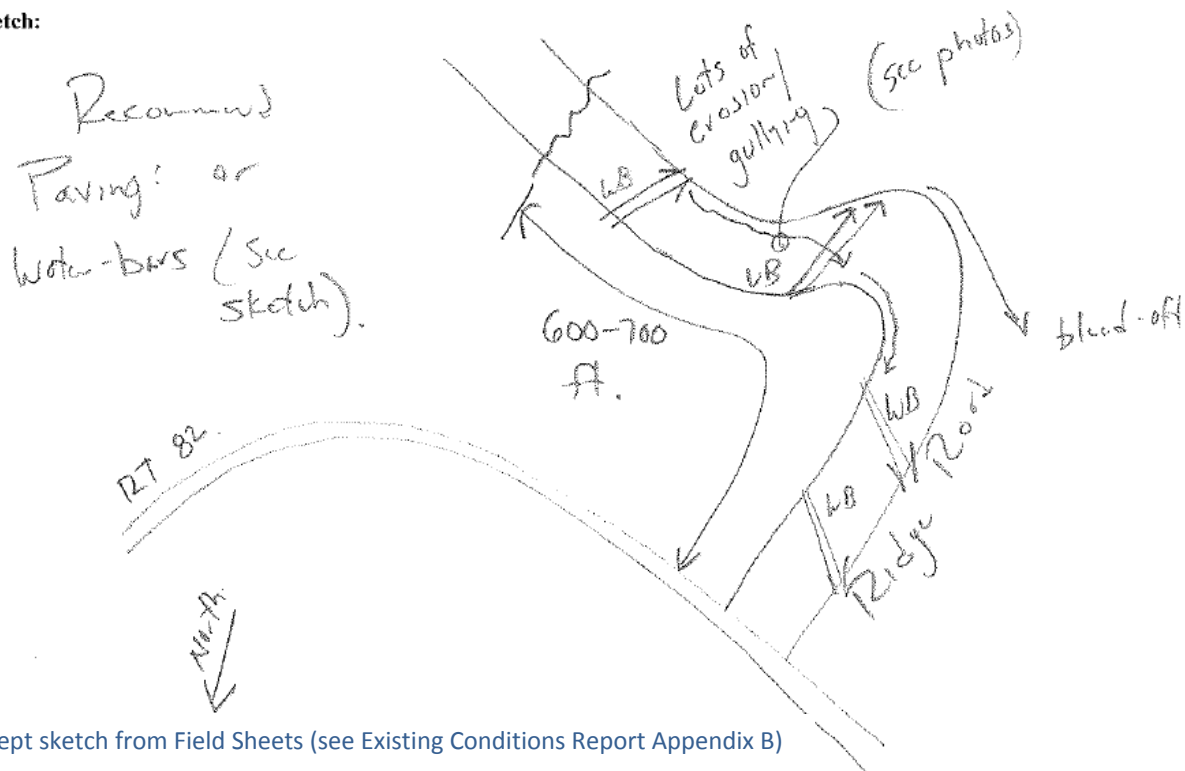

Concept sketch from Field Sheets (see Existing Conditions Report Appendix B)

Site Map

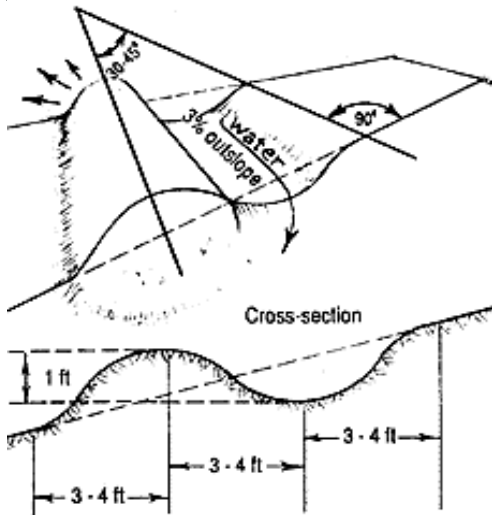
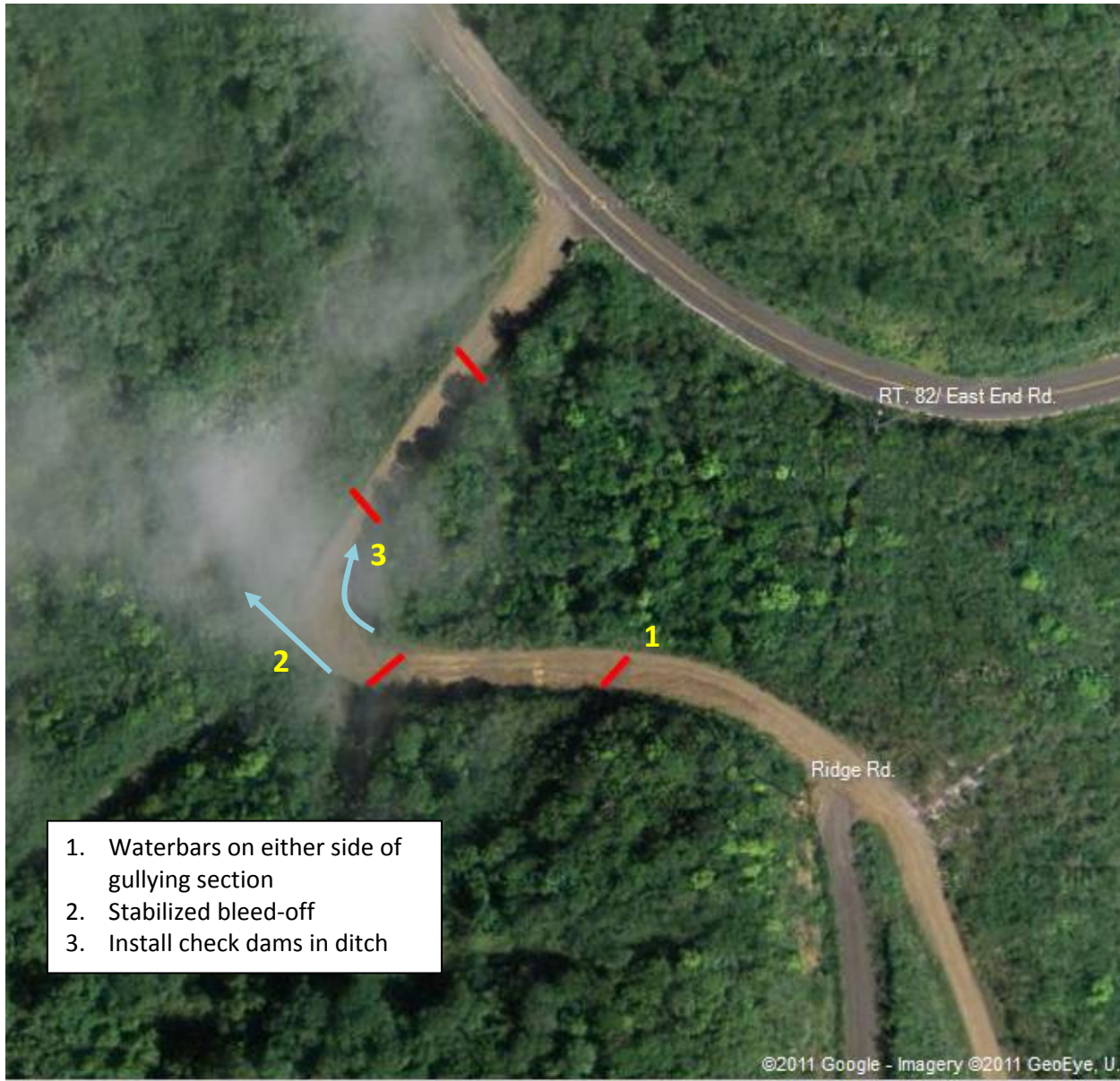

Waterbar Cross Section
(Source: MN Extension Service)

Road Grade	Spacing (ft)		
	Waterbars	Dips	Cross Drains
2%	250	300	135
5%	135	180	100
10%	80	140	80
15%	60	Do not use	60
20%	45		45
25%	40		30

Source: HI DFW (2003) and VICES (2003); Coeur d'Alene RMP/EIS (2006)

Seven Flags Rd.

Solitude Bay

Project ID: SB-R-3; SB-RC-9

Type: Road stabilization, retrofit

Description: Pave 1000 ft of privately-owned road where existing ditch erosion is threatening buildings and utilities and clogging culverts, which causes flooding on East End Rd. The concept for this site also involves redirecting flows into a drainage easement further up the road, installing stepped, detention structures along the conveyance path, and piping overflows to a new culvert under East End Rd. The existing culverts under East End Road take flow from 88.1 acres, 13.8 acres impervious. Preventing road and roadside ditch erosion is the key water quality improvement of this project.

Key Design Elements:

- Divert flows at top of road with paved flume and grass channel into existing gut/drainage easement.
- Pave lower section of road and re-grade to better drain to new catch basins to be installed on the west side of the road.
- Install terraced detention cells (roughly 50 feet wide, 3 feet deep) in channel with amended soils to promote infiltration. Vegetation will be grass, so that vegetative maintenance will be limited.
- At the down-gradient end of the terraced system, install an outlet structure that discharges into a pipe, connecting with proposed road drainage.
- The pipe should be at least 48 inches in diameter to handle the estimated runoff – this will need to be confirmed as the design advances.
- Replace the two existing, damaged 24-inch culverts with two or more 36-inch culverts (depending on design storm).

- On the downstream end, install a stilling basin to reduce erosive velocities. Some clearing and grading will be required for this work since the area is currently wooded. Maintenance access should be provided.



Eroding ditch along lower portion of Seven Flags Rd.



Proposed location for stepped stormwater conveyance.



Existing culverts under East End Rd.

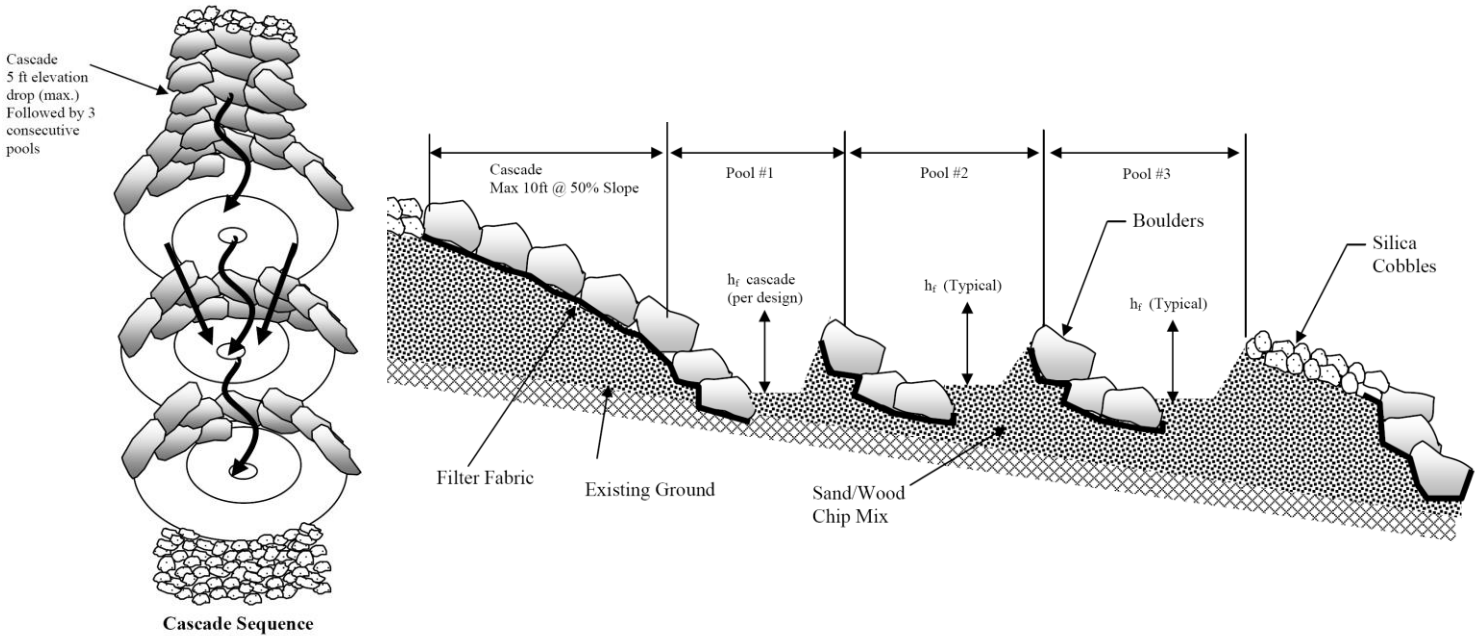

Example plan and profile views of terraced conveyance systems.

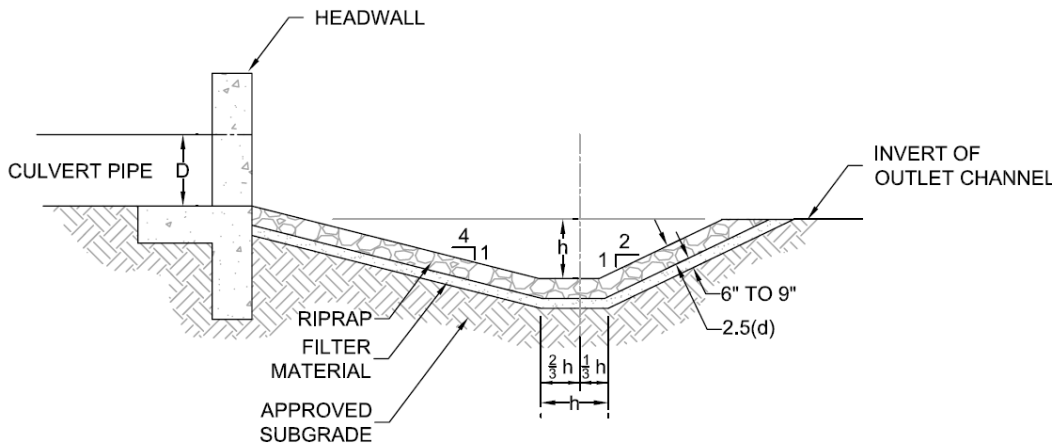

SECTION ALONG CENTERLINE

$$h = \left[0.148 \frac{Q}{D^{1/2} d^{3/2}} - 1.82dD^{1/2} \right]^{2/3}$$

Q = DESIGN DISCHARGE
D = CULVERT DIAMETER
d = RIPRAP d50 SIZE

OUTLET STILLING BASIN / PLUNGE POOL DETAIL

NOT TO SCALE

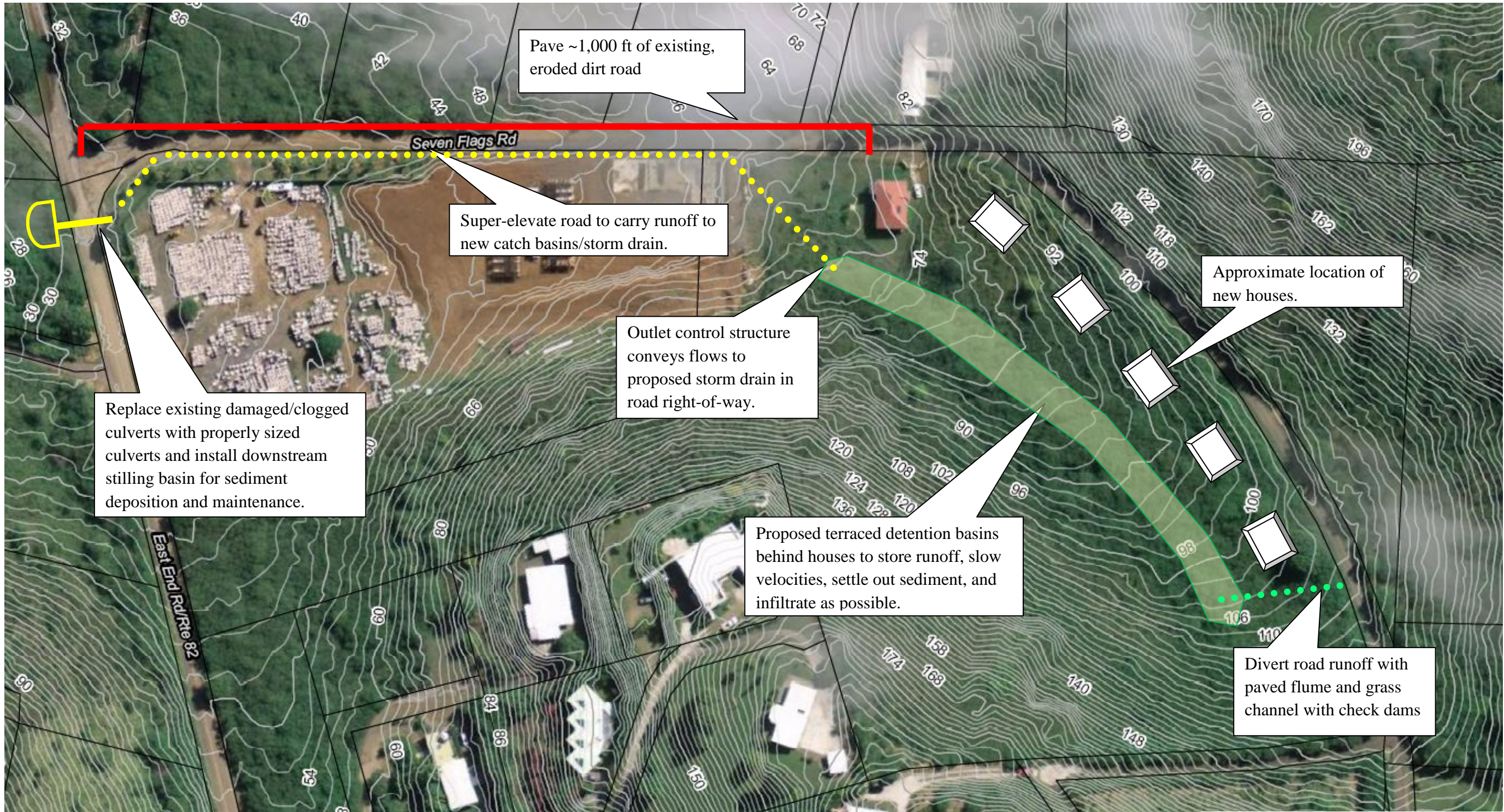

Replace existing damaged/clogged culverts with properly sized culverts and install downstream stilling basin for sediment deposition and maintenance.

Pave ~1,000 ft of existing, eroded dirt road

Super-elevate road to carry runoff to new catch basins/storm drain.

Outlet control structure conveys flows to proposed storm drain in road right-of-way.

Proposed terraced detention basins behind houses to store runoff, slow velocities, settle out sediment, and infiltrate as possible.

Approximate location of new houses.

Divert road runoff with paved flume and grass channel with check dams



Horsley Witten Group, Inc.
Sustainable Environmental Solutions
www.horsleywitten.com
90 Route 6A
Sandwich, MA 02563
508-833-6600 voice
508-833-3150 fax

SB-R-1 Seven Flags Road

CONCEPTUAL DESIGN

St. Croix, USVI

Prepared For:
NOAA Office of Ocean & Coastal Resources Mgt
1305 East-West Hwy, SSMC-4 RM
10414
Silver Spring, MD 20910
Phone: (301) 713-0820
Fax: ---



St. Croix Yacht Club Teague Bay

Project ID: TB-R-2B/A

Type: Retrofit

Description: Retrofit concept includes the expansion and modification of the existing detention basin to improve water quality treatment. The existing facility appears undersized for the amount of area draining to it. Other options for this site include installation of rain gardens in the parking lots and potential permeable pavement installation in small northern parking area.

Key Design Elements:

1. Formalize swale area near entrance and along roadway (investigate additional storage potential);
2. Investigate potential for shallow rain garden in boat storage area;
3. Install waterbar and small shallow rain garden east of clubhouse;
4. Stabilize muddy/unpaved road with gravel and regrade so drains to swale;
5. Install culvert and new wetland forebay prior to discharge to gut.



Formalize existing swale along entrance to expand capacity and perhaps, provide for some storage



Continuation of existing swale.



Area for proposed culvert and wetland forebay prior to discharge into gut.



Install water bar and direct some runoff to a shallow rain garden/landscaped area.

Site Map:

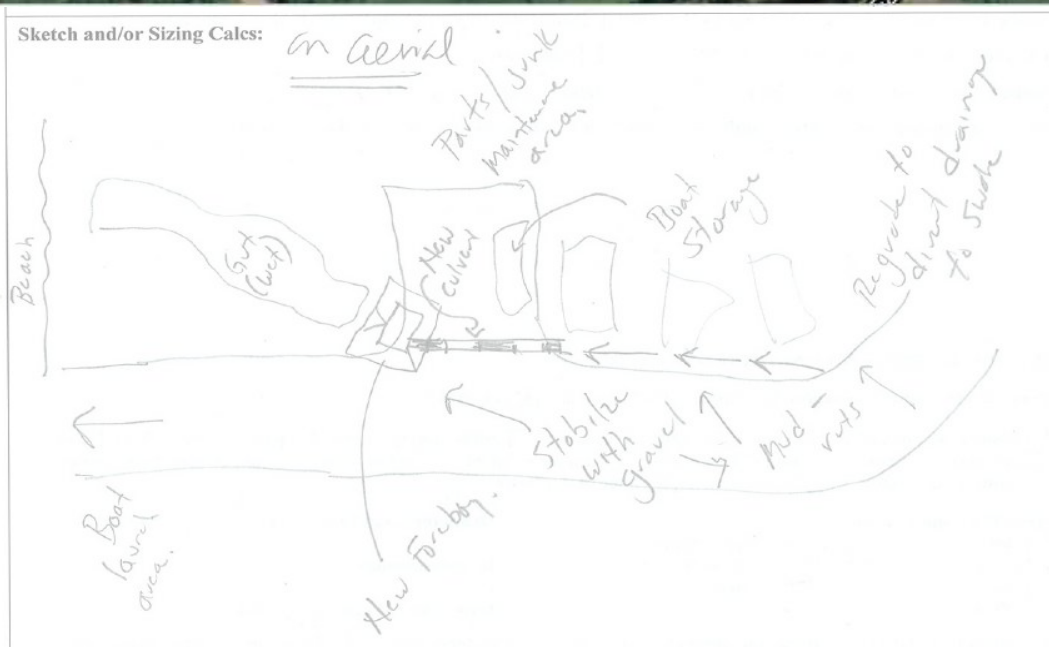

Unnamed Rd.

Great Pond Bay

Project ID: GP-RC-33

Type: Road stabilization

Description: Project concept is to stabilize over 300 ft of unpaved/gravel road that discharges sediment at outlet point across South Shore Rd. The deterioration of the paved surface of South Shore Rd. is evident where runoff from the unnamed road flows across the road surface into the wooded area. Sediment deposition in the wooded area was observed. Public Works has commented on this location as being a chronic problem.

This project, while not ranked as a high watershed restoration priority, provides design examples for options on how to stabilize unpaved road systems.

Key Design Elements:

- Install at least three waterbars along the length of the road to divert flows to swale on north side of road;
- Formalize existing road side swale to accept flows and safely convey to bottom of hill;
- Install check dams as necessary in channel to prevent erosive flows;
- Install culverts at existing driveways;
- Install a drop inlet structure with sump in the road-right-of way on the corner of South Shore Rd to collect sediment; and
- Install a culvert under South Shore Rd. to convey flows from inlet to a stabilized outlet structure with level spreader or stilling basin.
- Repave cut section of South Shore Rd.



Unnamed gravel road off of South Shore Rd. next to Washington Ln.



Sediment deposition at outlet location.



Surface deterioration of South Shore Rd.

Waterbar Design Criteria:

- Excavate trench at 30-45 degree angle across the road surface. Steeper grades with more surface flow should be closer to 45 degrees.
- Top of berm should be 12 inches higher than bottom of trench. To make a water bar easier to drive over, widen it by increasing the distance between the bottom of the dip and the top of the berm, maintaining the correct height.
- Pitch of waterbar is such that outlet end is at least 3 inches lower than the upper end (~3% slope).
- Extend waterbars beyond both travel edges of road to prevent water from flowing around ends.
- Direct diverted water into a stable, vegetated area or ditch. Do not discharge cross drains, culverts, water bars, dips, and other drainage structures onto erodible soils or fill slopes without outfall protection (rock piles, logs, etc.).

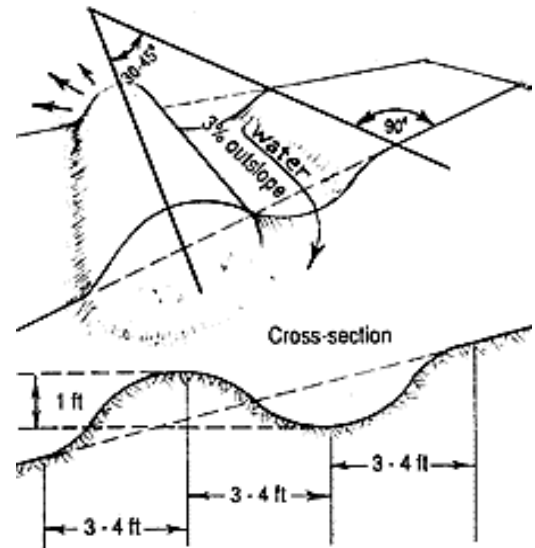

Waterbar Cross Section
(Source: MN Extension Service)

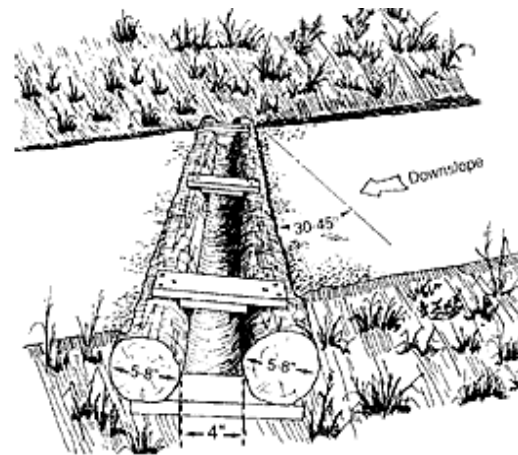

Water Trench
(Source: MN Extension Service)

Recommended Spacing of Waterbars and Cross Drains

Road Grade	Spacing (ft)		
	Waterbars	Dips	Cross Drains
2%	250	300	135
5%	135	180	100
10%	80	140	80
15%	60	Do not use	60
20%	45		45
25%	40		30

Source: HI DFW (2003) and VICIS (2003); Coeur d'Alene RMP/EIS (2006)

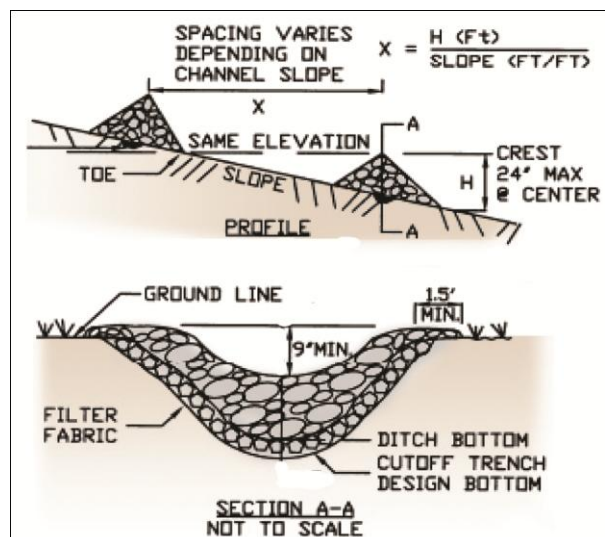

Check Dam Spacing and Cross Section

Water Bar Details

Detail A

N.T.S.

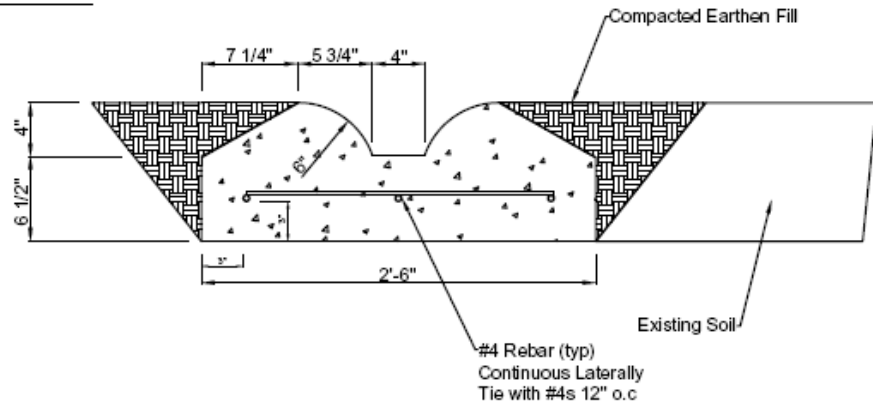

Detail B

N.T.S.

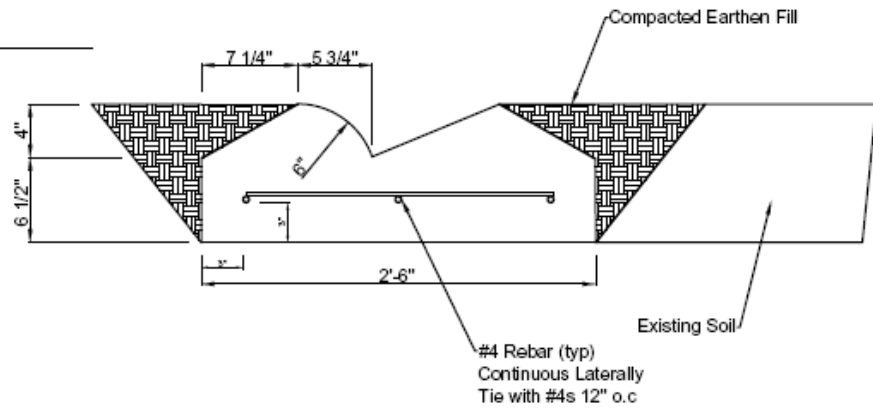

Detail C

N.T.S.

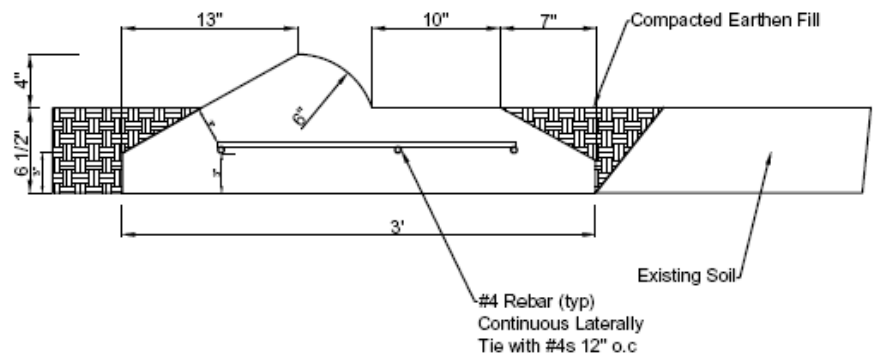

This page left intentionally blank.

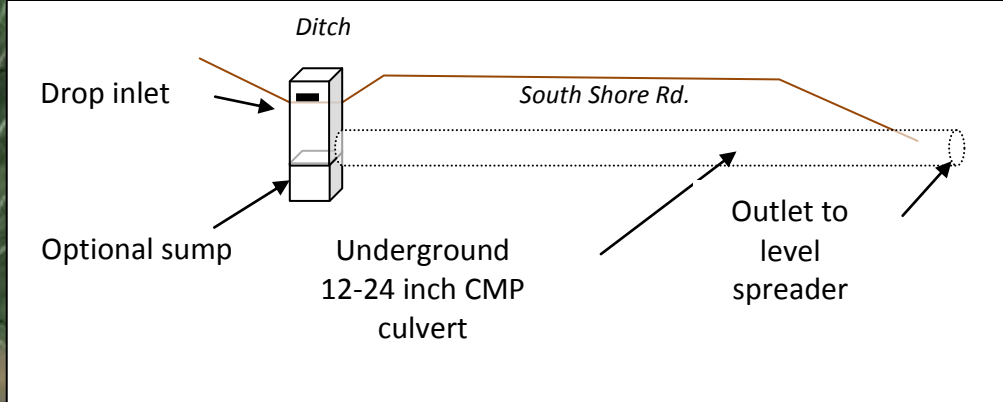
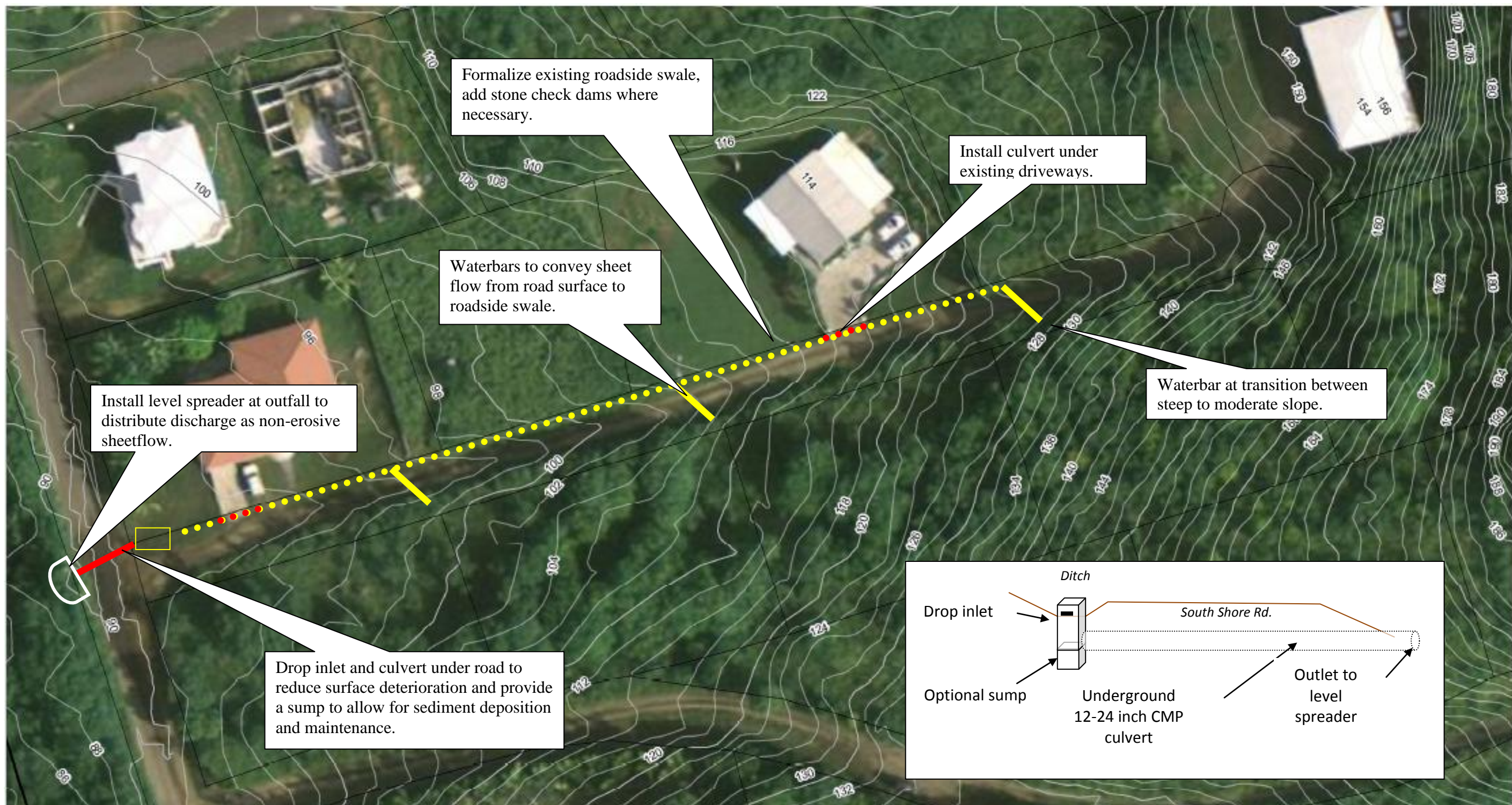

Horsley Witten Group, Inc.
 Sustainable Environmental Solutions
 www.horsleywitten.com
 90 Route 6A
 Sandwich, MA 02563
 508-833-6600 voice
 508-833-3150 fax

GP-RC-33 Un-named Road
 (Off Southshore Rd./Washington Ln.)
CONCEPTUAL DESIGN
 St. Croix, USVI

Prepared For:
 NOAA Office of Ocean &
 Coastal Resources Mgt
 1305 East-West Hwy, SSMC-4 RM
 10414
 Silver Spring, MD 20910
 Phone: (301) 713-0820
 Fax: ---

